

# INSTRUCTOR'S SOLUTIONS MANUAL

FUNDAMENTALS OF DIFFERENTIAL EQUATIONS

SEVENTH EDITION

AND

FUNDAMENTALS OF DIFFERENTIAL EQUATIONS

AND BOUNDARY VALUE PROBLEMS

FIFTH EDITION

**R. Kent Nagle**

*University of South Florida*

**Edward B. Saff**

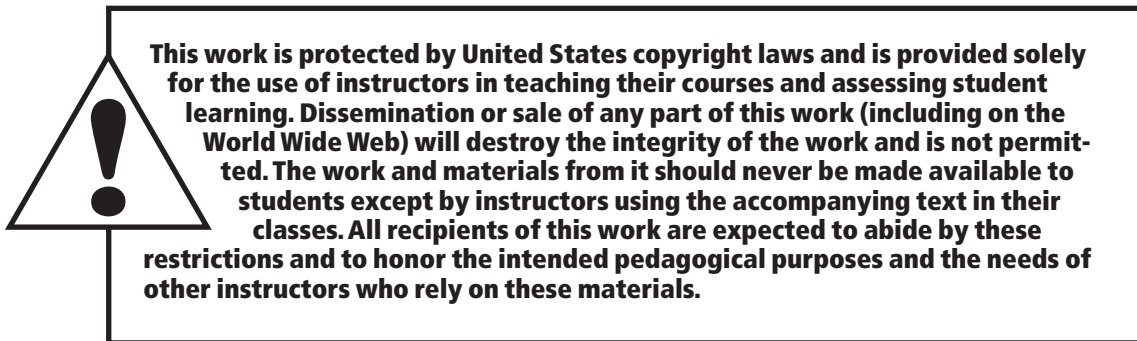
*Vanderbilt University*

**A. David Snider**

*University of South Florida*



Boston San Francisco New York  
London Toronto Sydney Tokyo Singapore Madrid  
Mexico City Munich Paris Cape Town Hong Kong Montreal



Reproduced by Pearson Addison-Wesley from electronic files supplied by the author.

Copyright © 2008 Pearson Education, Inc.

Publishing as Pearson Addison-Wesley, 75 Arlington Street, Boston, MA 02116.

All rights reserved. No part of this publication may be reproduced, stored in a retrieval system, or transmitted, in any form or by any means, electronic, mechanical, photocopying, recording, or otherwise, without the prior written permission of the publisher.

ISBN-13: 978-0-321-38844-5

ISBN-10: 0-321-38844-5



# Contents

<b>Notes to the Instructor</b>	<b>1</b>
Software Supplements . . . . .	1
Computer Labs . . . . .	1
Group Projects . . . . .	2
Technical Writing Exercises . . . . .	2
Student Presentations . . . . .	2
Homework Assignments . . . . .	3
Syllabus Suggestions . . . . .	3
Numerical, Graphical, and Qualitative Methods . . . . .	4
Engineering/Physics Applications . . . . .	5
Biology/Ecology Applications . . . . .	7
<b>Supplemental Group Projects</b>	<b>9</b>
<b>Detailed Solutions &amp; Answers to Even-Numbered Problems</b>	<b>17</b>
<b>CHAPTER 1 Introduction</b>	<b>17</b>
Exercises 1.1 <i>Detailed Solutions</i> . . . . .	17
Exercises 1.2 <i>Detailed Solutions</i> . . . . .	18
Exercises 1.3 <i>Detailed Solutions</i> . . . . .	22
Exercises 1.4 <i>Detailed Solutions</i> . . . . .	25
Tables . . . . .	28
Figures . . . . .	29
<b>CHAPTER 2 First Order Differential Equations</b>	<b>35</b>
Exercises 2.2 <i>Detailed Solutions</i> . . . . .	35
Exercises 2.3 <i>Detailed Solutions</i> . . . . .	41
Exercises 2.4 <i>Detailed Solutions</i> . . . . .	48
Exercises 2.5 <i>Detailed Solutions</i> . . . . .	56
Exercises 2.6 <i>Detailed Solutions</i> . . . . .	61
Review Problems <i>Answers</i> . . . . .	70
Tables . . . . .	71
Figures . . . . .	71

<b>CHAPTER 3</b>	<b>Mathematical Models and Numerical Methods</b>	<b>73</b>
	<b>Involving First Order Equations</b>	
Exercises 3.2	<i>Detailed Solutions</i>	73
Exercises 3.3	<i>Detailed Solutions</i>	81
Exercises 3.4	<i>Detailed Solutions</i>	87
Exercises 3.5	<i>Answers</i>	96
Exercises 3.6	<i>Answers</i>	97
Exercises 3.7	<i>Answers</i>	97
Tables		98
Figures		100
<b>CHAPTER 4</b>	<b>Linear Second Order Equations</b>	<b>101</b>
Exercises 4.1	<i>Detailed Solutions</i>	101
Exercises 4.2	<i>Detailed Solutions</i>	103
Exercises 4.3	<i>Detailed Solutions</i>	111
Exercises 4.4	<i>Detailed Solutions</i>	119
Exercises 4.5	<i>Detailed Solutions</i>	125
Exercises 4.6	<i>Detailed Solutions</i>	137
Exercises 4.7	<i>Detailed Solutions</i>	144
Exercises 4.8	<i>Detailed Solutions</i>	157
Exercises 4.9	<i>Detailed Solutions</i>	160
Exercises 4.10	<i>Detailed Solutions</i>	167
Review Problems	<i>Answers</i>	172
Figures		173
<b>CHAPTER 5</b>	<b>Introduction to Systems and Phase Plane Analysis</b>	<b>177</b>
Exercises 5.2	<i>Answers</i>	177
Exercises 5.3	<i>Answers</i>	179
Exercises 5.4	<i>Answers</i>	180
Exercises 5.5	<i>Answers</i>	182
Exercises 5.6	<i>Answers</i>	182
Exercises 5.7	<i>Answers</i>	183
Exercises 5.8	<i>Answers</i>	183
Review Problems	<i>Answers</i>	184
Tables		185
Figures		187
<b>CHAPTER 6</b>	<b>Theory of Higher-Order Linear Differential Equations</b>	<b>193</b>
Exercises 6.1	<i>Answers</i>	193
Exercises 6.2	<i>Answers</i>	194
Exercises 6.3	<i>Answers</i>	194
Exercises 6.4	<i>Answers</i>	195

Review Problems <i>Answers</i> . . . . .	196
<b>CHAPTER 7 Laplace Transforms</b>	<b>197</b>
Exercises 7.2 <i>Detailed Solutions</i> . . . . .	197
Exercises 7.3 <i>Detailed Solutions</i> . . . . .	201
Exercises 7.4 <i>Detailed Solutions</i> . . . . .	206
Exercises 7.5 <i>Detailed Solutions</i> . . . . .	215
Exercises 7.6 <i>Detailed Solutions</i> . . . . .	224
Exercises 7.7 <i>Detailed Solutions</i> . . . . .	239
Exercises 7.8 <i>Detailed Solutions</i> . . . . .	247
Exercises 7.9 <i>Detailed Solutions</i> . . . . .	252
Review Problems <i>Answers</i> . . . . .	262
Figures . . . . .	263
<b>CHAPTER 8 Series Solutions of Differential Equations</b>	<b>267</b>
Exercises 8.1 <i>Answers</i> . . . . .	267
Exercises 8.2 <i>Answers</i> . . . . .	268
Exercises 8.3 <i>Answers</i> . . . . .	269
Exercises 8.4 <i>Answers</i> . . . . .	270
Exercises 8.5 <i>Answers</i> . . . . .	271
Exercises 8.6 <i>Answers</i> . . . . .	271
Exercises 8.7 <i>Answers</i> . . . . .	273
Exercises 8.8 <i>Answers</i> . . . . .	274
Review Problems <i>Answers</i> . . . . .	275
Figures . . . . .	276
<b>CHAPTER 9 Matrix Methods for Linear Systems</b>	<b>277</b>
Exercises 9.1 <i>Answers</i> . . . . .	277
Exercises 9.2 <i>Answers</i> . . . . .	277
Exercises 9.3 <i>Answers</i> . . . . .	278
Exercises 9.4 <i>Answers</i> . . . . .	280
Exercises 9.5 <i>Answers</i> . . . . .	282
Exercises 9.6 <i>Answers</i> . . . . .	285
Exercises 9.7 <i>Answers</i> . . . . .	286
Exercises 9.8 <i>Answers</i> . . . . .	287
Review Problems <i>Answers</i> . . . . .	289
Figures . . . . .	290
<b>CHAPTER 10 Partial Differential Equations</b>	<b>291</b>
Exercises 10.2 <i>Answers</i> . . . . .	291
Exercises 10.3 <i>Answers</i> . . . . .	291
Exercises 10.4 <i>Answers</i> . . . . .	292

Exercises 10.5	<i>Answers</i>	293
Exercises 10.6	<i>Answers</i>	294
Exercises 10.7	<i>Answers</i>	295
<b>CHAPTER 11</b>	<b>Eigenvalue Problems and Sturm-Liouville Equations</b>	<b>297</b>
Exercises 11.2	<i>Answers</i>	297
Exercises 11.3	<i>Answers</i>	298
Exercises 11.4	<i>Answers</i>	298
Exercises 11.5	<i>Answers</i>	299
Exercises 11.6	<i>Answers</i>	300
Exercises 11.7	<i>Answers</i>	302
Exercises 11.8	<i>Answers</i>	303
Review Problems	<i>Answers</i>	303
<b>CHAPTER 12</b>	<b>Stability of Autonomous Systems</b>	<b>305</b>
Exercises 12.2	<i>Answers</i>	305
Exercises 12.3	<i>Answers</i>	305
Exercises 12.4	<i>Answers</i>	306
Exercises 12.5	<i>Answers</i>	306
Exercises 12.6	<i>Answers</i>	307
Exercises 12.7	<i>Answers</i>	307
Review Problems	<i>Answers</i>	308
Figures		309
<b>CHAPTER 13</b>	<b>Existence and Uniqueness Theory</b>	<b>317</b>
Exercises 13.1	<i>Answers</i>	317
Exercises 13.2	<i>Answers</i>	317
Exercises 13.3	<i>Answers</i>	318
Exercises 13.4	<i>Answers</i>	318
Review Problems	<i>Answers</i>	318

## Notes to the Instructor

One goal in our writing has been to create flexible texts that afford the instructor a variety of topics and make available to the student an abundance of practice problems and projects. We recommend that the instructor read the discussion given in the preface in order to gain an overview of the prerequisites, topics of emphasis, and general philosophy of the text.

### Software Supplements

**Interactive Differential Equations CD-ROM:** By Beverly West (Cornell University), Steven Strogatz (Cornell University), Jean Marie McDill (California Polytechnic State University – San Luis Obispo), John Cantwell (St. Louis University), and Hubert Hohn (Massachusetts College of Arts) is a popular software directly tied to the text that focuses on helping students visualize concepts. Applications are drawn from engineering, physics, chemistry, and biology. Runs on Windows or Macintosh and is included free with every book.

**Instructor's MAPLE/MATHLAB/MATHEMATICA manual:** By Thomas W. Polaski (Winthrop University), Bruno Welfert (Arizona State University), and Maurino Bautista (Rochester Institute of Technology). A collection of worksheets and projects to aid instructors in integrating computer algebra systems into their courses. Available via Addison-Wesley Instructor's Resource Center.

MATLAB Manual ISBN 13: 978-0-321-53015-8; ISBN 10: 0-321-53015-2

MAPLE Manual ISBN 13: 978-0-321-38842-1; ISBN 10: 0-321-38842-9

MATHEMATICA Manual ISBN 13: 978-0-321-52178-1; ISBN 10: 0-321-52178-1

### Computer Labs

A computer lab in connection with a differential equations course can add a whole new dimension to the teaching and learning of differential equations. As more and more colleges and universities set up computer labs with software such as MAPLE, MATLAB, DERIVE, MATHEMATICA, PHASEPLANE, and MACMATH, there will be more opportunities to include a lab as part of the differential equations course. In our teaching and in our texts, we have tried to provide a variety of exercises, problems, and projects that encourage the student to use the computer to explore. Even one or two hours at a computer generating phase plane diagrams can provide the students with a feeling of how they will use technology together

with the theory to investigate real world problems. Furthermore, our experience is that they thoroughly enjoy these activities. Of course, the software, provided free with the texts, is especially convenient for such labs.

## **Group Projects**

Although the projects that appear at the end of the chapters in the text can be worked out by the conscientious student working alone, making them *group* projects adds a social element that encourages discussion and interactions that simulate a professional work place atmosphere. Group sizes of 3 or 4 seem to be optimal. Moreover, requiring that each individual student separately write up the group's solution as a formal technical report for grading by the instructor also contributes to the professional flavor.

Typically, our students each work on 3 or 4 projects per semester. If class time permits, oral presentations by the groups can be scheduled and help to improve the communication skills of the students.

The role of the instructor is, of course, to help the students solve these elaborate problems on their own and to recommend additional reference material when appropriate. Some additional Group Projects are presented in this guide (see page 9).

## **Technical Writing Exercises**

The technical writing exercises at the end of most chapters invite students to make documented responses to questions dealing with the concepts in the chapter. This not only gives students an opportunity to improve their writing skills, but it helps them organize their thoughts and better understand the new concepts. Moreover, many questions deal with critical thinking skills that will be useful in their careers as engineers, scientists, or mathematicians.

Since most students have little experience with technical writing, it may be necessary to return *ungraded* the first few technical writing assignments with comments and have the students redo the the exercise. This has worked well in our classes and is much appreciated by the students. Handing out a “model” technical writing response is also helpful for the students.

## **Student Presentations**

It is not uncommon for an instructor to have students go to the board and present a solution



to a problem. Differential equations is so rich in theory and applications that it is an excellent course to allow (require) a student to give a presentation on a special application (e.g., almost any topic from Chapter 3 and 5), on a new technique not covered in class (e.g., material from Section 2.6, Projects A, B, or C in Chapter 4), or on additional theory (e.g., material from Chapter 6 which generalizes the results in Chapter 4). In addition to improving students' communication skills, these "special" topics are long remembered by the students. Here, too, working in groups of 3 or 4 and sharing the presentation responsibilities can add substantially to the interest and quality of the presentation. Students should also be encouraged to enliven their communication by building physical models, preparing part of their lectures on video cassette, etc.

## **Homework Assignments**

We would like to share with you an obvious, non-original, but effective method to encourage students to do homework problems.

An essential feature is that it requires little extra work on the part of the instructor or grader. We assign homework problems (about 10 of them) after each lecture. At the end of the week (Fridays), students are asked to turn in their homework (typically, 3 sets) for that week. We then choose at random one problem from each assignment (typically, a total of 3) that will be graded. (The point is that the student does not know in advance which problems will be chosen.) Full credit is given for any of the chosen problems for which there is evidence that the student has made an honest attempt at solving. The homework problem sets are returned to the students at the next meeting (Mondays) with grades like 0/3, 1/3, 2/3, or 3/3 indicating the proportion of problems for which the student received credit. The homework grades are tallied at the end of the semester and count as one test grade. Certainly, there are variations on this theme. The point is that students are motivated to do their homework with little additional cost (= time) to the instructor.

## **Syllabus Suggestions**

To serve as a guide in constructing a syllabus for a one-semester or two-semester course, the prefaces to the texts list sample outlines that emphasize methods, applications, theory, partial differential equations, phase plane analysis, computation, or combinations of these. As a further guide in making a choice of subject matter, we provide below a listing of text material dealing with some common areas of emphasis.

## Numerical, Graphical, and Qualitative Methods

The sections and projects dealing with numerical, graphical, and qualitative techniques of solving differential equations include:

Section 1.3: *Direction Fields*

Section 1.4: *The Approximation Method of Euler*

Project A for Chapter 1: *Taylor Series*

Project B for Chapter 1: *Picard's Method*

Project D for Chapter 1: *The Phase Line*

Section 3.6: *Improved Euler's Method*, which includes step-by-step outlines of the improved Euler's method subroutine and improved Euler's method with tolerance. These outlines are easy for the student to translate into a computer program (cf. pages 135 and 136).

Section 3.7: *Higher-Order Numerical Methods: Taylor and Runge-Kutta*, which includes outlines for the Fourth Order Runge-Kutta subroutine and algorithm with tolerance (see pages 144 and 145).

Project H for Chapter 3: *Stability of Numerical Methods*

Project I for Chapter 3: *Period Doubling and Chaos*

Section 4.8: *Qualitative Considerations for Variable Coefficient and Nonlinear Equations*, which discusses the energy integral lemma, as well as the Airy, Bessel, Duffing, and van der Pol equations.

Section 5.3: *Solving Systems and Higher-Order Equations Numerically*, which describes the vectorized forms of Euler's method and the Fourth Order Runge-Kutta method, and discusses an application to population dynamics.

Section 5.4: *Introduction to the Phase Plane*, which introduces the study of trajectories of autonomous systems, critical points, and stability.

Section 5.8: *Dynamical Systems, Poincarè Maps, and Chaos*, which discusses the use of numerical methods to approximate the Poincarè map and how to interpret the results.

Project A for Chapter 5: *Designing a Landing System for Interplanetary Travel*

Project B for Chapter 5: *Things That Bob*

Project D for Chapter 5: *Strange Behavior of Competing Species – Part I*

Project D for Chapter 9: *Strange Behavior of Competing Species – Part II*

Project D for Chapter 10: *Numerical Method for  $\Delta u = f$  on a Rectangle*

Project D for Chapter 11: *Shooting Method*

Project E for Chapter 11: *Finite-Difference Method for Boundary Value Problems*

Project C for Chapter 12: *Computing Phase Plane Diagrams*

Project D for Chapter 12: *Ecosystem of Planet GLIA-2*

Appendix A: *Newton’s Method*

Appendix B: *Simpson’s Rule*

Appendix D: *Method of Least Squares*

Appendix E: *Runge-Kutta Procedure for Equations*

The instructor who wishes to emphasize numerical methods should also note that the text contains an extensive chapter of series solutions of differential equations (Chapter 8).

## **Engineering/Physics Applications**

Since Laplace transforms is a subject vital to engineering, we have included a detailed chapter on this topic – see Chapter 7. Stability is also an important subject for engineers, so we have included an introduction to the subject in Chapter 5.4 along with an entire chapter addressing this topic – see Chapter 12. Further material dealing with engineering/physics applications include:

Project C for Chapter 1: *Magnetic “Dipole”*

Project B for Chapter 2: *Torricelli's Law of Fluid Flow*

Section 3.1: *Mathematical Modeling*

Section 3.2: *Compartmental Analysis*, which contains a discussion of mixing problems and of population models.

Section 3.3: *Heating and Cooling Buildings*, which discusses temperature variations in the presence of air conditioning or furnace heating.

Section 3.4: *Newtonian Mechanics*

Section 3.5: *Electrical Circuits*

Project C for Chapter 3: *Curve of Pursuit*

Project D for Chapter 3: *Aircraft Guidance in a Crosswind*

Project E for Chapter 3: *Feedback and the Op Amp*

Project F for Chapter 3: *Band-Bang Controls*

Section 4.1: *Introduction: Mass-Spring Oscillator*

Section 4.8: *Qualitative Considerations for Variable-Coefficient and Nonlinear Equations*

Section 4.9: *A Closer Look at Free Mechanical Vibrations*

Section 4.10: *A Closer Look at Forced Mechanical Vibrations*

Project B for Chapter 4: *Apollo Reentry*

Project C for Chapter 4: *Simple Pendulum*

Chapter 5: *Introduction to Systems and Phase Plane Analysis*, which includes sections on coupled mass-spring systems, electrical circuits, and phase plane analysis.

Project A for Chapter 5: *Designing a Landing System for Interplanetary Travel*

Project B for Chapter 5: *Things that Bob*

Project C for Chapter 5: *Hamiltonian Systems*

Project D for Chapter 5: *Transverse Vibrations of a Beam*

Chapter 7: *Laplace Transforms*, which in addition to basic material includes discussions of transfer functions, the Dirac delta function, and frequency response modeling.

Projects for Chapter 8, dealing with Schrödinger's equation, bucking of a tower, and again springs.

Project B for Chapter 9: *Matrix Laplace Transform Method*

Project C for Chapter 9: *Undamped Second-Order Systems*

Chapter 10: *Partial Differential Equations*, which includes sections on Fourier series, the heat equation, wave equation, and Laplace's equation.

Project A for Chapter 10: *Steady-State Temperature Distribution in a Circular Cylinder*

Project B for Chapter 10: *A Laplace Transform Solution of the Wave Equation*

Project A for Chapter 11: *Hermite Polynomials and the Harmonic Oscillator*

Section 12.4: *Energy Methods*, which addresses both conservative and nonconservative autonomous mechanical systems.

Project A for Chapter 12: *Solitons and Korteweg-de Vries Equation*

Project B for Chapter 12: *Burger's Equation*

Students of engineering and physics would also find Chapter 8 on series solutions particularly useful, especially Section 8.8 on special functions.

## **Biology/Ecology Applications**

Project D for Chapter 1: *The Phase Plane*, which discusses the logistic population model and bifurcation diagrams for population control.

Project A for Chapter 2: *Differential Equations in Clinical Medicine*

Section 3.1: *Mathematical Modeling*

Section 3.2: *Compartmental Analysis*, which contains a discussion of mixing problems and population models.

Project A for Chapter 3: *Dynamics for HIV Infection*

Project B for Chapter 3: *Aquaculture*, which deals with a model of raising and harvesting catfish.

Section 5.1: *Interconnected Fluid Tanks*, which introduces systems of equations.

Section 5.3: *Solving Systems and Higher-Order Equations Numerically*, which contains an application to population dynamics.

Section 5.5: *Applications to Biomathematics: Epidemic and Tumor Growth Models*

Project D for Chapter 5: *Strange Behavior of Competing Species – Part I*

Project E for Chapter 5: *Cleaning Up the Great Lakes*

Project D for Chapter 9: *Strange Behavior of Competing Species – Part II*

Problem 19 in Exercises 10.5, which involves chemical diffusion through a thin layer.

Project D for Chapter 12: *Ecosystem on Planet GLIA-2*

The basic content of the remainder of this instructor’s manual consists of supplemental group projects, answers to the even-numbered problems, and detailed solutions to the even-numbered problems in Chapters 1, 2, 4, and 7 as well as Sections 3.2, 3.3, and 3.4. The answers are, for the most part, not available any place else since the text only provides answers to odd-numbered problems, and the *Student’s Solutions Manual* contains only a handful of worked solutions to even-numbered problems.

We would appreciate any comments you may have concerning the answers in this manual. These comments can be sent to the authors’ email addresses below. We also would encourage sharing with us (= the authors and users of the texts) any of your favorite group projects.

E. B. Saff  
Edward.B.Saff@Vanderbilt.edu

A. D. Snider  
snider@eng.usf.edu

## Group Projects for Chapter 3

### Delay Differential Equations

In our discussion of mixing problems in Section 3.2, we encountered the initial value problem

$$\begin{aligned}x'(t) &= 6 - \frac{3}{500} x(t - t_0), \\x(t) &= 0 \quad \text{for } x \in [-t_0, 0],\end{aligned}\tag{0.1}$$

where  $t_0$  is a positive constant. The equation in (0.1) is an example of a **delay differential equation**. These equations differ from the usual differential equations by the presence of the shift  $(t - t_0)$  in the argument of the unknown function  $x(t)$ . In general, these equations are more difficult to work with than are regular differential equations, but quite a bit is known about them.<sup>1</sup>

(a) Show that the simple linear delay differential equation

$$x' = ax(t - b),\tag{0.2}$$

where  $a, b$  are constants, has a solution of the form  $x(t) = Ce^{st}$  for any constant  $C$ , provided  $s$  satisfies the transcendental equation  $s = ae^{-bs}$ .

(b) A solution to (0.2) for  $t > 0$  can also be found using the **method of steps**. Assume that  $x(t) = f(t)$  for  $-b \leq t \leq 0$ . For  $0 \leq t \leq b$ , equation (0.2) becomes

$$x'(t) = ax(t - b) = af(t - b),$$

and so

$$x(t) = \int_0^t af(\nu - b)d\nu + x(0).$$

Now that we know  $x(t)$  on  $[0, b]$ , we can repeat this procedure to obtain

$$x(t) = \int_b^t ax(\nu - b)d\nu + x(b)$$

for  $b \leq x \leq 2b$ . This process can be continued indefinitely.

---

<sup>1</sup>See, for example, *Differential-Difference Equations*, by R. Bellman and K. L. Cooke, Academic Press, New York, 1963, or *Ordinary and Delay Differential Equations*, by R. D. Driver, Springer-Verlag, New York, 1977

Use the method of steps to show that the solution to the initial value problem

$$x'(t) = -x(t-1), \quad x(t) = 1 \quad \text{on} \quad [-1, 0],$$

is given by

$$x(t) = \sum_{k=0}^n (-1)^k \frac{[t - (k-1)]^k}{k!}, \quad \text{for } n-1 \leq t \leq n,$$

where  $n$  is a nonnegative integer. (This problem can also be solved using the Laplace transform method of Chapter 7.)

- (c) Use the method of steps to compute the solution to the initial value problem given in (0.1) on the interval  $0 \leq t \leq 15$  for  $t_0 = 3$ .

### Extrapolation

When precise information about the *form* of the error in an approximation is known, a technique called **extrapolation** can be used to improve the rate of convergence.

Suppose the approximation method converges with rate  $O(h^p)$  as  $h \rightarrow 0$  (cf. Section 3.6).

From theoretical considerations, assume we know, more precisely, that

$$y(x; h) = \phi(x) + h^p a_p(x) + O(h^{p+1}), \quad (0.3)$$

where  $y(x; h)$  is the approximation to  $\phi(x)$  using step size  $h$  and  $a_p(x)$  is some function that is independent of  $h$  (typically, we do not know a formula for  $a_p(x)$ , only that it exists). Our goal is to obtain approximations that converge at the faster rate  $O(h^{p+1})$ .

We start by replacing  $h$  by  $h/2$  in (0.3) to get

$$y\left(x; \frac{h}{2}\right) = \phi(x) + \frac{h^p}{2^p} a_p(x) + O(h^{p+1}).$$

If we multiply both sides by  $2^p$  and subtract equation (0.3), we find

$$2^p y\left(x; \frac{h}{2}\right) - y(x; h) = (2^p - 1) \phi(x) + O(h^{p+1}).$$

Solving for  $\phi(x)$  yields

$$\phi(x) = \frac{2^p y(x; h/2) - y(x; h)}{2^p - 1} + O(h^{p+1}).$$

Hence,

$$y^*\left(x; \frac{h}{2}\right) := \frac{2^p y(x; h/2) - y(x; h)}{2^p - 1}$$

has a rate of convergence of  $O(h^{p+1})$ .



(a) Assuming

$$y^* \left( x; \frac{h}{2} \right) = \phi(x) + h^{p+1} a_{p+1}(x) + O(h^{p+2}),$$

show that

$$y^{**} \left( x; \frac{h}{4} \right) := \frac{2^{p+1} y^* \left( x; \frac{h}{4} \right) - y^* \left( x; \frac{h}{2} \right)}{2^{p+1} - 1}$$

has a rate of convergence of  $O(h^{p+2})$ .

(b) Assuming

$$y^{**} \left( x; \frac{h}{4} \right) = \phi(x) + h^{p+2} a_{p+2}(x) + O(h^{p+3}),$$

show that

$$y^{***} \left( x; \frac{h}{8} \right) := \frac{2^{p+2} y^{**} \left( x; \frac{h}{8} \right) - y^{**} \left( x; \frac{h}{4} \right)}{2^{p+2} - 1}$$

has a rate of convergence of  $O(h^{p+3})$ .

(c) The results of using Euler's method (with  $h = 1, 1/2, 1/4, 1/8$ ) to approximate the solution to the initial value problem

$$y' = y, \quad y(0) = 1$$

at  $x = 1$  are given in Table 1.2, page 27. For Euler's method, the extrapolation procedure applies with  $p = 1$ . Use the results in Table 1.2 to find an approximation to  $e = y(1)$  by computing  $y^{***}(1; 1/8)$ . [Hint: Compute  $y^*(1; 1/2)$ ,  $y^*(1; 1/4)$ , and  $y^*(1; 1/8)$ ; then compute  $y^{**}(1; 1/4)$  and  $y^{**}(1; 1/8)$ .]

(d) Table 1.2 also contains Euler's approximation for  $y(1)$  when  $h = 1/16$ . Use this additional information to compute the next step in the extrapolation procedure; that is, compute  $y^{****}(1; 1/16)$ .

## Group Projects for Chapter 5

### Effects of Hunting on Predator–Prey Systems

As discussed in Section 5.3 (page 277), cyclic variations in the population of predators and their prey have been studied using the Volterra-Lotka predator–prey model

$$\frac{dx}{dt} = Ax - Bxy, \tag{0.4}$$

$$\frac{dy}{dt} = -Cy + Dxy, \tag{0.5}$$

where  $A$ ,  $B$ ,  $C$ , and  $D$  are positive constants,  $x(t)$  is the population of prey at time  $t$ , and  $y(t)$  is the population of predators. It can be shown that such a system has a periodic solution (see Project D). That is, there exists some constant  $T$  such that  $x(t) = x(t+T)$  and  $y(t) = y(t+T)$  for all  $t$ . The periodic or cyclic variation in the population has been observed in various systems such as sharks–food fish, lynx–rabbits, and ladybird beetles–cottony cushion scale. Because of this periodic behavior, it is useful to consider the average population  $\bar{x}$  and  $\bar{y}$  defined by

$$\bar{x} := \frac{1}{T} \int_0^T x(t) dt, \quad \bar{y} := \frac{1}{T} \int_0^T y(t) dt.$$

- (a) Show that  $\bar{x} = C/D$  and  $\bar{y} = A/B$ . [Hint: Use equation (0.4) and the fact that  $x(0) = x(T)$  to show that

$$\int_0^T [A - By(t)] dt = \int_0^T \frac{x'(t)}{x(t)} dt = 0.]$$

- (b) To determine the effect of indiscriminate hunting on the population, assume hunting reduces the rate of change in a population by a constant times the population. Then the predator–prey system satisfies the new set of equations

$$\frac{dx}{dt} = Ax - Bxy - \varepsilon x = (A - \varepsilon)x - Bxy, \quad (0.6)$$

$$\frac{dy}{dt} = -Cy + Dxy - \delta y = -(C + \delta)y + Dxy, \quad (0.7)$$

where  $\varepsilon$  and  $\delta$  are positive constants with  $\varepsilon < A$ . What effect does this have on the average population of prey? On the average population of predators?

- (c) Assume the hunting was done selectively, as in shooting only rabbits (or shooting only lynx). Then we have  $\varepsilon > 0$  and  $\delta = 0$  (or  $\varepsilon = 0$  and  $\delta > 0$ ) in (0.6)–(0.7). What effect does this have on the average populations of predator and prey?
- (d) In a rural county, foxes prey mainly on rabbits but occasionally include a chicken in their diet. The farmers decide to put a stop to the chicken killing by hunting the foxes. What do you predict will happen? What will happen to the farmers' gardens?

## Limit Cycles

In the study of triode vacuum tubes, one encounters the van der Pol equation<sup>2</sup>

$$y'' - \mu(1 - y^2)y' + y = 0,$$

where the constant  $\mu$  is regarded as a parameter. In Section 4.8 (page 224), we used the mass-spring oscillator analogy to argue that the nonzero solutions to the van der Pol equation with  $\mu = 1$  should approach a periodic limit cycle. The same argument applies for any positive value of  $\mu$ .

- (a) Recast the van der Pol equation as a system in normal form and use software to plot some typical trajectories for  $\mu = 0.1, 1,$  and  $10$ . Re-scale the plots if necessary until you can discern the limit cycle trajectory; find trajectories that spiral in, and ones that spiral out, to the limit cycle.
- (b) Now let  $\mu = -0.1, -1,$  and  $-10$ . Try to predict the nature of the solutions using the mass-spring analogy. Then use the software to check your predictions. Are there limit cycles? Do the neighboring trajectories spiral into, or spiral out from, the limit cycles?
- (c) Repeat parts (a) and (b) for the Rayleigh equation

$$y'' - \mu \left[ 1 - (y')^2 \right] y' + y = 0.$$

## Group Project for Chapter 13

David Stapleton, University of Central Oklahoma

### Satellite Altitude Stability

In this problem, we determine the orientation at which a satellite in a circular orbit of radius  $r$  can maintain a relatively constant facing with respect to a spherical primary (e.g., a planet) of mass  $M$ . The torque of gravity on the asymmetric satellite maintains the orientation.

---

<sup>2</sup>*Historical Footnote:* Experimental research by **E. V. Appleton** and **B. van der Pol** in 1921 on the oscillation of an electrical circuit containing a triode generator (vacuum tube) led to the nonlinear equation now called **van der Pol's equation**. Methods of solution were developed by van der Pol in 1926–1927. **Mary L. Cartwright** continued research into nonlinear oscillation theory and together with **J. E. Littlewood** obtained existence results for forced oscillations in nonlinear systems in 1945.

Suppose  $(x, y, z)$  and  $(\bar{x}, \bar{y}, \bar{z})$  refer to coordinates in two systems that have a common origin at the satellite's center of mass. Fix the  $xyz$ -axes in the satellite as principal axes; then let the  $\bar{z}$ -axis point toward the primary and let the  $\bar{x}$ -axis point in the direction of the satellite's velocity. The  $xyz$ -axes may be rotated to coincide with the  $\bar{x}\bar{y}\bar{z}$ -axes by a rotation  $\phi$  about the  $x$ -axis (roll), followed by a rotation  $\theta$  about the resulting  $y$ -axis (pitch), and a rotation  $\psi$  about the final  $z$ -axis (yaw). Euler's equations from physics (with high terms omitted<sup>3</sup> to obtain approximate solutions valid near  $(\phi, \theta, \psi) = (0, 0, 0)$ ) show that the equations for the rotational motion due to gravity acting on the satellite are

$$\begin{aligned} I_x \phi'' &= -4\omega_0^2 (I_z - I_y) \phi - \omega_0 (I_y - I_z - I_x) \psi' \\ I_y \theta'' &= -3\omega_0^2 (I_x - I_z) \theta \\ I_z \psi'' &= -4\omega_0^2 (I_y - I_x) \psi + \omega_0 (I_y - I_z - I_x) \phi', \end{aligned}$$

where  $\omega_0 = \sqrt{(GM)/r^3}$  is the angular frequency of the orbit and the positive constants  $I_x, I_y, I_z$  are the moments of inertia of the satellite about the  $x, y,$  and  $z$ -axes.

(a) Find constants  $c_1, \dots, c_5$  such that these equations can be written as two systems

$$\frac{d}{dt} \begin{bmatrix} \phi \\ \psi \\ \phi' \\ \theta' \end{bmatrix} = \begin{bmatrix} 0 & 0 & 1 & 0 \\ 0 & 0 & 0 & 1 \\ c_1 & 0 & 0 & c_2 \\ 0 & c_3 & c_4 & 0 \end{bmatrix} \begin{bmatrix} \phi \\ \psi \\ \phi' \\ \psi' \end{bmatrix}$$

and

$$\frac{d}{dt} \begin{bmatrix} \theta \\ \theta' \end{bmatrix} = \begin{bmatrix} 0 & 1 \\ c_5 & 0 \end{bmatrix} \begin{bmatrix} \theta \\ \theta' \end{bmatrix}.$$

(b) Show that the origin is asymptotically stable for the first system in (a) if

$$\begin{aligned} (c_2 c_4 + c_3 + c_1)^2 - 4c_1 c_3 &> 0, \\ c_1 c_3 &> 0, \\ c_2 c_4 + c_3 + c_1 &> 0 \end{aligned}$$

and hence deduce that  $I_y > I_x > I_z$  yields an asymptotically stable origin. Are there other conditions on the moments of inertia by which the origin is stable?

---

<sup>3</sup>The derivation of these equations is found in *Attitude Stabilization and Control of Earth Satellites*, by O. H. Gerlach, Space Science Reviews, #4 (1965), 541–566

- (c) Show that, for the asymptotically stable configuration in (b), the second system in (a) becomes a harmonic oscillator problem, and find the frequency of oscillation in terms of  $I_x$ ,  $I_y$ ,  $I_z$ , and  $\omega_0$ . Phobos maintains  $I_y > I_x > I_z$  in its orientation with respect to Mars, and has angular frequency of orbit  $\omega_0 = 0.82$  rad/hr. If  $(I_x - I_z)/I_y = 0.23$ , show that the period of the libration for Phobos (the period with which the side of Phobos facing Mars shakes back and forth) is about 9 hours.

# CHAPTER 1: Introduction

## EXERCISES 1.1: Background

2. This equation is an ODE because it contains no partial derivatives. Since the highest order derivative is  $d^2y/dx^2$ , the equation is a second order equation. This same term also shows us that the independent variable is  $x$  and the dependent variable is  $y$ . This equation is linear.
4. This equation is a PDE of the second order because it contains second partial derivatives.  $x$  and  $y$  are independent variables, and  $u$  is the dependent variable.
6. This equation is an ODE of the first order with the independent variable  $t$  and the dependent variable  $x$ . It is nonlinear.
8. ODE of the second order with the independent variable  $x$  and the dependent variable  $y$ , nonlinear.
10. ODE of the fourth order with the independent variable  $x$  and the dependent variable  $y$ , linear.
12. ODE of the second order with the independent variable  $x$  and the dependent variable  $y$ , nonlinear.
14. The velocity at time  $t$  is the rate of change of the position function  $x(t)$ , i.e.,  $x'$ . Thus,

$$\frac{dx}{dt} = kx^4,$$

where  $k$  is the proportionality constant.

16. The equation is

$$\frac{dA}{dt} = kA^2,$$

where  $k$  is the proportionality constant.

## Chapter 1

### EXERCISES 1.2: Solutions and Initial Value Problems

2. (a) Writing the given equation in the form  $y^2 = 3 - x$ , we see that it defines two functions of  $x$  on  $x \leq 3$ ,  $y = \pm\sqrt{3 - x}$ . Differentiation yields

$$\begin{aligned}\frac{dy}{dx} &= \frac{d}{dx} (\pm\sqrt{3 - x}) = \pm \frac{d}{dx} [(3 - x)^{1/2}] \\ &= \pm \frac{1}{2}(3 - x)^{-1/2}(-1) = -\frac{1}{\pm 2\sqrt{3 - x}} = -\frac{1}{2y}.\end{aligned}$$

- (b) Solving for  $y$  yields

$$\begin{aligned}y^3(x - x \sin x) &= 1 \quad \Rightarrow \quad y^3 = \frac{1}{x(1 - \sin x)} \\ \Rightarrow \quad y &= \frac{1}{\sqrt[3]{x(1 - \sin x)}} = [x(1 - \sin x)]^{-1/3}.\end{aligned}$$

The domain of this function is  $x \neq 0$  and

$$\sin x \neq 1 \quad \Rightarrow \quad x \neq \frac{\pi}{2} + 2k\pi, \quad k = 0, \pm 1, \pm 2, \dots$$

For  $0 < x < \pi/2$ , one has

$$\begin{aligned}\frac{dy}{dx} &= \frac{d}{dx} \{[x(1 - \sin x)]^{-1/3}\} = -\frac{1}{3}[x(1 - \sin x)]^{-1/3-1} \frac{d}{dx}[x(1 - \sin x)] \\ &= -\frac{1}{3}[x(1 - \sin x)]^{-1}[x(1 - \sin x)]^{-1/3}[(1 - \sin x) + x(-\cos x)] \\ &= \frac{(x \cos x + \sin x - 1)y}{3x(1 - \sin x)}.\end{aligned}$$

We also remark that the given relation is an implicit solution on any interval not containing points  $x = 0, \pi/2 + 2k\pi, k = 0, \pm 1, \pm 2, \dots$

4. Differentiating the function  $x = 2 \cos t - 3 \sin t$  twice, we obtain

$$x' = -2 \sin t - 3 \cos t, \quad x'' = -2 \cos t + 3 \sin t.$$

Thus,

$$x'' + x = (-2 \cos t + 3 \sin t) + (2 \cos t - 3 \sin t) = 0$$

for any  $t$  on  $(-\infty, \infty)$ .

6. Substituting  $x = \cos 2t$  and  $x' = -2 \sin 2t$  into the given equation yields

$$(-2 \sin 2t) + t \cos 2t = \sin 2t \quad \Leftrightarrow \quad t \cos 2t = 3 \sin 2t.$$

Clearly, this is not an identity and, therefore, the function  $x = \cos 2t$  is not a solution.

8. Using the chain rule, we have

$$\begin{aligned}y &= 3 \sin 2x + e^{-x}, \\y' &= 3(\cos 2x)(2x)' + e^{-x}(-x)' = 6 \cos 2x - e^{-x}, \\y'' &= 6(-\sin 2x)(2x)' - e^{-x}(-x)' = -12 \sin 2x + e^{-x}.\end{aligned}$$

Therefore,

$$y'' + 4y = (-12 \sin 2x + e^{-x}) + 4(3 \sin 2x + e^{-x}) = 5e^{-x},$$

which is the right-hand side of the given equation. So,  $y = 3 \sin 2x + e^{-x}$  is a solution.

10. Taking derivatives of both sides of the given relation with respect to  $x$  yields

$$\begin{aligned}\frac{d}{dx}(y - \ln y) &= \frac{d}{dx}(x^2 + 1) \quad \Rightarrow \quad \frac{dy}{dx} - \frac{1}{y} \frac{dy}{dx} = 2x \\ \Rightarrow \quad \frac{dy}{dx} \left(1 - \frac{1}{y}\right) &= 2x \quad \Rightarrow \quad \frac{dy}{dx} \frac{y-1}{y} = 2x \quad \Rightarrow \quad \frac{dy}{dx} = \frac{2xy}{y-1}.\end{aligned}$$

Thus, the relation  $y - \ln y = x^2 + 1$  is an implicit solution to the equation  $y' = 2xy/(y-1)$ .

12. To find  $dy/dx$ , we use implicit differentiation.

$$\begin{aligned}\frac{d}{dx}[x^2 - \sin(x+y)] &= \frac{d}{dx}(1) = 0 \quad \Rightarrow \quad 2x - \cos(x+y) \frac{d}{dx}(x+y) = 0 \\ \Rightarrow \quad 2x - \cos(x+y) \left(1 + \frac{dy}{dx}\right) &= 0 \quad \Rightarrow \quad \frac{dy}{dx} = \frac{2x}{\cos(x+y)} - 1 = 2x \sec(x+y) - 1,\end{aligned}$$

and so the given differential equation is satisfied.

14. Assuming that  $C_1$  and  $C_2$  are constants, we differentiate the function  $\phi(x)$  twice to get

$$\phi'(x) = C_1 \cos x - C_2 \sin x, \quad \phi''(x) = -C_1 \sin x - C_2 \cos x.$$

Therefore,

$$\phi'' + \phi = (-C_1 \sin x - C_2 \cos x) + (C_1 \sin x + C_2 \cos x) = 0.$$

Thus,  $\phi(x)$  is a solution with any choice of constants  $C_1$  and  $C_2$ .

16. Differentiating both sides, we obtain

$$\frac{d}{dx}(x^2 + Cy^2) = \frac{d}{dx}(1) = 0 \quad \Rightarrow \quad 2x + 2Cy \frac{dy}{dx} = 0 \quad \Rightarrow \quad \frac{dy}{dx} = -\frac{x}{Cy}.$$



## Chapter 1

Since, from the given relation,  $Cy^2 = 1 - x^2$ , we have

$$-\frac{x}{Cy} = \frac{xy}{-Cy^2} = \frac{xy}{x^2 - 1}.$$

So,

$$\frac{dy}{dx} = \frac{xy}{x^2 - 1}.$$

Writing  $Cy^2 = 1 - x^2$  in the form

$$x^2 + \frac{y^2}{\left(1/\sqrt{C}\right)^2} = 1,$$

we see that the curves defined by the given relation are ellipses with semi-axes 1 and  $1/\sqrt{C}$  and so the integral curves are half-ellipses located in the upper/lower half plane.

**18.** The function  $\phi(x)$  is defined and differentiable for all values of  $x$  except those satisfying

$$c^2 - x^2 = 0 \quad \Rightarrow \quad x = \pm c.$$

In particular, this function is differentiable on  $(-c, c)$ .

Clearly,  $\phi(x)$  satisfies the initial condition:

$$\phi(0) = \frac{1}{c^2 - 0^2} = \frac{1}{c^2}.$$

Next, for any  $x$  in  $(-c, c)$ ,

$$\frac{d\phi}{dx} = \frac{d}{dx} \left[ (c^2 - x^2)^{-1} \right] = (-1)(c^2 - x^2)^{-2} (c^2 - x^2)' = 2x \left[ (c^2 - x^2)^{-1} \right]^2 = 2x\phi(x)^2.$$

Therefore,  $\phi(x)$  is a solution to the equation  $y' = 2xy^2$  on  $(-c, c)$ .

Several integral curves are shown in Fig. 1-A on page 29.

**20. (a)** Substituting  $\phi(x) = e^{mx}$  into the given equation yields

$$(e^{mx})'' + 6(e^{mx})' + 5(e^{mx}) = 0 \quad \Rightarrow \quad e^{mx}(m^2 + 6m + 5) = 0.$$

Since  $e^{mx} \neq 0$  for any  $x$ ,  $\phi(x)$  satisfies the given equation if and only if

$$m^2 + 6m + 5 = 0 \quad \Leftrightarrow \quad m = -1, -5.$$

(b) We have

$$\begin{aligned} (e^{mx})''' + 3(e^{mx})'' + 2(e^{mx})' = 0 &\Rightarrow e^{mx}(m^3 + 3m^2 + 2m) = 0 \\ \Rightarrow m(m^2 + 3m + 2) = 0 &\Leftrightarrow m = 0, -1, -2. \end{aligned}$$

22. We find

$$\phi'(x) = c_1 e^x - 2c_2 e^{-2x}, \quad \phi''(x) = c_1 e^x + 4c_2 e^{-2x}.$$

Substitution yields

$$\begin{aligned} \phi'' + \phi' - 2\phi &= (c_1 e^x + 4c_2 e^{-2x}) + (c_1 e^x - 2c_2 e^{-2x}) - 2(c_1 e^x + c_2 e^{-2x}) \\ &= (c_1 + c_1 - 2c_1) e^x + (4c_2 - 2c_2 - 2c_2) e^{-2x} = 0. \end{aligned}$$

Thus, with any choice of constants  $c_1$  and  $c_2$ ,  $\phi(x)$  is a solution to the given equation.

(a) Constants  $c_1$  and  $c_2$  must satisfy the system

$$\begin{cases} 2 = \phi(0) = c_1 + c_2 \\ 1 = \phi'(0) = c_1 - 2c_2. \end{cases}$$

Subtracting the second equation from the first one yields

$$3c_2 = 1 \quad \Rightarrow \quad c_2 = 1/3 \quad \Rightarrow \quad c_1 = 2 - c_2 = 5/3.$$

(b) Similarly to the part (a), we obtain the system

$$\begin{cases} 1 = \phi(1) = c_1 e + c_2 e^{-2} \\ 0 = \phi'(1) = c_1 e - 2c_2 e^{-2} \end{cases}$$

which has the solution  $c_1 = (2/3)e^{-1}$ ,  $c_2 = (1/3)e^2$ .

24. In this problem, the independent variable is  $t$ , the dependent variable is  $y$ . Writing the equation in the form

$$\frac{dy}{dt} = ty + \sin^2 t,$$

we conclude that  $f(t, y) = ty + \sin^2 t$ ,  $\partial f(t, y)/\partial y = t$ . Both functions,  $f$  and  $\partial f/\partial y$ , are continuous on the whole  $ty$ -plane. So, Theorem 1 applies for any initial condition, in particular, for  $y(\pi) = 5$ .

## Chapter 1

26. With the independent variable  $t$  and the dependent variable  $x$ , we have

$$f(t, x) = \sin t - \cos x, \quad \frac{\partial f(t, x)}{\partial x} = \sin x,$$

which are continuous on  $tx$ -plane. So, Theorem 1 applies for any initial condition.

28. Here,  $f(x, y) = 3x - \sqrt[3]{y-1}$  and

$$\frac{\partial f(x, y)}{\partial y} = \frac{\partial}{\partial y} [3x - (y-1)^{1/3}] = -\frac{1}{3\sqrt[3]{(y-1)^2}}.$$

The function  $f$  is continuous at any point  $(x, y)$  while  $\partial f/\partial y$  is defined and continuous at any point  $(x, y)$  with  $y \neq 1$  i.e., on the  $xy$ -plane excluding the horizontal line  $y = 1$ . Since the initial point  $(2, 1)$  belongs to this line, there is no rectangle containing the initial point, on which  $\partial f/\partial y$  is continuous. Thus, Theorem 1 does not apply.

30. Here, the initial point  $(x_0, y_0)$  is  $(0, -1)$  and  $G(x, y) = x + y + e^{xy}$ . The first partial derivatives,

$$G_x(x, y) = (x + y + e^{xy})'_x = 1 + ye^{xy} \quad \text{and} \quad G_y(x, y) = (x + y + e^{xy})'_y = 1 + xe^{xy},$$

are continuous on the  $xy$ -plane. Next,

$$G(0, -1) = -1 + e^0 = 0, \quad G_y(0, -1) = 1 + (0)e^0 = 1 \neq 0.$$

Therefore, all the hypotheses of Implicit Function Theorem are satisfied, and so the relation  $x + y + e^{xy} = 0$  defines a differentiable function  $y = \phi(x)$  on some interval  $(-\delta, \delta)$  about  $x_0 = 0$ .

### EXERCISES 1.3: Direction Fields

2. (a) Starting from the initial point  $(0, -2)$  and following the direction markers we get the curve shown in Fig. 1-B on page 30.

Thus, the solution curve to the initial value problem  $dy/dx = 2x + y$ ,  $y(0) = -2$ , is the line with slope

$$\frac{dy}{dx}(0) = (2x + y)|_{x=0} = y(0) = -2$$

and  $y$ -intercept  $y(0) = -2$ . Using the slope-intercept form of an equation of a line, we get  $y = -2x - 2$ .

(b) This time, we start from the point  $(-1, 3)$  and obtain the curve shown in Fig. 1–C on page 30.

(c) From Fig. 1–C, we conclude that

$$\lim_{x \rightarrow \infty} y(x) = \infty, \quad \lim_{x \rightarrow -\infty} y(x) = \infty.$$

4. The direction field and the solution curve satisfying the given initial conditions are sketched in Fig. 1–D on page 30. From this figure we find that the terminal velocity is  $\lim_{t \rightarrow \infty} v(t) = 2$ .

6. (a) The slope of the solution curve to the differential equation  $y' = x + \sin y$  at a point  $(x, y)$  is given by  $y'$ . Therefore the slope at  $(1, \pi/2)$  is equal to

$$\left. \frac{dy}{dx} \right|_{x=1} = (x + \sin y)|_{x=1} = 1 + \sin \frac{\pi}{2} = 2.$$

(b) The solution curve is increasing if the slope of the curve is greater than zero. From the part (a), we know that the slope is  $x + \sin y$ . The function  $\sin y$  has values ranging from  $-1$  to  $1$ ; therefore if  $x$  is greater than  $1$  then the slope will always have a value greater than zero. This tells us that the solution curve is increasing.

(c) The second derivative of every solution can be determined by differentiating both sides of the original equation,  $y' = x + \sin y$ . Thus

$$\begin{aligned} \frac{d}{dx} \left( \frac{dy}{dx} \right) &= \frac{d}{dx} (x + \sin y) \quad \Rightarrow \\ \frac{d^2 y}{dx^2} &= 1 + (\cos y) \frac{dy}{dx} \quad (\text{chain rule}) \\ &= 1 + (\cos y)(x + \sin y) \\ &= 1 + x \cos y + \sin y \cos y = 1 + x \cos y + \frac{1}{2} \sin 2y. \end{aligned}$$

(d) Relative minima occur when the first derivative,  $y'$ , is equal to zero and the second derivative,  $y''$ , is positive (Second Derivative Test). The value of the first derivative at the point  $(0, 0)$  is given by

$$\left. \frac{dy}{dx} \right|_{(0,0)} = 0 + \sin 0 = 0.$$

This tells us that the solution has a critical point at the point  $(0, 0)$ . Using the second derivative found in part (c) we have

$$\left. \frac{d^2 y}{dx^2} \right|_{(0,0)} = 1 + 0 \cdot \cos 0 + \frac{1}{2} \sin 0 = 1.$$

## Chapter 1

This tells us that the point  $(0, 0)$  is a point of relative minimum.

8. (a) For this particle, we have  $x(2) = 1$ , and so the velocity

$$v(2) = \left. \frac{dx}{dt} \right|_{t=2} = t^3 - x^3 \Big|_{t=2} = 2^3 - x(2)^3 = 7.$$

- (b) Differentiating the given equation yields

$$\begin{aligned} \frac{d^2x}{dt^2} &= \frac{d}{dt} \left( \frac{dx}{dt} \right) = \frac{d}{dt} (t^3 - x^3) = 3t^2 - 3x^2 \frac{dx}{dt} \\ &= 3t^2 - 3x^2 (t^3 - x^3) = 3t^2 - 3t^3x^2 + 3x^5. \end{aligned}$$

- (c) The function  $u^3$  is an increasing function. Therefore, as long as  $x(t) < t$ ,  $x(t)^3 < t^3$  and

$$\frac{dx}{dt} = t^3 - x(t)^3 > 0$$

meaning that  $x(t)$  increases. At the initial point  $t_0 = 2.5$  we have  $x(t_0) = 2 < t_0$ .

Therefore,  $x(t)$  cannot take values smaller than 2.5, and the answer is “no”.

10. Direction fields and some solution curves to differential equations given in (a)–(e) are shown in Fig. 1–E through Fig. 1–I on pages 31–32.

(a)  $y' = \sin x$ .

(b)  $y' = \sin y$ .

(c)  $y' = \sin x \sin y$ .

(d)  $y' = x^2 + 2y^2$ .

(e)  $y' = x^2 - 2y^2$ .

12. The isoclines satisfy the equation  $f(x, y) = y = c$ , i.e., they are horizontal lines shown in Fig. 1–J, page 32, along with solution curves. The curve, satisfying the initial condition, is shown in bold.

14. Here,  $f(x, y) = x/y$ , and so the isoclines are defined by

$$\frac{x}{y} = c \quad \Rightarrow \quad y = \frac{1}{c}x.$$

These are lines passing through the origin and having slope  $1/c$ . See Fig. 1–K on page 33.

16. The relation  $x + 2y = c$  yields  $y = (c - x)/2$ . Therefore, the isoclines are lines with slope  $-1/2$  and  $y$ -intercept  $c/2$ . See Fig. 1–L on page 33.
18. The direction field for this equation is shown in Fig. 1–M on page 33. From this picture we conclude that any solution  $y(x)$  approaches zero, as  $x \rightarrow +\infty$ .

### EXERCISES 1.4: The Approximation Method of Euler

2. In this problem,  $x_0 = 0$ ,  $y_0 = 4$ ,  $h = 0.1$ , and  $f(x, y) = -x/y$ . Thus, the recursive formulas given in equations (2) and (3) of the text become

$$\begin{aligned}x_{n+1} &= x_n + h = x_n + 0.1, \\y_{n+1} &= y_n + hf(x_n, y_n) = y_n + 0.1 \left( -\frac{x_n}{y_n} \right), \quad n = 0, 1, 2, \dots\end{aligned}$$

To find an approximation for the solution at the point  $x_1 = x_0 + 0.1 = 0.1$ , we let  $n = 0$  in the last recursive formula to find

$$y_1 = y_0 + 0.1 \left( -\frac{x_0}{y_0} \right) = 4 + 0.1(0) = 4.$$

To approximate the value of the solution at the point  $x_2 = x_1 + 0.1 = 0.2$ , we let  $n = 1$  in the last recursive formula to obtain

$$y_2 = y_1 + 0.1 \left( -\frac{x_1}{y_1} \right) = 4 + 0.1 \left( -\frac{0.1}{4} \right) = 4 - \frac{1}{400} = 3.9975 \approx 3.998.$$

Continuing in this way we find

$$\begin{aligned}x_3 &= x_2 + 0.1 = 0.3, & y_3 &= y_2 + 0.1 \left( -\frac{x_2}{y_2} \right) = 3.9975 + 0.1 \left( -\frac{0.2}{3.9975} \right) \approx 3.992, \\x_4 &= 0.4, & y_4 &\approx 3.985, \\x_5 &= 0.5, & y_5 &\approx 3.975,\end{aligned}$$

where all of the answers have been rounded off to three decimal places.

4. Here  $x_0 = 0$ ,  $y_0 = 1$ , and  $f(x, y) = x + y$ . So,

$$\begin{aligned}x_{n+1} &= x_n + h = x_n + 0.1, \\y_{n+1} &= y_n + hf(x_n, y_n) = y_n + 0.1(x_n + y_n), \quad n = 0, 1, 2, \dots\end{aligned}$$

Letting  $n = 0, 1, 2, 3$ , and 4, we recursively find

$$x_1 = x_0 + h = 0.1, \quad y_1 = y_0 + 0.1(x_0 + y_0) = 1 + 0.1(0 + 1) = 1.1,$$

## Chapter 1

$$\begin{aligned}x_2 &= x_1 + h = 0.2, & y_2 &= y_1 + 0.1(x_1 + y_1) = 1.1 + 0.1(0.1 + 1.1) = 1.22, \\x_3 &= x_2 + h = 0.3, & y_3 &= y_2 + 0.1(x_2 + y_2) = 1.22 + 0.1(0.2 + 1.22) = 1.362, \\x_4 &= x_3 + h = 0.4, & y_4 &= y_3 + 0.1(x_3 + y_3) = 1.362 + 0.1(0.3 + 1.362) = 1.528, \\x_5 &= x_4 + h = 0.5, & y_5 &= y_4 + 0.1(x_4 + y_4) = 1.5282 + 0.1(0.4 + 1.5282) = 1.721,\end{aligned}$$

where all of the answers have been rounded off to three decimal places.

6. In this problem,  $x_0 = 1$ ,  $y_0 = 0$ , and  $f(x, y) = x - y^2$ . So, we let  $n = 0, 1, 2, 3$ , and 4, in the recursive formulas and find

$$\begin{aligned}x_1 &= x_0 + h = 1.1, & y_1 &= y_0 + 0.1(x_0 - y_0^2) = 0 + 0.1(1 - 0^2) = 0.1, \\x_2 &= x_1 + h = 1.2, & y_2 &= y_1 + 0.1(x_1 - y_1^2) = 0.1 + 0.1(1.1 - 0.1^2) = 0.209, \\x_3 &= x_2 + h = 1.3, & y_3 &= y_2 + 0.1(x_2 - y_2^2) = 0.209 + 0.1(1.2 - 0.209^2) = 0.325, \\x_4 &= x_3 + h = 1.4, & y_4 &= y_3 + 0.1(x_3 - y_3^2) = 0.325 + 0.1(1.3 - 0.325^2) = 0.444, \\x_5 &= x_4 + h = 1.5, & y_5 &= y_4 + 0.1(x_4 - y_4^2) = 0.444 + 0.1(1.4 - 0.444^2) = 0.564,\end{aligned}$$

where all of the answers have been rounded off to three decimal places.

8. The initial values are  $x_0 = y_0 = 0$ ,  $f(x, y) = 1 - \sin y$ . If number of steps is  $N$ , then the step  $h = (\pi - x_0)/N = \pi/N$ .

For  $N = 1$ ,  $h = \pi$ ,

$$x_1 = x_0 + h = \pi, \quad y_1 = y_0 + h(1 - \sin y_0) = \pi \approx 3.1416.$$

For  $N = 2$ ,  $h = \pi/2$ ,

$$\begin{aligned}x_1 &= x_0 + \pi/2 = \pi/2, & y_1 &= y_0 + h(1 - \sin y_0) = \pi/2 \approx 1.571, \\x_2 &= x_1 + \pi/2 = \pi, & y_2 &= y_1 + h(1 - \sin y_1) = \pi/2 \approx 1.571.\end{aligned}$$

We continue with  $N = 4$  and 8, and fill in Table 1 on page 28, where the approximations to  $\phi(\pi)$  are rounded to three decimal places.

10. We have  $x_0 = y(0) = 0$ ,  $h = 0.1$ . With this step size, we need  $(1 - 0)/0.1 = 10$  steps to approximate the solution on  $[0, 1]$ . The results of computation are given in Table 1 on page 28.

Next we check that  $y = e^{-x} + x - 1$  is the actual solution to the given initial value problem.

$$\begin{aligned}y' &= (e^{-x} + x - 1)' = -e^{-x} + 1 = x - (e^{-x} + x - 1) = x - y, \\y(0) &= (e^{-x} + x - 1)|_{x=0} = e^0 + 0 - 1 = 0.\end{aligned}$$

Thus, it is the solution.

The solution curve  $y = e^{-x} + x - 1$  and the polygonal line approximation using data from Table 1 are shown in Fig. 1–N, page 34.

- 12.** Here,  $x_0 = 0$ ,  $y_0 = 1$ ,  $f(x, y) = y$ . With  $h = 1/n$ , the recursive formula (3) of the text yields

$$\begin{aligned}y(1) = y_n = y_{n-1} + \frac{y_{n-1}}{n} &= y_{n-1} \left(1 + \frac{1}{n}\right) = \left[ y_{n-2} \left(1 + \frac{1}{n}\right) \right] \left(1 + \frac{1}{n}\right) \\ &= y_{n-2} \left(1 + \frac{1}{n}\right)^2 = \dots = y_0 \left(1 + \frac{1}{n}\right)^n = \left(1 + \frac{1}{n}\right)^n.\end{aligned}$$

- 14.** Computation results are given in Table 1 on page 29.

- 16.** For this problem notice that the independent variable is  $t$  and the dependent variable is  $T$ . Hence, in the recursive formulas for Euler's method,  $t$  will take the place of  $x$  and  $T$  will take the place of  $y$ . Also we see that  $h = 0.1$  and  $f(t, T) = K(M^4 - T^4)$ , where  $K = 40^{-4}$  and  $M = 70$ . Therefore, the recursive formulas given in equations (2) and (3) of the text become

$$\begin{aligned}t_{n+1} &= t_n + 0.1, \\T_{n+1} &= T_n + hf(t_n, T_n) = T_n + 0.1(40^{-4})(70^4 - T_n^4), \quad n = 0, 1, 2, \dots\end{aligned}$$

From the initial condition  $T(0) = 100$  we see that  $t_0 = 0$  and  $T_0 = 100$ . Therefore, for  $n = 0$ , we have

$$\begin{aligned}t_1 &= t_0 + 0.1 = 0 + 0.1 = 0.1, \\T_1 &= T_0 + 0.1(40^{-4})(70^4 - T_0^4) = 100 + 0.1(40^{-4})(70^4 - 100^4) \approx 97.0316,\end{aligned}$$

where we have rounded off to four decimal places.

For  $n = 1$ ,

$$t_2 = t_1 + 0.1 = 0.1 + 0.1 = 0.2,$$



## Chapter 1

$$T_2 = T_1 + 0.1(40^{-4})(70^4 - T_1^4) = 97.0316 + 0.1(40^{-4})(70^4 - 97.0316^4) \approx 94.5068.$$

By continuing this way, we fill in Table 1 on page 29. From this table we see that

$$T(1) = T(t_{10}) \approx T_{10} = 82.694,$$

$$T(2) = T(t_{20}) \approx T_{20} = 76.446,$$

where we have rounded to three decimal places.

### TABLES

$N$	$h$	$\phi(\pi)$
1	$\pi$	3.142
2	$\pi/2$	1.571
4	$\pi/4$	1.207
8	$\pi/8$	1.148

**Table 1–A:** Euler’s approximations to  $y' = 1 - \sin y$ ,  $y(0) = 0$ , with  $N$  steps.

---

$n$	$x_n$	$y_n$	$n$	$x_n$	$y_n$
0	0	0	6	0.6	0.131
1	0.1	0	7	0.7	0.178
2	0.2	0.01	8	0.8	0.230
3	0.3	0.029	9	0.9	0.287
4	0.4	0.056	10	1.0	0.349
5	0.5	0.091			

**Table 1–B:** Euler’s approximations to  $y' = x - y$ ,  $y(0) = 0$ , on  $[0, 1]$  with  $h = 0.1$ .

---

$h$	$y(2)$
0.5	24.8438
0.1	$\approx 6.4 \cdot 10^{176}$
0.05	$\approx 1.9 \cdot 10^{114571}$
0.01	$> 10^{10^{30}}$

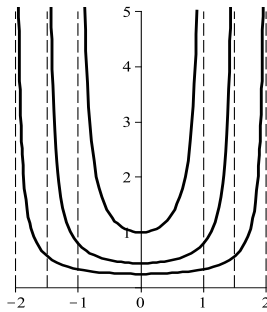
**Table 1–C:** Euler’s method approximations of  $y(2)$  for  $y' = 2xy^2$ ,  $y(0) = 1$ .

---

$n$	$t_n$	$T_n$	$n$	$t_n$	$T_n$
1	0.1	97.0316	11	1.1	81.8049
2	0.2	94.5068	12	1.2	80.9934
3	0.3	92.3286	13	1.3	80.2504
4	0.4	90.4279	14	1.4	79.5681
5	0.5	88.7538	15	1.5	78.9403
6	0.6	87.2678	16	1.6	78.3613
7	0.7	85.9402	17	1.7	77.8263
8	0.8	84.7472	18	1.8	77.3311
9	0.9	83.6702	19	1.9	76.8721
10	1.0	82.6936	20	2.0	76.4459

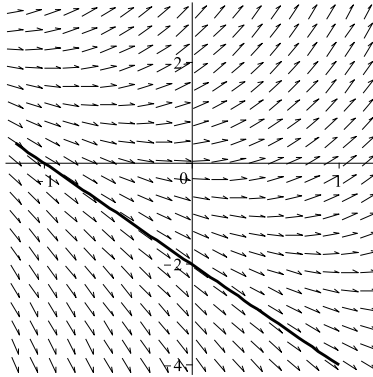
**Table 1–D:** Euler’s approximations to the solution of  $T' = K (M^4 - T^4)$ ,  $T(0) = 100$ , with  $K = 40^{-4}$ ,  $M = 70$ , and  $h = 0.1$ .

**FIGURES**



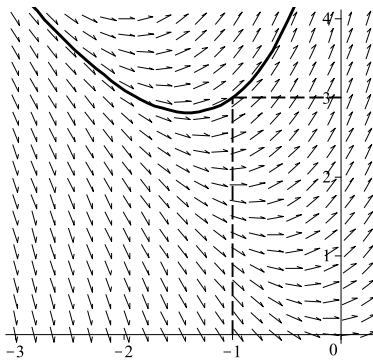
**Figure 1–A:** Integral curves in Problem 18.

# Chapter 1



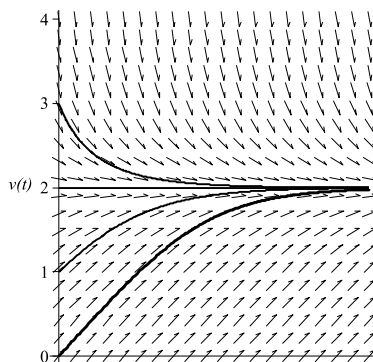
**Figure 1–B:** The solution curve in Problem 2(a).

---



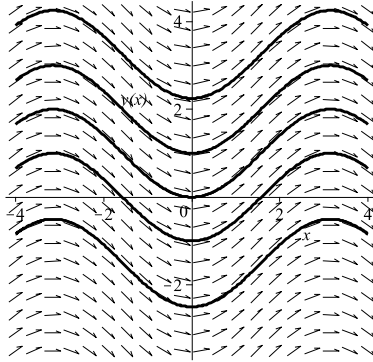
**Figure 1–C:** The solution curve in Problem 2(b).

---



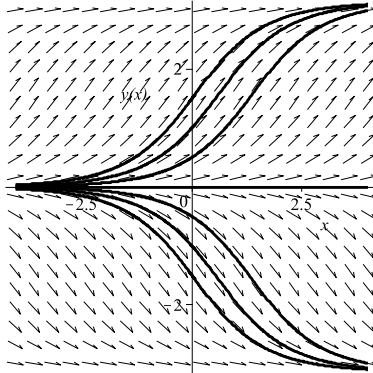
**Figure 1–D:** The direction field and solution curves in Problem 4.

---



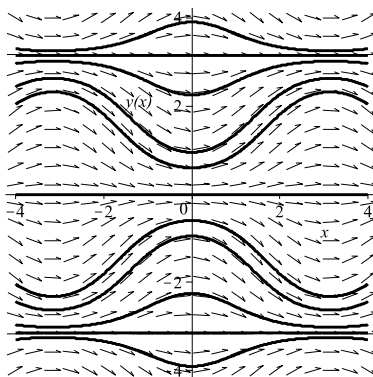
**Figure 1–E:** The direction field and solution curves in Problem 10(a).

---



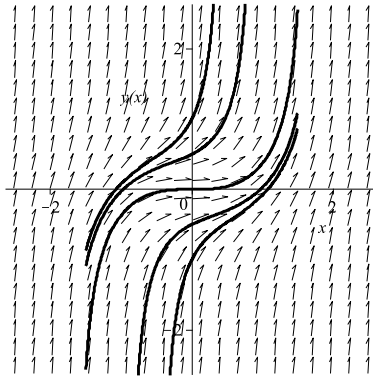
**Figure 1–F:** The direction field and solution curves in Problem 10(b).

---



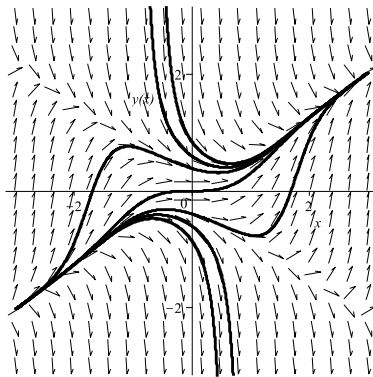
**Figure 1–G:** The direction field and solution curves in Problem 10(c).

---



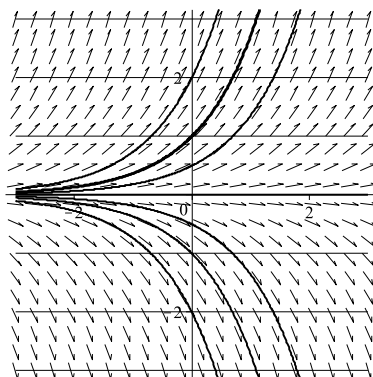
**Figure 1–H:** The direction field and solution curves in Problem 10(d).

---



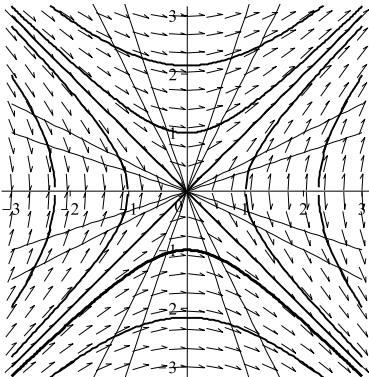
**Figure 1–I:** The direction field and solution curves in Problem 10(e).

---



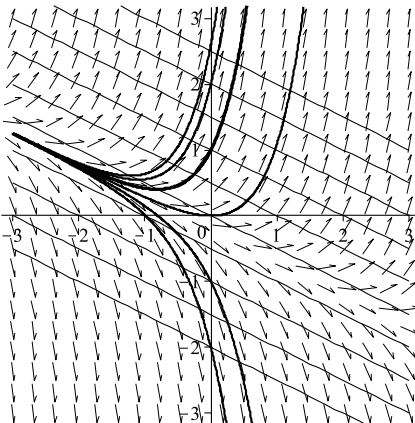
**Figure 1–J:** The isoclines and solution curves in Problem 12.

---



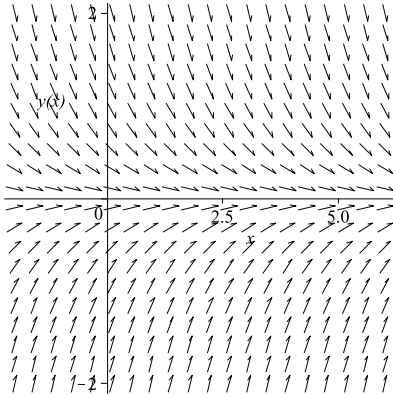
**Figure 1-K:** The isoclines and solution curves in Problem 14.

---



**Figure 1-L:** The isoclines and solution curves in Problem 16.

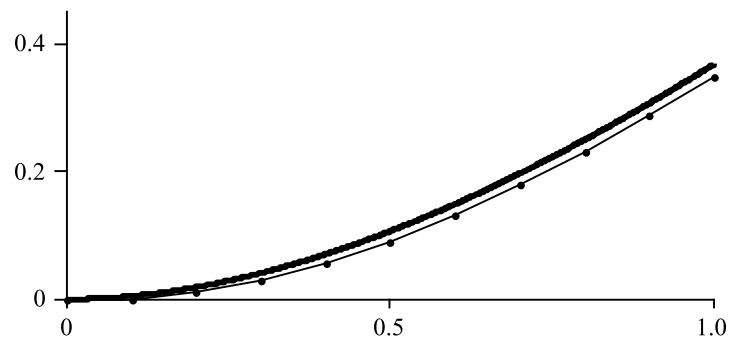
---



**Figure 1-M:** The direction field in Problem 18.

---

## Chapter 1



**Figure 1–N:** Euler's method approximations to  $y = e^{-x} + x - 1$  on  $[0, 1]$  with  $h = 0.1$ .

---

## CHAPTER 2: First Order Differential Equations

### EXERCISES 2.2: Separable Equations

2. This equation is not separable because  $\sin(x + y)$  cannot be expressed as a product  $g(x)p(y)$ .

4. This equation is separable because

$$\frac{ds}{dt} = t \ln(s^{2t}) + 8t^2 = t(2t) \ln |s| + 8t^2 = 2t^2(\ln |s| + 4).$$

6. Writing the equation in the form

$$\frac{dy}{dx} = \frac{2x}{xy^2 + 3y^2} = \frac{2x}{(x+3)y^2} = \frac{2x}{x+3} \cdot \frac{1}{y^2},$$

we see that the equation is separable.

8. Multiplying both sides of the equation by  $y^3 dx$  and integrating yields

$$\begin{aligned} y^3 dy = \frac{dx}{x} &\quad \Rightarrow \quad \int y^3 dy = \int \frac{dx}{x} \\ \Rightarrow \frac{1}{4} y^4 = x \ln |x| + C_1 &\quad \Rightarrow \quad y^4 = 4 \ln |x| + C \quad \Rightarrow \quad y = \pm \sqrt[4]{4 \ln |x| + C}, \end{aligned}$$

where  $C := 4C_1$  is an arbitrary constant.

10. To separate variables, we divide the equation by  $x$  and multiply by  $dt$ . Integrating yields

$$\begin{aligned} \frac{dx}{x} = 3t^2 dt &\quad \Rightarrow \quad \ln |x| = t^3 + C_1 \quad \Rightarrow \quad |x| = e^{t^3 + C_1} = e^{C_1} e^{t^3} \\ \Rightarrow |x| = C_2 e^{t^3} &\quad \Rightarrow \quad x = \pm C_2 e^{t^3} = C e^{t^3}, \end{aligned}$$

where  $C_1$  is an arbitrary constant and, therefore,  $C_2 := e^{C_1}$  is an arbitrary *positive* constant,  $C = \pm C_2$  is any *nonzero* constant. Separating variables, we lost a solution  $x \equiv 0$ , which can be included in the above formula by taking  $C = 0$ . Thus,  $x = C e^{t^3}$ ,  $C$  – arbitrary constant, is a general solution.



## Chapter 2

12. We have

$$\begin{aligned}\frac{3v dv}{1-4v^2} &= \frac{dx}{x} &\Rightarrow &\int \frac{3v dv}{1-4v^2} = \int \frac{dx}{x} \\ \Rightarrow &-\frac{3}{8} \int \frac{du}{u} = \int \frac{dx}{x} &&(u = 1-4v^2, du = -8v dv) \\ \Rightarrow &-\frac{3}{8} \ln |1-4v^2| = \ln |x| + C_1 \\ \Rightarrow &1-4v^2 = \pm \exp \left[ -\frac{8}{3} \ln |x| + C_1 \right] = Cx^{-8/3},\end{aligned}$$

where  $C = \pm e^{C_1}$  is any nonzero constant. Separating variables, we lost constant solutions satisfying

$$1-4v^2 = 0 \quad \Rightarrow \quad v = \pm \frac{1}{2},$$

which can be included in the above formula by letting  $C = 0$ . Thus,

$$v = \pm \frac{\sqrt{1-Cx^{-8/3}}}{2}, \quad C \text{ arbitrary,}$$

is a general solution to the given equation.

14. Separating variables, we get

$$\begin{aligned}\frac{dy}{1+y^2} &= 3x^2 dx &\Rightarrow &\int \frac{dy}{1+y^2} = \int 3x^2 dx \\ \Rightarrow &\arctan y = x^3 + C &\Rightarrow &y = \tan(x^3 + C),\end{aligned}$$

where  $C$  is any constant. Since  $1+y^2 \neq 0$ , we did not lose any solution.

16. We rewrite the equation in the form

$$x(1+y^2)dx + e^{x^2}ydy = 0,$$

separate variables, and integrate.

$$\begin{aligned}e^{-x^2}x dx &= -\frac{y dy}{1+y^2} &\Rightarrow &\int e^{-x^2}x dx = -\int \frac{y dy}{1+y^2} \\ \Rightarrow &\int e^{-u} du = -\frac{dv}{v} &&(u = x^2, v = 1+y^2) \\ \Rightarrow &-e^{-u} = -\ln |v| + C &\Rightarrow &\ln(1+y^2) - e^{-x^2} = C\end{aligned}$$

is an implicit solution to the given equation. Solving for  $y$  yields

$$y = \pm \sqrt{C_1 \exp[\exp(-x^2)] - 1},$$

where  $C_1 = e^C$  is any positive constant,

18. Separating variables yields

$$\frac{dy}{1+y^2} = \tan x dx \Rightarrow \int \frac{dy}{1+y^2} = \int \tan x dx \Rightarrow \arctan y = -\ln |\cos x| + C.$$

Since  $y(0) = \sqrt{3}$ , we have

$$\arctan \sqrt{3} = -\ln \cos 0 + C = C \Rightarrow C = \frac{\pi}{3}.$$

Therefore,

$$\arctan y = -\ln |\cos x| + \frac{\pi}{3} \Rightarrow y = \tan \left( -\ln |\cos x| + \frac{\pi}{3} \right)$$

is the solution to the given initial value problem.

20. Separating variables and integrating, we get

$$\int (2y+1)dy = \int (3x^2+4x+2) dx \Rightarrow y^2 + y = x^3 + 2x^2 + 2x + C.$$

Since  $y(0) = -1$ , substitution yields

$$(-1)^2 + (-1) = (0)^3 + 2(0)^2 + 2(0) + C \Rightarrow C = 0,$$

and the solution is given, implicitly, by  $y^2 + y = x^3 + 2x^2 + 2x$  or, explicitly, by

$$y = -\frac{1}{2} - \sqrt{\frac{1}{4} + x^3 + 2x^2 + 2x}.$$

(Solving for  $y$ , we used the initial condition.)

22. Writing  $2ydy = -x^2dx$  and integrating, we find

$$y^2 = -\frac{x^3}{3} + C.$$

With  $y(0) = 2$ ,

$$(2)^2 = -\frac{(0)^3}{3} + C \Rightarrow C = 4,$$

and so

$$y^2 = -\frac{x^3}{3} + 4 \Rightarrow y = \sqrt{-\frac{x^3}{3} + 4}.$$

We note that, taking the square root, we chose the positive sign because  $y(0) > 0$ .

## Chapter 2

24. For a general solution, we separate variables and integrate.

$$\int e^{2y} dy = \int 8x^3 dx \quad \Rightarrow \quad \frac{e^{2y}}{2} = 2x^4 + C_1 \quad \Rightarrow \quad e^{2y} = 4x^4 + C.$$

We substitute now the initial condition,  $y(1) = 0$ , and obtain

$$1 = 4 + C \quad \Rightarrow \quad C = -3.$$

Hence, the answer is given by

$$e^{2y} = 4x^4 - 3 \quad \Rightarrow \quad y = \frac{1}{2} \ln(4x^4 - 3).$$

26. We separate variables and obtain

$$\int \frac{dy}{\sqrt{y}} = - \int \frac{dx}{1+x} \quad \Rightarrow \quad 2\sqrt{y} = -\ln|1+x| + C = -\ln(1+x) + C,$$

because at initial point,  $x = 0$ ,  $1+x > 0$ . Using the fact that  $y(0) = 1$ , we find  $C$ .

$$2 = 0 + C \quad \Rightarrow \quad C = 2,$$

and so  $y = [2 - \ln(1+x)]^2 / 4$  is the answer.

28. We have

$$\begin{aligned} \frac{dy}{dt} = 2y(1-t) &\quad \Rightarrow \quad \frac{dy}{y} = 2(1-t)dt &\quad \Rightarrow \quad \ln|y| = -(t-1)^2 + C \\ \Rightarrow y = \pm e^C e^{-(t-1)^2} &= C_1 e^{-(t-1)^2}, \end{aligned}$$

where  $C_1 \neq 0$  is any constant. Separating variables, we lost the solution  $y \equiv 0$ . So, a general solution to the given equation is

$$y = C_2 e^{-(t-1)^2}, \quad C_2 \text{ is any.}$$

Substituting  $t = 0$  and  $y = 3$ , we find

$$3 = C_2 e^{-1} \quad \Rightarrow \quad C_2 = 3e \quad \Rightarrow \quad y = 3e^{1-(t-1)^2} = 3e^{2t-t^2}.$$

The graph of this function is given in Fig. **2–A** on page 71.

Since  $y(t) > 0$  for any  $t$ , from the given equation we have  $y'(t) > 0$  for  $t < 1$  and  $y'(t) < 0$  for  $t > 1$ . Thus  $t = 1$  is the point of absolute maximum with  $y_{\max} = y(1) = 3e$ .

30. (a) Dividing by  $(y + 1)^{2/3}$ , multiplying by  $dx$ , and integrating, we obtain

$$\int \frac{dy}{(y + 1)^{2/3}} = \int (x - 3)dx \quad \Rightarrow \quad 3(y + 1)^{1/3} = \frac{x^2}{2} - 3x + C$$

$$\Rightarrow \quad y = -1 + \left( \frac{x^2}{6} - x + C_1 \right)^3.$$

(b) Substituting  $y \equiv -1$  into the original equation yields

$$\frac{d(-1)}{dx} = (x - 3)(-1 + 1)^{2/3} = 0,$$

and so the equation is satisfied.

(c) For  $y \equiv -1$  for the solution in part (a), we must have

$$\left( \frac{x^2}{6} - x + C_1 \right)^3 \equiv 0 \quad \Leftrightarrow \quad \frac{x^2}{6} - x + C_1 \equiv 0,$$

which is impossible since a quadratic polynomial has at most two zeros.

32. (a) The direction field of the given differential equation is shown in Fig. 2–B, page 72. Using this picture we predict that  $\lim_{x \rightarrow \infty} \phi(x) = 1$ .

(b) In notation of Section 1.4, we have  $x_0 = 0$ ,  $y_0 = 1.5$ ,  $f(x, y) = y^2 - 3y + 2$ , and  $h = 0.1$ . With this step size, we need  $(1 - 0)/0.1 = 10$  steps to approximate  $\phi(1)$ . The results of computation are given in Table 2 on page 71. From this table we conclude that  $\phi(1) \approx 1.26660$ .

(c) Separating variables and integrating, we obtain

$$\frac{dy}{y^2 - 3y + 2} = dx \quad \Rightarrow \quad \int \frac{dy}{y^2 - 3y + 2} = \int dx \quad \Rightarrow \quad \ln \left| \frac{y - 2}{y - 1} \right| = x + C,$$

where we have used a partial fractions decomposition

$$\frac{1}{y^2 - 3y + 2} = \frac{1}{y - 2} - \frac{1}{y - 1}$$

to evaluate the integral. The initial condition,  $y(0) = 1.5$ , implies that  $C = 0$ , and so

$$\ln \left| \frac{y - 2}{y - 1} \right| = x \quad \Rightarrow \quad \left| \frac{y - 2}{y - 1} \right| = e^x \quad \Rightarrow \quad \frac{y - 2}{y - 1} = -e^x.$$

(We have chosen the negative sign because of the initial condition.) Solving for  $y$  yields

$$y = \phi(x) = \frac{e^x + 2}{e^x + 1}$$

The graph of this solution is shown in Fig. 2–B on page 72.

## Chapter 2

(d) We find

$$\phi(1) = \frac{e+2}{e+1} \approx 1.26894.$$

Thus, the approximate value  $\phi(1) \approx 1.26660$  found in part (b) differs from the actual value by less than 0.003.

(e) We find the limit of  $\phi(x)$  at infinity writing

$$\lim_{x \rightarrow \infty} \frac{e^x + 2}{e^x + 1} = \lim_{x \rightarrow \infty} \left( 1 + \frac{1}{e^x + 1} \right) = 1,$$

which confirms our guess in part (a).

34. (a) Separating variables and integrating, we get

$$\begin{aligned} \frac{dT}{T-M} = -kdt &\Rightarrow \int \frac{dT}{T-M} = - \int kdt \Rightarrow \ln |T-M| = -kt + C_1 \\ \Rightarrow |T-M| = e^{C_1} e^{-kt} &\Rightarrow T-M = \pm e^{C_1} e^{-kt} = C e^{-kt}, \end{aligned}$$

where  $C$  is any nonzero constant. We can include the lost solution  $T \equiv M$  into this formula by letting  $C = 0$ . Thus, a general solution to the equation is

$$T = M + C e^{-kt}.$$

(b) Given that  $M = 70^\circ$ ,  $T(0) = 100^\circ$ ,  $T(6) = 80^\circ$ , we form a system to determine  $C$  and  $k$ .

$$\begin{cases} 100 = 70 + C \\ 80 = 70 + C e^{-6k} \end{cases} \Rightarrow \begin{cases} C = 30 \\ k = -(1/6) \ln[(80-70)/30] = (1/6) \ln 3. \end{cases}$$

Therefore,

$$T = 70 + 30 e^{-(t \ln 3)/6} = 70 + (30) 3^{-t/6},$$

and after 20 min the reading is

$$T(20) = 70 + (30) 3^{-20/6} \approx 70.77^\circ.$$

36. A general solution to the cooling equation found in Problem 34, that is,  $T = M + C e^{-kt}$ . Since  $T(0) = 100^\circ$ ,  $T(5) = 80^\circ$ , and  $T(10) = 65^\circ$ , we determine  $M$ ,  $C$ , and  $k$  from the system

$$\begin{cases} M + C &= 100 \\ M + C e^{-5k} &= 80 \\ M + C e^{-10k} &= 65 \end{cases} \Rightarrow \begin{cases} C(1 - e^{-5k}) &= 20 \\ C e^{-5k}(1 - e^{-5k}) &= 15 \end{cases} \Rightarrow e^{-5k} = 3/4.$$

To find  $M$ , we can now use the first two equations in the above system.

$$\begin{cases} M + C & = 100 \\ M + (3/4)C & = 80 \end{cases} \Rightarrow M = 20.$$

38. With  $m = 10$ ,  $g = 9.81$ , and  $k = 5$ , the equation becomes

$$100 \frac{dv}{dt} = 100(9.81) - 5v \Rightarrow 20 \frac{dv}{dt} = 196.2 - v.$$

Separating variables and integrating yields

$$\int \frac{dv}{v - 196.2} = -\frac{1}{20} \int dt \Rightarrow \ln |v - 196.2| = -\frac{t}{20} + C_1 \Rightarrow v = 196.2 + Ce^{-t/20},$$

where  $C$  is an arbitrary nonzero constant. With  $C = 0$ , this formula also gives the (lost) constant solution  $v = 196.2$ . From the initial condition,  $v(0) = 10$ , we find  $C$ .

$$196.2 + C = 10 \Rightarrow C = -186.2 \Rightarrow v(t) = 196.2 - 186.2e^{-t/20}.$$

The terminal velocity of the object can be found by letting  $t \rightarrow \infty$ .

$$v_\infty = \lim_{t \rightarrow \infty} (196.2 - 186.2e^{-t/20}) = 196.2 \text{ (m/sec)}.$$

### EXERCISES 2.3: Linear Equations

2. Neither.
4. Linear.
6. Linear.
8. Writing the equation in standard form,

$$\frac{dy}{dx} - \frac{y}{x} = 2x + 1,$$

we see that

$$P(x) = -\frac{1}{x} \Rightarrow \mu(x) = \exp \left[ \int \left( -\frac{1}{x} \right) dx \right] = \exp(-\ln x) = \frac{1}{x}.$$

Multiplying the given equation by  $\mu(x)$ , we get

$$\frac{d}{dx} \left( \frac{y}{x} \right) = 2 + \frac{1}{x} \Rightarrow y = x \int \left( 2 + \frac{1}{x} \right) dx = x(2x + \ln |x| + C).$$

## Chapter 2

10. From the standard form of the given equation,

$$\frac{dy}{dx} + \frac{2}{x}y = x^{-4},$$

we find that

$$\begin{aligned}\mu(x) &= \exp \left[ \int (2/x) dx \right] = \exp(2 \ln x) = x^2 \\ \Rightarrow \frac{d}{dx} (x^2 y) &= x^{-2} \quad \Rightarrow \quad y = x^{-2} \int x^{-2} dx = x^{-2} (-x^{-1} + C) = \frac{Cx - 1}{x^3}.\end{aligned}$$

12. Here,  $P(x) = 4$ ,  $Q(x) = x^2 e^{-4x}$ . So,  $\mu(x) = e^{4x}$  and

$$\frac{d}{dx} (e^{4x} y) = x^2 \quad \Rightarrow \quad y = e^{-4x} \int x^2 dx = e^{-4x} \left( \frac{x^3}{3} + C \right).$$

14. We divide the equation by  $x$  to get to get its standard form.

$$\frac{dy}{dx} + \frac{3}{x}y = x^2 - 2x + 4.$$

Thus,  $P(x) = 3/x$ ,  $Q(x) = x^2 - 2x + 4$ ,

$$\begin{aligned}\mu(x) &= \exp \left( \int \frac{3}{x} dx \right) = x^3 \\ \Rightarrow x^3 y &= \int x^3 (x^2 - 2x + 4) dx = \frac{x^6}{6} - \frac{2x^5}{5} + x^4 + C \\ \Rightarrow y &= \frac{x^3}{6} - \frac{2x^2}{5} + x + Cx^{-3}.\end{aligned}$$

16. We divide by  $x^2 + 1$  both sides of the given equation to get its standard form,

$$\frac{dy}{dx} + \frac{4x}{x^2 + 1}y = \frac{x^2 + 2x - 1}{x^2 + 1}.$$

Thus,  $P(x) = (4x)/(x^2 + 1)$ ,  $Q(x) = (x^2 + 2x - 1)/(x^2 + 1)$ ,

$$\begin{aligned}\mu(x) &= \exp \left( \int \frac{4x}{x^2 + 1} dx \right) = \exp [2 \ln(x^2 + 1)] = (x^2 + 1)^2 \\ \Rightarrow (x^2 + 1)^2 y &= \int (x^2 + 1)(x^2 + 2x - 1) dx = \frac{x^5}{5} + \frac{x^4}{2} + x^2 - x + C \\ \Rightarrow y &= \left( \frac{x^5}{5} + \frac{x^4}{2} + x^2 - x + C \right) (x^2 + 1)^{-2}.\end{aligned}$$

18. Since  $\mu(x) = \exp\left(\int 4dx\right) = e^{4x}$ , we have

$$\begin{aligned}\frac{d}{dx}(e^{4x}y) &= e^{4x}e^{-x} = e^{3x} \\ \Rightarrow y &= e^{-4x} \int e^{3x} dx = \frac{e^{-x}}{3} + Ce^{-4x}.\end{aligned}$$

Substituting the initial condition,  $y = 4/3$  at  $x = 0$ , yields

$$\frac{4}{3} = \frac{1}{3} + C \quad \Rightarrow \quad C = 1,$$

and so  $y = e^{-x}/3 + e^{-4x}$  is the solution to the given initial value problem.

20. We have

$$\begin{aligned}\mu(x) &= \exp\left(\int \frac{3dx}{x}\right) = \exp(3 \ln x) = x^3 \\ \Rightarrow x^3 y &= \int x^3(3x - 2) dx = \frac{3x^5}{5} - \frac{x^4}{2} + C \\ \Rightarrow y &= \frac{3x^2}{5} - \frac{x}{2} + Cx^{-3}.\end{aligned}$$

With  $y(1) = 1$ ,

$$1 = y(1) = \frac{3}{5} - \frac{1}{2} + C \quad \Rightarrow \quad C = \frac{9}{10} \quad \Rightarrow \quad y = \frac{3x^2}{5} - \frac{x}{2} + \frac{9}{10x^3}.$$

22. From the standard form of this equation,

$$\frac{dy}{dx} + y \cot x = x,$$

we find

$$\mu(x) = \exp\left(\int \cot x dx\right) = \exp(\ln \sin x) = \sin x.$$

(Alternatively, one can notice that the left-hand side of the original equation is the derivative of the product  $y \sin x$ .) So, using integration by parts, we obtain

$$\begin{aligned}y \sin x &= \int x \sin x dx = -x \cos x + \sin x + C \\ \Rightarrow y &= -x \cot x + 1 + C \csc x.\end{aligned}$$

We find  $C$  using the initial condition  $y(\pi/2) = 2$ :

$$2 = -\frac{\pi}{2} \cot \frac{\pi}{2} + 1 + C \csc \left(\frac{\pi}{2}\right) = 1 + C \quad \Rightarrow \quad C = 1,$$

and the solution is given by

$$y = -x \cot x + 1 + \csc x.$$



## Chapter 2

**24. (a)** The equation (12) on of the text becomes

$$\begin{aligned}\frac{dy}{dt} + 20y &= 50e^{-10t} &\Rightarrow &\mu(t) = e^{20t} \\ \Rightarrow &y = e^{-20t} \int 50e^{10t} dt = 5e^{-10t} + Ce^{-20t}.\end{aligned}$$

Since  $y(0) = 40$ , we have

$$40 = 5 + C \quad \Rightarrow \quad C = 35 \quad \Rightarrow \quad y = 5e^{-10t} + 35e^{-20t}.$$

The term  $5e^{-10t}$  will eventually dominate.

**(b)** This time, the equation (12) has the form

$$\begin{aligned}\frac{dy}{dt} + 10y &= 50e^{-10t} &\Rightarrow &\mu(t) = e^{10t} \\ \Rightarrow &y = e^{-10t} \int 50 dt = e^{-10t}(50t + C).\end{aligned}$$

Substituting the initial condition yields

$$40 = y(0) = C \quad \Rightarrow \quad y = e^{-10t}(50t + 40).$$

**26.** Here

$$\begin{aligned}P(x) &= \frac{\sin x \cos x}{1 + \sin^2 x} \\ \Rightarrow \mu(x) &= \exp\left(\int \frac{\sin x \cos x dx}{1 + \sin^2 x}\right) = \exp\left[\frac{1}{2} \ln(1 + \sin^2 x)\right] = \sqrt{1 + \sin^2 x}.\end{aligned}$$

Thus,

$$y\sqrt{1 + \sin^2 x} = \int_0^x \sqrt{1 + \sin^2 t} dt \quad \Rightarrow \quad y = (1 + \sin^2 x)^{-1/2} \int_0^x (1 + \sin^2 t)^{1/2} dt$$

and

$$y(1) = (1 + \sin^2 1)^{-1/2} \int_0^1 (1 + \sin^2 t)^{1/2} dt.$$

We now use the Simpson's Rule to find that  $y(1) \approx 0.860$ .

**28. (a)** Substituting  $y = e^{-x}$  into the equation (16) yields

$$\frac{d(e^{-x})}{dx} + e^{-x} = -e^{-x} + e^{-x} = 0.$$

So,  $y = e^{-x}$  is a solution to (16).

The function  $y = x^{-1}$  is a solution to (17) because

$$\frac{d(x^{-1})}{dx} + (x^{-1})^2 = (-1)x^{-2} + x^{-2} = 0.$$

(b) For any constant  $C$ ,

$$\frac{d(Ce^{-x})}{dx} + Ce^{-x} = -Ce^{-x} + Ce^{-x} = 0.$$

Thus  $y = Ce^{-x}$  is a solution to (16).

Substituting  $y = Cx^{-1}$  into (17), we obtain

$$\frac{d(Cx^{-1})}{dx} + (Cx^{-1})^2 = (-C)x^{-2} + C^2x^{-2} = C(C-1)x^{-2},$$

and so we must have  $C(C-1) = 0$  in order that  $y = Cx^{-1}$  is a solution to (17).

Thus, either  $C = 0$  or  $C = 1$ .

(c) For the function  $y = C\hat{y}$ , one has

$$\frac{d(C\hat{y})}{dx} + P(x)(C\hat{y}) = C\frac{d\hat{y}}{dx} + C(P(x)\hat{y}) = C\left(\frac{d\hat{y}}{dx} + P(x)\hat{y}\right) = 0$$

if  $\hat{y}$  is a solution to  $y' + P(x)y = 0$ .

30. (a) Multiplying both sides of (18) by  $y^2$ , we get

$$y^2 \frac{dy}{dx} + 2y^3 = x.$$

If  $v = y^3$ , then  $v' = 3y^2y'$ . Thus,  $y^2y' = v'/3$ , and we have

$$\frac{1}{3} \frac{dv}{dx} + 2v = x,$$

which is equivalent to (19).

(b) The equation (19) is linear with  $P(x) = 6$  and  $Q(x) = 3x$ . So,

$$\begin{aligned} \mu(x) &= \exp\left(\int 6dx\right) = e^{6x} \\ \Rightarrow v(x) &= e^{-6x} \int (3xe^{6x})dx = \frac{e^{-6x}}{2} \left(xe^{6x} - \int e^{6x} dx\right) \\ &= \frac{e^{-6x}}{2} \left(xe^{6x} - \frac{e^{6x}}{6} + C_1\right) = \frac{x}{2} - \frac{1}{12} + Ce^{-6x}, \end{aligned}$$

where  $C = C_1/2$  is an arbitrary constant. The back substitution yields

$$y = \sqrt[3]{\frac{x}{2} - \frac{1}{12} + Ce^{-6x}}.$$

## Chapter 2

- 32.** In the given equation,  $P(x) = 2$ , which implies that  $\mu(x) = e^{2x}$ . Following guidelines, first we solve the equation on  $[0, 3]$ . On this interval,  $Q(x) \equiv 2$ . Therefore,

$$y_1(x) = e^{-2x} \int (2)e^{2x} dx = 1 + C_1 e^{-2x}.$$

Since  $y_1(0) = 0$ , we get

$$1 + C_1 e^0 = 0 \quad \Rightarrow \quad C_1 = -1 \quad \Rightarrow \quad y_1(x) = 1 - e^{-2x}.$$

For  $x > 3$ ,  $Q(x) = -2$  and so

$$y_2(x) = e^{-2x} \int (-2)e^{2x} dx = -1 + C_2 e^{-2x}.$$

We now choose  $C_2$  so that

$$y_2(3) = y_1(3) = 1 - e^{-6} \quad \Rightarrow \quad -1 + C_2 e^{-6} = 1 - e^{-6} \quad \Rightarrow \quad C_2 = 2e^6 - 1.$$

Therefore,  $y_2(x) = -1 + (2e^6 - 1)e^{-2x}$ , and the continuous solution to the given initial value problem on  $[0, \infty)$  is

$$y(x) = \begin{cases} 1 - e^{-2x}, & 0 \leq x \leq 3, \\ -1 + (2e^6 - 1)e^{-2x}, & x > 3. \end{cases}$$

The graph of this function is shown in Fig. **2-C**, page 72.

- 34. (a)** Since  $P(x)$  is continuous on  $(a, b)$ , its antiderivatives given by  $\int P(x)dx$  are continuously differentiable, and therefore continuous, functions on  $(a, b)$ . Since the function  $e^x$  is continuous on  $(-\infty, \infty)$ , composite functions  $\mu(x) = e^{\int P(x)dx}$  are continuous on  $(a, b)$ . The range of the exponential function is  $(0, \infty)$ . This implies that  $\mu(x)$  is positive with any choice of the integration constant. Using the chain rule, we conclude that

$$\frac{d\mu(x)}{dx} = e^{\int P(x)dx} \frac{d}{dx} \left( \int P(x)dx \right) = \mu(x)P(x)$$

for any  $x$  on  $(a, b)$ .

- (b)** Differentiating (8), we apply the product rule and obtain

$$\frac{dy}{dx} = -\mu^{-2}\mu' \left( \int \mu Q dx + C \right) + \mu^{-1}\mu Q = -\mu^{-1}P \left( \int \mu Q dx + C \right) + Q,$$

and so

$$\frac{dy}{dx} + Py = \left[ -\mu^{-1}P \left( \int \mu Q dx + C \right) + Q \right] + P \left[ \mu^{-1} \left( \int \mu Q dx + C \right) \right] = Q.$$

(c) Suggested choice of the antiderivative and the constant  $C$  yields

$$y(x_0) = \mu(x)^{-1} \left( \int_{x_0}^x \mu Q dx + y_0 \mu(x_0) \right) \Big|_{x=x_0} = \mu(x_0)^{-1} y_0 \mu(x_0) = y_0.$$

(d) We assume that  $y(x)$  is a solution to the initial value problem (15). Since  $\mu(x)$  is a continuous positive function on  $(a, b)$ , the equation (5) is equivalent to (4). Since, from the part (a), the left-hand side of (5) is the derivative of the product  $\mu(x)y(x)$ , this function must be an antiderivative of the right-hand side, which is  $\mu(x)Q(x)$ . Thus, we come up with (8), where the integral means one of the antiderivatives, for example, the one suggested in the part (c) (which has zero value at  $x_0$ ). Substituting  $x = x_0$  into (8), we conclude that

$$y_0 = y(x_0) = \mu(x_0)^{-1} \left( \int \mu Q dx + C \right) \Big|_{x=x_0} = C \mu(x_0)^{-1},$$

and so  $C = y_0 \mu(x_0)$  is uniquely defined.

**36. (a)** If  $\mu(x) = \exp(\int P dx)$  and  $y_h(x) = \mu(x)^{-1}$ , then

$$\frac{dy_h}{dx} = (-1)\mu(x)^{-2} \frac{d\mu(x)}{dx} = -\mu(x)^{-2} \mu(x)P(x) = -\mu(x)^{-1}P(x)$$

and so

$$\frac{dy_h}{dx} + P(x)y_h = -\mu(x)^{-1}P(x) + P(x)\mu(x)^{-1} = 0,$$

i.e.,  $y_h$  is a solution to the equation  $y' + Py = 0$ . Now, the formula (8) yields

$$y = \mu(x)^{-1} \left( \int \mu(x)Q(x)dx + C \right) = y_h(x)v(x) + Cy_h(x) = y_p(x) + Cy_h(x),$$

where  $v(x) = \int \mu(x)Q(x)dx$ .

(b) Separating variables in (22) and integrating, we obtain

$$\frac{dy}{y} = -\frac{3dx}{x} \quad \Rightarrow \quad \int \frac{dy}{y} = -\int \frac{3dx}{x} \quad \Rightarrow \quad \ln |y| = -3 \ln x + C.$$

Since we need just one solution  $y_h$ , we take  $C = 0$

$$\ln |y| = -3 \ln x \quad \Rightarrow \quad y = \pm x^{-3},$$

and we choose, say,  $y_h = x^{-3}$ .

## Chapter 2

(c) Substituting  $y_p = v(x)y_h(x) = v(x)x^{-3}$  into (21), we get

$$\frac{dv}{dx}y_h + v\frac{dy_h}{dx} + \frac{3}{x}vy_h = \frac{dv}{dx}y_h + v\left(\frac{dy_h}{dx} + \frac{3}{x}y_h\right) = \frac{dv}{dx}y_h = x^2.$$

Therefore,  $dv/dx = x^2/y_h = x^5$ .

(d) Integrating yields

$$v(x) = \int x^5 dx = \frac{x^6}{6}.$$

(We have chosen zero integration constant.)

(e) The function

$$y = Cy_h + vy_h = Cx^{-3} + \frac{x^3}{6}$$

is a general solution to (21) because

$$\begin{aligned}\frac{dy}{dx} + \frac{3}{x}y &= \frac{d}{dx}\left(Cx^{-3} + \frac{x^3}{6}\right) + \frac{3}{x}\left(Cx^{-3} + \frac{x^3}{6}\right) \\ &= \left(-3Cx^{-4} + \frac{x^2}{2}\right) + \left(3Cx^{-4} + \frac{x^2}{2}\right) = x^2.\end{aligned}$$

38. Dividing both sides of (6) by  $\mu$  and multiplying by  $dx$  yields

$$\begin{aligned}\frac{d\mu}{\mu} = Pdx &\Rightarrow \int \frac{d\mu}{\mu} = \int Pdx \\ \Rightarrow \ln|\mu| = \int Pdx &\Rightarrow \mu = \pm \exp\left(\int Pdx\right).\end{aligned}$$

Choosing the positive sign, we obtain (7).

### EXERCISES 2.4: Exact Equations

2. This equation is not separable because the coefficient  $x^{10/3} - 2y$  cannot be written as a product  $f(x)g(y)$ . Writing the equation in the form

$$x\frac{dy}{dx} - 2y = -x^{10/3},$$

we see that the equation is linear. Since  $M(x, y) = x^{10/3} - 2y$ ,  $N(x, y) = x$ ,

$$\frac{\partial M}{\partial y} = -2 \neq \frac{\partial N}{\partial x} = 1,$$

and so the equation is not exact.

4. First we note that  $M(x, y) = \sqrt{-2y - y^2}$  depends only on  $y$  and  $N(x, y) = 3 + 2x - x^2$  depends only on  $x$ . So, the equation is separable. It is not linear with  $x$  as independent variable because  $M(x, y)$  is not a linear function of  $y$ . Similarly, it is not linear with  $y$  as independent variable because  $N(x, y)$  is not a linear function of  $x$ . Computing

$$\begin{aligned}\frac{\partial M}{\partial y} &= \frac{1}{2} (-2y - y^2)^{-1/2} (-2 - 2y) = -\frac{1 + y}{\sqrt{-2y - y^2}}, \\ \frac{\partial N}{\partial x} &= 2 - 2x,\end{aligned}$$

we see that the equation (5) in Theorem 2 is not satisfied. Therefore, the equation is not exact.

6. It is separable, linear with  $x$  as independent variable, and not exact because

$$\frac{\partial M}{\partial y} = x \neq \frac{\partial N}{\partial x} = 0.$$

8. Here,  $M(x, y) = 2x + y \cos(xy)$ ,  $N(x, y) = x \cos(xy) - 2y$ . Since  $M(x, y)/N(x, y)$  cannot be expressed as a product  $f(x)g(y)$ , the equation is not separable. We also conclude that it is not linear because  $M(x, y)/N(x, y)$  is not a linear function of  $y$  and  $N(x, y)/M(x, y)$  is not a linear function of  $x$ . Taking partial derivatives

$$\frac{\partial M}{\partial y} = \cos(xy) - xy \sin(xy) = \frac{\partial N}{\partial x},$$

we see that the equation is exact.

10. In this problem,  $M(x, y) = 2x + y$ ,  $N(x, y) = x - 2y$ . Thus,  $M_y = N_x = 1$ , and the equation is exact. We find

$$\begin{aligned}F(x, y) &= \int (2x + y) dx = x^2 + xy + g(y), \\ \frac{\partial F}{\partial y} &= x + g'(y) = N(x, y) = x - 2y \\ \Rightarrow g'(y) &= -2y \quad \Rightarrow \quad g(y) = \int (-2y) dy = -y^2 \\ \Rightarrow F(x, y) &= x^2 + xy - y^2,\end{aligned}$$

and so  $x^2 + xy - y^2 = C$  is a general solution.

12. We compute

$$\frac{\partial M}{\partial y} = e^x \cos y = \frac{\partial N}{\partial x}.$$

## Chapter 2

Thus, the equation is exact.

$$\begin{aligned} F(x, y) &= \int (e^x \sin y - 3x^2) dx = e^x \sin y - x^3 + g(y), \\ \frac{\partial F}{\partial y} &= e^x \cos y + g'(y) = e^x \cos y - \frac{1}{3} y^{-2/3} \\ \Rightarrow \quad g'(y) &= -\frac{1}{3} y^{-2/3} \quad \Rightarrow \quad g(y) = \frac{1}{3} \int y^{-2/3} dy = y^{1/3}. \end{aligned}$$

So,  $e^x \sin y - x^3 + \sqrt[3]{y} = C$  is a general solution.

14. Since  $M(t, y) = e^t(y - t)$ ,  $N(t, y) = 1 + e^t$ , we find that

$$\frac{\partial M}{\partial y} = e^t = \frac{\partial N}{\partial t}.$$

Then

$$\begin{aligned} F(t, y) &= \int (1 + e^t) dy = (1 + e^t)y + h(t), \\ \frac{\partial F}{\partial t} &= e^t y + h'(t) = e^t(y - t) \quad \Rightarrow \quad h'(t) = -te^t \\ \Rightarrow \quad h(t) &= - \int te^t dt = -(t - 1)e^t, \end{aligned}$$

and a general solution is given by

$$(1 + e^t)y - (t - 1)e^t = C \quad \Rightarrow \quad y = \frac{(t - 1)e^t + C}{1 + e^t}.$$

16. Computing

$$\begin{aligned} \frac{\partial M}{\partial y} &= \frac{\partial}{\partial y} (ye^{xy} - y^{-1}) = e^{xy} + xy e^{xy} + y^{-2}, \\ \frac{\partial N}{\partial x} &= \frac{\partial}{\partial x} (xe^{xy} + xy^{-2}) = e^{xy} + xy e^{xy} + y^{-2}, \end{aligned}$$

we see that the equation is exact. Therefore,

$$F(x, y) = \int (ye^{xy} - y^{-1}) dx = e^{xy} - xy^{-1} + g(y).$$

So,

$$\frac{\partial F}{\partial y} = xe^{xy} + xy^{-2} + g'(y) = N(x, y) \quad \Rightarrow \quad g'(y) = 0.$$

Thus,  $g(y) = 0$ , and the answer is  $e^{xy} - xy^{-1} = C$ .

18. Since

$$\frac{\partial M}{\partial y} = \frac{\partial N}{\partial x} = 2y^2 + \sin(x + y),$$

the equation is exact. We find

$$\begin{aligned} F(x, y) &= \int [2x + y^2 - \cos(x + y)] dx = x^2 + xy^2 - \sin(x + y) + g(y), \\ \frac{\partial F}{\partial y} &= 2xy - \cos(x + y) + g'(y) = 2xy - \cos(x + y) - e^y \\ \Rightarrow \quad g'(y) &= -e^y \quad \Rightarrow \quad g(y) = -e^y. \end{aligned}$$

Therefore,

$$F(x, y) = x^2 + xy^2 - \sin(x + y) - e^y = C$$

gives a general solution.

20. We find

$$\begin{aligned} \frac{\partial M}{\partial y} &= \frac{\partial}{\partial y} [y \cos(xy)] = \cos(xy) - xy \sin(xy), \\ \frac{\partial N}{\partial x} &= \frac{\partial}{\partial x} [x \cos(xy)] = \cos(xy) - xy \sin(xy). \end{aligned}$$

Therefore, the equation is exact and

$$\begin{aligned} F(x, y) &= \int (x \cos(xy) - y^{-1/3}) dy = \sin(xy) - \frac{3}{2} y^{2/3} + h(x) \\ \frac{\partial F}{\partial x} &= y \cos(xy) + h'(x) = \frac{2}{\sqrt{1-x^2}} + y \cos(xy) \\ \Rightarrow \quad h'(x) &= \frac{2}{\sqrt{1-x^2}} \quad \Rightarrow \quad h(x) = 2 \arcsin x, \end{aligned}$$

and a general solution is given by

$$\sin(xy) - \frac{3}{2} y^{2/3} + 2 \arcsin x = C.$$

22. In Problem 16, we found that a general solution to this equation is

$$e^{xy} - xy^{-1} = C.$$

Substituting the initial condition,  $y(1) = 1$ , yields  $e - 1 = C$ . So, the answer is

$$e^{xy} - xy^{-1} = e - 1.$$



## Chapter 2

24. First, we check the given equation for exactness.

$$\frac{dM}{dx} = e^t = \frac{\partial N}{\partial t}.$$

So, it is exact. We find

$$\begin{aligned} F(t, x) &= \int (e^t - 1) dx = x(e^t - 1) + g(t), \\ \frac{\partial F}{\partial t} &= xe^t + g'(t) = xe^t + 1 \quad \Rightarrow \quad g(t) = \int dt = t \\ \Rightarrow \quad x(e^t - 1) + t &= C \end{aligned}$$

is a general solution. With  $x(1) = 1$ , we get

$$(1)(e - 1) + 1 = C \quad \Rightarrow \quad C = e,$$

and the solution is given by

$$x = \frac{e - t}{e^t - 1}.$$

26. Taking partial derivatives  $M_y$  and  $N_x$ , we find that the equation is exact. So,

$$\begin{aligned} F(x, y) &= \int (\tan y - 2) dx = x(\tan y - 2) + g(y), \\ \frac{\partial F}{\partial y} &= x \sec^2 y + g'(y) = x \sec^2 y + y^{-1} \\ \Rightarrow \quad g'(y) &= y^{-1} \quad \Rightarrow \quad g(y) = \ln |y|, \end{aligned}$$

and

$$x(\tan y - 2) + \ln |y| = C$$

is a general solution. Substituting  $y(0) = 1$  yields  $C = 0$ . Therefore, the answer is

$$x(\tan y - 2) + \ln y = 0.$$

(We removed the absolute value sign in the logarithmic function because  $y(0) > 0$ .)

28. (a) Computing

$$\frac{\partial M}{\partial y} = \cos(xy) - xy \sin(xy),$$

which must be equal to  $\partial N/\partial x$ , we find that

$$\begin{aligned} N(x, y) &= \int [\cos(xy) - xy \sin(xy)] dx \\ &= \int [x \cos(xy)]'_x dx = x \cos(xy) + g(y). \end{aligned}$$

(b) Since

$$\frac{\partial M}{\partial y} = (1 + xy)e^{xy} - 4x^3 = \frac{\partial N}{\partial x},$$

we conclude that

$$N(x, y) = \int [(1 + xy)e^{xy} - 4x^3] dx = xe^{xy} - x^4 + g(y).$$

30. (a) Differentiating, we find that

$$\begin{aligned}\frac{\partial M}{\partial y} &= 5x^2 + 12x^3y + 8xy, \\ \frac{\partial N}{\partial x} &= 6x^2 + 12x^3y + 6xy.\end{aligned}$$

Since  $M_y \neq N_x$ , the equation is not exact.

(b) Multiplying given equation by  $x^n y^m$  and taking partial derivatives of new coefficients yields

$$\begin{aligned}\frac{d}{dy} (5x^{n+2}y^{m+1} + 6x^{n+3}y^{m+2} + 4x^{n+1}y^{m+2}) \\ &= 5(m+1)x^{n+2}y^m + 6(m+2)x^{n+3}y^{m+1} + 4(m+2)x^{n+1}y^{m+1} \\ \frac{d}{dx} (2x^{n+3}y^m + 3x^{n+4}y^{m+1} + 3x^{n+2}y^{m+1}) \\ &= 2(n+3)x^{n+2}y^m + 3(n+4)x^{n+3}y^{m+1} + 3(n+2)x^{n+1}y^{m+1}.\end{aligned}$$

In order that these polynomials are equal, we must have equal coefficients at similar monomials. Thus,  $n$  and  $m$  must satisfy the system

$$\begin{cases} 5(m+1) = 2(n+3) \\ 6(m+2) = 3(n+4) \\ 4(m+2) = 3(n+2). \end{cases}$$

Solving, we obtain  $n = 2$  and  $m = 1$ . Therefore, multiplying the given equation by  $x^2y$  yields an exact equation.

(c) We find

$$\begin{aligned}F(x, y) &= \int (5x^4y^2 + 6x^5y^3 + 4x^3y^3) dx \\ &= x^5y^2 + x^6y^3 + x^4y^3 + g(y).\end{aligned}$$

Therefore,

$$\frac{\partial F}{\partial y} = 2x^5y + 3x^6y^2 + 3x^4y^2 + g'(y)$$

## Chapter 2

$$= 2x^5y + 3x^6y^2 + 3x^4y^2 \quad \Rightarrow \quad g(y) = 0,$$

and a general solution to the given equation is

$$x^5y^2 + x^6y^3 + x^4y^3 = C.$$

- 32. (a)** The slope of the orthogonal curves, say  $m_{\perp}$ , must be  $-1/m$ , where  $m$  is the slope of the original curves. Therefore, we have

$$m_{\perp} = \frac{F_y(x, y)}{F_x(x, y)} \quad \Rightarrow \quad \frac{dy}{dx} = \frac{F_y(x, y)}{F_x(x, y)} \quad \Rightarrow \quad F_y(x, y) dx - F_x(x, y) dy = 0.$$

- (b)** Let  $F(x, y) = x^2 + y^2$ . Then we have  $F_x(x, y) = 2x$  and  $F_y(x, y) = 2y$ . Plugging these expressions into the final result of part (a) gives

$$2y dx - 2x dy = 0 \quad \Rightarrow \quad y dx - x dy = 0.$$

To find the orthogonal trajectories, we must solve this differential equation. To this end, note that this equation is separable and thus

$$\begin{aligned} \int \frac{1}{x} dx &= \int \frac{1}{y} dy \quad \Rightarrow \quad \ln|x| = \ln|y| + C \\ \Rightarrow e^{\ln|x| - C} &= e^{\ln|y|} \quad \Rightarrow \quad y = kx, \quad \text{where } k = \pm e^{-C}. \end{aligned}$$

Therefore, the orthogonal trajectories are lines through the origin.

- (c)** Let  $F(x, y) = xy$ . Then we have  $F_x(x, y) = y$  and  $F_y(x, y) = x$ . Plugging these expressions into the final result of part (a) gives

$$x dx - y dy = 0.$$

To find the orthogonal trajectories, we must solve this differential equation. To this end, note that this equation is separable and thus

$$\int x dx = \int y dy \quad \Rightarrow \quad \frac{x^2}{2} = \frac{y^2}{2} + C \quad \Rightarrow \quad x^2 - y^2 = k,$$

where  $k := 2C$ . Therefore, the orthogonal trajectories are hyperbolas.

- 34.** To use the method described in Problem 32, we rewrite the equation  $x^2 + y^2 = kx$  in the form  $x + x^{-1}y^2 = k$ . Thus,  $F(x, y) = x + x^{-1}y^2$ ,

$$\frac{\partial F}{\partial x} = 1 - x^{-2}y^2, \quad \frac{\partial F}{\partial y} = 2x^{-1}y.$$

Substituting these derivatives in the equation given in Problem 32(b), we get the required. Multiplying the equation by  $x^n y^m$ , we obtain

$$2x^{n-1}y^{m+1}dx + (x^{n-2}y^{m+2} - x^n y^m) dy = 0.$$

Therefore,

$$\begin{aligned}\frac{\partial M}{\partial y} &= 2(m+1)x^{n-1}y^m, \\ \frac{\partial N}{\partial x} &= (n-2)x^{n-3}y^{m+2} - nx^{n-1}y^m.\end{aligned}$$

Thus, to have an exact equation,  $n$  and  $m$  must satisfy

$$\begin{cases} n - 2 = 0 \\ 2(m + 1) = -n. \end{cases}$$

Solving, we obtain  $n = 2$ ,  $m = -2$ . With this choice, the equation becomes

$$2xy^{-1}dx + (1 - x^2y^{-2}) dy = 0,$$

and so

$$\begin{aligned}G(x, y) &= \int M(x, y)dx = \int 2xy^{-1}dx = x^2y^{-1} + g(y), \\ \frac{\partial G}{\partial y} &= -x^2y^{-2} + g'(y) = N(x, y) = 1 - x^2y^{-2}.\end{aligned}$$

Therefore,  $g(y) = y$ , and the family of orthogonal trajectories is given by  $x^2y^{-1} + y = C$ . Writing this equation in the form  $x^2 + y^2 - Cy = 0$ , we see that, given  $C$ , the trajectory is the circle centered at  $(0, C/2)$  and of radius  $C/2$ .

Several given curves and their orthogonal trajectories are shown in Fig. **2-D**, page 72.

- 36.** The first equation in (4) follows from (9) and the Fundamental Theorem of Calculus.

$$\frac{\partial F}{\partial x} = \frac{\partial}{\partial x} \left[ \int_{x_0}^x M(t, y)dt + g(y) \right] = M(t, y)|_{t=x} = M(x, y).$$

For the second equation in (4),

$$\frac{\partial F}{\partial y} = \frac{\partial}{\partial y} \left[ \int_{x_0}^x M(t, y)dt + g(y) \right]$$

$$\begin{aligned}
&= \frac{\partial}{\partial y} \int_{x_0}^x M(t, y) dt + g'(y) \\
&= \frac{\partial}{\partial y} \int_{x_0}^x M(t, y) dt + \left[ N(x, y) - \frac{\partial}{\partial y} \int_{x_0}^x M(t, y) dt \right] = N(x, y).
\end{aligned}$$

**EXERCISES 2.5: Special Integrating Factors**

2. This equation is neither separable, nor linear. Since

$$\frac{\partial M}{\partial y} = x^{-1} \neq \frac{\partial N}{\partial x} = y,$$

it is not exact either. But

$$\frac{M_y - N_x}{N} = \frac{x^{-1} - y}{xy - 1} = \frac{1 - xy}{x(xy - 1)} = -\frac{1}{x}$$

is a function of just  $x$ . So, there exists an integrating factor  $\mu(x)$ , which makes the equation exact.

4. This equation is also not separable and not linear. Computing

$$\frac{\partial M}{\partial y} = 1 = \frac{\partial N}{\partial x},$$

we see that it is exact.

6. It is not separable, but linear with  $x$  as independent variable. Since

$$\frac{\partial M}{\partial y} = 4 \neq \frac{\partial N}{\partial x} = 1,$$

this equation is not exact, but it has an integrating factor  $\mu(x)$ , because

$$\frac{M_y - N_x}{N} = \frac{3}{x}$$

depends on  $x$  only.

8. We find that

$$\frac{\partial M}{\partial y} = 2x, \quad \frac{\partial N}{\partial x} = -6x \quad \Rightarrow \quad \frac{N_x - M_y}{M} = \frac{-8x}{2xy} = -\frac{4}{y}$$

depends just on  $y$ . So, an integrating factor is

$$\mu(y) = \exp \left[ \int \left( -\frac{4}{y} \right) dy \right] = \exp(-4 \ln y) = y^{-4}.$$

So, multiplying the given equation by  $y^{-4}$ , we get an exact equation

$$2xy^{-3}dx + (y^{-2} - 3x^2y^{-4}) dy = 0.$$

Thus,

$$\begin{aligned} F(x, y) &= \int 2xy^{-3}dx = x^2y^{-3} + g(y), \\ \frac{\partial F}{\partial y} &= -3x^2y^{-4} + g'(y) = y^{-2} - 3x^2y^{-4} \\ \Rightarrow \quad g'(y) &= y^{-2} \quad \Rightarrow \quad g(y) = -y^{-1}. \end{aligned}$$

This yields a solution

$$F(x, y) = x^2y^{-3} - y^{-1} = C,$$

which together with the lost solution  $y \equiv 0$ , gives a general solution to the given equation.

**10.** Since

$$\frac{\partial M}{\partial y} = 1, \quad \frac{\partial N}{\partial x} = -1, \quad \text{and} \quad \frac{M_y - N_x}{N} = \frac{2}{-x},$$

the equation has an integrating factor

$$\mu(x) = \exp \left[ \int \left( -\frac{2}{x} \right) dx \right] = \exp(-2 \ln x) = x^{-2}.$$

Therefore, the equation

$$x^{-2} [(x^4 - x + y) dx - xdy] = (x^2 - x^{-1} + x^{-2}y) dx - x^{-1}dy = 0$$

is exact. Therefore,

$$\begin{aligned} F(x, y) &= \int (-x^{-1}) dy = -x^{-1}y + h(x), \\ \frac{\partial F}{\partial x} &= x^{-2}y + h'(x) = x^2 - x^{-1} + x^{-2}y \\ \Rightarrow \quad h'(x) &= x^2 - x^{-1} \quad \Rightarrow \quad h(x) = \frac{x^3}{3} - \ln |x| \\ \Rightarrow \quad -\frac{y}{x} + \frac{x^3}{3} - \ln |x| &= C \quad \Rightarrow \quad y = \frac{x^4}{3} - x \ln |x| - Cx. \end{aligned}$$

Together with the lost solution,  $x \equiv 0$ , this gives a general solution to the problem.

**12.** Here,  $M(x, y) = 2xy^3 + 1$ ,  $N(x, y) = 3x^2y^2 - y^{-1}$ . Since

$$\frac{\partial M}{\partial y} = 6xy^2 = \frac{\partial N}{\partial x},$$

## Chapter 2

the equation is exact. So, we find that

$$\begin{aligned} F(x, y) &= \int (2xy^3 + 1) dx = x^2y^3 + x + g(y), \\ \frac{\partial F}{\partial y} &= 3x^2y^2 + g'(y) = 3x^2y^2 - y^{-1} \\ \Rightarrow \quad g'(y) &= -y^{-1} \quad \Rightarrow \quad g(y) = -\ln |y|, \end{aligned}$$

and the given equation has a general solution

$$x^2y^3 + x - \ln |y| = C.$$

14. Multiplying the given equation by  $x^n y^m$  yields

$$(12x^n y^m + 5x^{n+1} y^{m+1}) dx + (6x^{n+1} y^{m-1} + 3x^{n+2} y^m) dy = 0.$$

Therefore,

$$\begin{aligned} \frac{\partial M}{\partial y} &= 12m x^n y^{m-1} + 5(m+1)x^{n+1} y^m, \\ \frac{\partial N}{\partial x} &= 6(n+1)x^n y^{m-1} + 3(n+2)x^{n+1} y^m. \end{aligned}$$

Matching the coefficients, we get a system

$$\begin{cases} 12m = 6(n+1) \\ 5(m+1) = 3(n+2) \end{cases}$$

to determine  $n$  and  $m$ . This system has the solution  $n = 3$ ,  $m = 2$ . Thus, the given equation multiplied by  $x^3 y^2$ , that is,

$$(12x^3 y^2 + 5x^4 y^3) dx + (6x^4 y + 3x^5 y^2) dy = 0,$$

is exact. We compute

$$\begin{aligned} F(x, y) &= \int (12x^3 y^2 + 5x^4 y^3) dx = 3x^4 y^2 + x^5 y^3 + g(y), \\ \frac{\partial F}{\partial y} &= 6x^4 y + 3x^5 y^2 + g'(y) = 6x^4 y + 3x^5 y^2 \\ \Rightarrow \quad g'(y) &= 0 \quad \Rightarrow \quad g(y) = 0, \end{aligned}$$

and so  $3x^4 y^2 + x^5 y^3 = C$  is a general solution to the given equation.

16. (a) An equation  $Mdx + Ndy = 0$  has an integrating factor  $\mu(x + y)$  if and only if the equation

$$\mu(x + y)M(x, y)dx + \mu(x + y)N(x, y)dy = 0$$

is exact. According to Theorem 2, Section 2.4, this means that

$$\frac{\partial}{\partial y} [\mu(x + y)M(x, y)] = \frac{\partial}{\partial x} [\mu(x + y)N(x, y)] .$$

Applying the product and chain rules yields

$$\mu'(x + y)M(x, y) + \mu(x + y)\frac{\partial M(x, y)}{\partial y} = \mu'(x + y)N(x, y) + \mu(x + y)\frac{\partial N(x, y)}{\partial x} .$$

Collecting similar terms yields

$$\begin{aligned} \mu'(x + y) [M(x, y) - N(x, y)] &= \mu(x + y) \left[ \frac{\partial N(x, y)}{\partial x} - \frac{\partial M(x, y)}{\partial y} \right] \\ \Leftrightarrow \frac{\partial N/\partial x - \partial M/\partial y}{M - N} &= \frac{\mu'(x + y)}{\mu(x + y)} . \end{aligned} \quad (2.1)$$

The right-hand side of (2.1) depends on  $x + y$  only so the left-hand side does.

To find an integrating factor, we let  $s = x + y$  and denote

$$G(s) = \frac{\partial N/\partial x - \partial M/\partial y}{M - N} .$$

Then (2.1) implies that

$$\begin{aligned} \frac{\mu'(s)}{\mu(s)} = G(s) &\Rightarrow \ln |\mu(s)| = \int G(s) ds \\ \Rightarrow |\mu(s)| = \exp \left[ \int G(s) ds \right] &\Rightarrow \mu(s) = \pm \exp \left[ \int G(s) ds \right] . \end{aligned} \quad (2.2)$$

In this formula, we can choose either sign and any integration constant.

- (b) We compute

$$\frac{\partial N/\partial x - \partial M/\partial y}{M - N} = \frac{(1 + y) - (1 + x)}{(3 + y + xy) - (3 + x + xy)} = 1 .$$

Applying formula (2.2), we obtain

$$\mu(s) = \exp \left[ \int (1) ds \right] = e^s \quad \Rightarrow \quad \mu(x + y) = e^{x+y} ,$$

Multiplying the given equation by  $\mu(x + y)$ , we get an exact equation

$$e^{x+y}(3 + y + xy)dx + e^{x+y}(3 + x + xy)dy = 0$$



## Chapter 2

and follow the procedure of solving exact equations, Section 2.4.

$$\begin{aligned} F(x, y) &= \int e^{x+y}(3 + y + xy) dx = e^y \left[ (3 + y) \int e^x dx + y \int xe^x dx \right] \\ &= e^y [(3 + y)e^x + y(x - 1)e^x] + h(y) = e^{x+y}(3 + xy) + h(y). \end{aligned}$$

Taking the partial derivative of  $F$  with respect to  $y$ , we find  $h(y)$ .

$$\begin{aligned} \frac{\partial F}{\partial y} &= e^{x+y}(3 + xy + x) + h'(y) = e^{x+y}N(x, y) = e^{x+y}(3 + x + xy) \\ \Rightarrow \quad h'(y) &= 0 \quad \Rightarrow \quad h(y) = 0. \end{aligned}$$

Thus, a general solution is

$$e^{x+y}(3 + xy) = C.$$

- 18.** The given condition,  $xM(x, y) + yN(x, y) \equiv 0$ , is equivalent to  $yN(x, y) \equiv -xM(x, y)$ . In particular, substituting  $x = 0$ , we obtain

$$yN(0, y) \equiv -(0)M(0, y) \equiv 0.$$

This implies that  $x \equiv 0$  is a solution to the given equation.

To obtain other solutions, we multiply the equation by  $x^{-1}y$ . This gives

$$\begin{aligned} x^{-1}yM(x, y)dx + x^{-1}yN(x, y)dy &= x^{-1}yM(x, y)dx - x^{-1}xM(x, y)dy \\ &= xM(x, y)(x^{-2}ydx - x^{-1}dy) = -xM(x, y)d(x^{-1}y) = 0. \end{aligned}$$

Therefore,  $x^{-1}y = C$  or  $y = Cx$ .

Thus, a general solution is

$$y = Cx \quad \text{and} \quad x \equiv 0.$$

- 20.** For the equation

$$e^{\int P(x)dx} [P(x)y - Q(x)] dx + e^{\int P(x)dx} dy = 0,$$

we compute

$$\begin{aligned} \frac{\partial M}{\partial y} &= \frac{\partial}{\partial y} \left( e^{\int P(x)dx} [P(x)y - Q(x)] \right) = e^{\int P(x)dx} P(x), \\ \frac{\partial N}{\partial x} &= \frac{\partial}{\partial x} \left( e^{\int P(x)dx} \right) = e^{\int P(x)dx} \frac{d}{dx} \left( \int P(x)dx \right) = e^{\int P(x)dx} P(x). \end{aligned}$$

Therefore,  $\partial M/\partial y = \partial N/\partial x$ , and the equation is exact.

**EXERCISES 2.6: Substitutions and Transformations**

2. We can write the equation in the form

$$\frac{dx}{dt} = \frac{x^2 - t^2}{2tx} = \frac{1}{2} \left( \frac{x}{t} - \frac{t}{x} \right),$$

which shows that it is homogeneous. At the same time, it is a Bernoulli equation because it can be written as

$$\frac{dx}{dt} - \frac{1}{2t}x = -\frac{t}{2}x^{-1},$$

4. This is a Bernoulli equation.

6. Dividing this equation by  $\theta d\theta$ , we obtain

$$\frac{dy}{d\theta} - \frac{1}{\theta}y = \frac{1}{\sqrt{\theta}}y^{1/2}.$$

Therefore, it is a Bernoulli equation. It can also be written in the form

$$\frac{dy}{d\theta} = \frac{y}{\theta} + \sqrt{\frac{y}{\theta}},$$

and so it is homogeneous too.

8. We can rewrite the equation in the form

$$\frac{dy}{dx} = \frac{\sin(x+y)}{\cos(x+y)} = \tan(x+y).$$

Thus, it is of the form  $dy/dx = G(ax+by)$  with  $G(t) = \tan t$ .

10. Writing the equation in the form

$$\frac{dy}{dx} = \frac{xy + y^2}{x^2} = \frac{y}{x} + \left(\frac{y}{x}\right)^2$$

and making the substitution  $v = y/x$ , we obtain

$$\begin{aligned} v + x \frac{dv}{dx} = v + v^2 &\quad \Rightarrow \quad \frac{dv}{v^2} = \frac{dx}{x} &\quad \Rightarrow \quad \int \frac{dv}{v^2} = \int \frac{dx}{x} \\ \Rightarrow \quad -\frac{1}{v} = \ln|x| + C &\quad \Rightarrow \quad -\frac{x}{y} = \ln|x| + C &\quad \Rightarrow \quad y = -\frac{x}{\ln|x| + C}. \end{aligned}$$

In addition, separating variables, we lost a solution  $v \equiv 0$ , corresponding to  $y \equiv 0$ .

## Chapter 2

12. From

$$\frac{dy}{dx} = -\frac{x^2 + y^2}{2xy} = -\frac{1}{2} \left( \frac{x}{y} + \frac{y}{x} \right),$$

making the substitution  $v = y/x$ , we obtain

$$\begin{aligned} v + x \frac{dv}{dx} &= -\frac{1}{2} \left( \frac{1}{v} + v \right) = -\frac{1+v^2}{2v} &\Rightarrow & x \frac{dv}{dx} = -\frac{1+v^2}{2v} - v = -\frac{1+3v^2}{2v} \\ \Rightarrow & \frac{2v dv}{1+3v^2} = -\frac{dx}{x} &\Rightarrow & \int \frac{2v dv}{1+3v^2} = -\int \frac{dx}{x} \\ \Rightarrow & \frac{1}{3} \ln(1+3v^2) = -\ln|x| + C_2 &\Rightarrow & 1+3v^2 = C_1|x|^{-3}, \end{aligned}$$

where  $C_1 = e^{3C_2}$  is any positive constant. Making the back substitution, we finally get

$$\begin{aligned} 1 + 3 \left( \frac{y}{x} \right)^2 &= \frac{C_1}{|x|^3} &\Rightarrow & 3 \left( \frac{y}{x} \right)^2 = \frac{C_1}{|x|^3} - 1 = \frac{C_1 - |x|^3}{|x|^3} \\ \Rightarrow & 3|x|y^2 = C_1 - |x|^3 &\Rightarrow & 3|x|y^2 + |x|^3 = C_1 &\Rightarrow & 3xy^2 + x^3 = C, \end{aligned}$$

where  $C = \pm C_1$  is any nonzero constant.

14. Substituting  $v = y/\theta$  yields

$$\begin{aligned} v + \theta \frac{dv}{d\theta} &= \sec v + v &\Rightarrow & \theta \frac{dv}{d\theta} = \sec v \\ \Rightarrow & \cos v dv = \frac{d\theta}{\theta} &\Rightarrow & \int \cos v dv = \int \frac{d\theta}{\theta} \\ \Rightarrow & \sin v = \ln|\theta| + C &\Rightarrow & y = \theta \arcsin(\ln|\theta| + C). \end{aligned}$$

16. We rewrite the equation in the form

$$\frac{dy}{dx} = \frac{y}{x} \left( \ln \frac{y}{x} + 1 \right)$$

and substitute  $v = y/x$  to get

$$\begin{aligned} v + x \frac{dv}{dx} &= v(\ln v + 1) &\Rightarrow & x \frac{dv}{dx} = v \ln v &\Rightarrow & \int \frac{dv}{v \ln v} = \int \frac{dx}{x} \\ \Rightarrow & \ln|\ln v| = \ln|x| + C_1 &\Rightarrow & \ln v = \pm e^{C_1} x = Cx &\Rightarrow & v = e^{Cx}, \end{aligned}$$

where  $C \neq 0$  is any constant. Note that, separating variables, we lost a solution,  $v \equiv 1$ , which can be included in the above formula by letting  $C = 0$ . Thus we have  $v = e^{Cx}$ , where  $C$  is any constant. Substituting back  $y = xv$  yields a general solution

$$y = xe^{Cx}$$

to the given equation.

18. With  $z = x + y + 2$  and  $z' = 1 + y'$ , we have

$$\begin{aligned} \frac{dz}{dx} = z^2 + 1 &\Rightarrow \frac{dz}{z^2 + 1} = dx \Rightarrow \int \frac{dz}{z^2 + 1} = \int dx \\ \Rightarrow \arctan z = x + C &\Rightarrow x + y + 2 = z = \tan(x + C) \\ \Rightarrow y = \tan(x + C) - x - 2. \end{aligned}$$

20. Substitution  $z = x - y$  yields

$$\begin{aligned} 1 - \frac{dz}{dx} = \sin z &\Rightarrow \frac{dz}{dx} = 1 - \sin z \Rightarrow \frac{dz}{1 - \sin z} = dx \\ \Rightarrow \int \frac{dz}{1 - \sin z} = \int dx = x + C. \end{aligned}$$

The left-hand side integral can be found as follows.

$$\begin{aligned} \int \frac{dz}{1 - \sin z} &= \int \frac{(1 + \sin z)dz}{1 - \sin^2 z} = \int \frac{(1 + \sin z)dz}{\cos^2 z} \\ &= \int \sec^2 z + \int \tan z \sec z dz = \tan z + \sec z. \end{aligned}$$

Thus, a general solution is given implicitly by

$$\tan(x - y) + \sec(x - y) = x + C.$$

22. Dividing the equation by  $y^3$  yields

$$y^{-3} \frac{dy}{dx} - y^{-2} = e^{2x}.$$

We now make a substitution  $v = y^{-2}$  so that  $v' = -2y^{-3}y'$ , and get

$$\frac{dv}{dx} + 2v = -2e^{2x}.$$

This is a linear equation. So,

$$\begin{aligned} \mu(x) &= \exp\left(\int 2dx\right) = e^{2x}, \\ v(x) &= e^{-2x} \int (-2e^{2x}) e^{2x} dx = -(1/2)e^{-2x} (e^{4x} + C) = -\frac{e^{2x} + Ce^{-2x}}{2}. \end{aligned}$$

Therefore,

$$\frac{1}{y^2} = -\frac{e^{2x} + Ce^{-2x}}{2} \Rightarrow y = \pm \sqrt{-\frac{2}{e^{2x} + Ce^{-2x}}}.$$

Dividing the equation by  $y^3$ , we lost a constant solution  $y \equiv 0$ .

## Chapter 2

**24.** We divide this Bernoulli equation by  $y^{1/2}$  and make a substitution  $v = y^{1/2}$ .

$$\begin{aligned} y^{-1/2} \frac{dy}{dx} + \frac{1}{x-2} y^{1/2} &= 5(x-2) \\ \Rightarrow 2 \frac{dv}{dx} + \frac{1}{x-2} v &= 5(x-2) \quad \Rightarrow \quad \frac{dv}{dx} + \frac{1}{2(x-2)} v = \frac{5(x-2)}{2}. \end{aligned}$$

An integrating factor for this linear equation is

$$\mu(x) = \exp \left[ \int \frac{dx}{2(x-2)} \right] = \sqrt{|x-2|}.$$

Therefore,

$$\begin{aligned} v(x) &= \frac{1}{\sqrt{|x-2|}} \int \frac{5(x-2)\sqrt{|x-2|}}{2} dx \\ &= \frac{1}{\sqrt{|x-2|}} (|x-2|^{5/2} + C) = (x-2)^2 + C|x-2|^{-1/2}. \end{aligned}$$

Since  $y = v^2$ , we finally get

$$y = [(x-2)^2 + C|x-2|^{-1/2}]^2.$$

In addition,  $y \equiv 0$  is a (lost) solution.

**26.** Multiplying the equation by  $y^2$ , we get

$$y^2 \frac{dy}{dx} + y^3 = e^x.$$

With  $v = y^3$ ,  $v' = 3y^2 y'$ , the equation becomes

$$\begin{aligned} \frac{1}{3} \frac{dv}{dx} + v &= e^x \quad \Rightarrow \quad \frac{dv}{dx} + 3v = 3e^x \quad \Rightarrow \quad \frac{d}{dx} (e^{3x} v) = 3e^{4x} \\ \Rightarrow v &= e^{-3x} \int 3e^{4x} dx = \frac{3e^x}{4} + Ce^{-3x}. \end{aligned}$$

Therefore,

$$y = \sqrt[3]{v} = \sqrt[3]{\frac{3e^x}{4} + Ce^{-3x}}.$$

**28.** First, we note that  $y \equiv 0$  is a solution, which will be lost when we divide the equation by  $y^3$  and make a substitution  $v = y^{-2}$  to get a linear equation

$$y^{-3} \frac{dy}{dx} + y^{-2} + x = 0 \quad \Rightarrow \quad \frac{dv}{dx} - 2v = 2x.$$

An integrating factor for this equation is

$$\mu(x) = \exp \left[ \int (-2) dx \right] = e^{-2x}.$$

Thus,

$$\begin{aligned} v &= e^{2x} \int 2xe^{-2x} dx = e^{2x} \left( -xe^{-2x} + \int e^{-2x} dx \right) \\ &= e^{2x} \left( -xe^{-2x} - \frac{e^{-2x}}{2} + C \right) = -x - \frac{1}{2} + Ce^{2x}. \end{aligned}$$

So,

$$y = \pm v^{-1/2} = \pm \frac{1}{\sqrt{-x - \frac{1}{2} + Ce^{2x}}}.$$

**30.** We make a substitution

$$x = u + h, \quad y = v + k,$$

where  $h$  and  $k$  satisfy the system (14) in the text, i.e.,

$$\begin{cases} h + k - 1 = 0 \\ k - h - 5 = 0. \end{cases}$$

Solving yields  $h = -2$ ,  $k = 3$ . Thus,  $x = u - 2$  and  $y = v + 3$ . Since  $dx = du$ ,  $dy = dv$ , this substitution leads to the equation

$$(u + v)du + (v - u)dv = 0 \quad \Rightarrow \quad \frac{dv}{du} = \frac{u + v}{u - v} = \frac{1 + (v/u)}{1 - (v/u)}.$$

This is a homogeneous equation, and a substitution  $z = v/u$  ( $v' = z + uz'$ ) yields

$$\begin{aligned} z + u \frac{dz}{du} &= \frac{1 + z}{1 - z} \quad \Rightarrow \quad u \frac{dz}{du} = \frac{1 + z}{1 - z} - z = \frac{1 + z^2}{1 - z} \\ \Rightarrow \quad \frac{(1 - z)dz}{1 + z^2} &= \frac{du}{u} \\ \Rightarrow \quad \arctan z - \frac{1}{2} \ln(1 + z^2) &= \ln|u| + C_1 \\ \Rightarrow \quad 2 \arctan \frac{v}{u} - \ln[u^2(1 + z^2)] &= 2C_1 \\ \Rightarrow \quad 2 \arctan \frac{v}{u} - \ln(u^2 + v^2) &= C. \end{aligned}$$

The back substitution yields

$$2 \arctan \left( \frac{y - 3}{x + 2} \right) - \ln[(x + 2)^2 + (y - 3)^2] = C.$$

## Chapter 2

- 32.** To obtain a homogeneous equation, we make a substitution  $x = u + h$ ,  $y = v + k$  with  $h$  and  $k$  satisfying

$$\begin{cases} 2h + k + 4 = 0 \\ h - 2k - 2 = 0 \end{cases} \Rightarrow h = -\frac{6}{5}, \quad k = -\frac{8}{5}.$$

This substitution yields

$$(2u + v)du + (u - 2v)dv = 0 \Rightarrow \frac{dv}{du} = \frac{v + 2u}{2v - u} = \frac{(v/u) + 2}{2(v/u) - 1}.$$

We now let  $z = v/u$  (so,  $v' = z + uz'$ ) and conclude that

$$\begin{aligned} z + u \frac{dz}{du} &= \frac{z + 2}{2z - 1} \Rightarrow u \frac{dz}{du} = \frac{z + 2}{2z - 1} - z = \frac{-2z^2 + 2z + 2}{2z - 1} \\ \Rightarrow \int \frac{(2z - 1)dz}{z^2 - z - 1} &= -2 \int \frac{du}{u} \\ \Rightarrow \ln |z^2 - z - 1| &= -2 \ln |u| + C_1 \Rightarrow \ln |u^2 z^2 - u^2 z - u^2| = C_1 \\ \Rightarrow \ln |v^2 - uv - u^2| &= C_1 \\ \Rightarrow \ln \left| \left(y + \frac{8}{5}\right)^2 - \left(y + \frac{8}{5}\right) \left(x + \frac{6}{5}\right) - \left(x + \frac{6}{5}\right)^2 \right| &= C_1 \\ \Rightarrow (5y + 8)^2 - (5y + 8)(5x + 6) - (5x + 6)^2 &= C, \end{aligned}$$

where  $C = \pm 25e^{C_1} \neq 0$  is any constant.

Separating variables, we lost two constant solutions  $z(u)$ , which are the zeros of the polynomial  $z^2 - z - 1$ . They can be included in the above formula by taking  $C = 0$ . Therefore, a general solution is given by

$$(5y + 8)^2 - (5y + 8)(5x + 6) - (5x + 6)^2 = C,$$

where  $C$  is an arbitrary constant.

- 34.** In Problem 2, we found that the given equation can be written as a Bernoulli equation,

$$\frac{dx}{dt} - \frac{1}{2t}x = -\frac{t}{2}x^{-1}.$$

Thus,

$$2x \frac{dx}{dt} - \frac{1}{t}x^2 = -t \Rightarrow (v = x^2) \quad \frac{dv}{dt} - \frac{1}{t}v = -t.$$

The latter is a linear equation, which has an integrating factor

$$\mu(t) = \exp\left(-\int \frac{dt}{t}\right) = \frac{1}{t}.$$

Thus,

$$\begin{aligned} v &= t \int (-1) dt = t(-t + C) = -t^2 + Ct \\ \Rightarrow \quad x^2 + t^2 - Ct &= 0, \end{aligned}$$

where  $C$  is an arbitrary constant. We also note that a constant solution,  $t \equiv 0$ , was lost in writing the given equation as a Bernoulli equation.

**36.** Dividing the equation by  $y^2$  yields

$$\begin{aligned} y^{-2} \frac{dy}{dx} + \frac{1}{x} y^{-1} &= x^3 \quad \Rightarrow \quad v = y^{-1}, \quad v' = -y^{-2} y' \\ \Rightarrow \quad -\frac{dv}{dx} + \frac{1}{x} v &= x^3 \quad \Rightarrow \quad \frac{dv}{dx} - \frac{1}{x} v = -x^3 \\ \Rightarrow \quad \mu(x) &= \exp\left(-\int \frac{dx}{x}\right) = \frac{1}{x} \\ \Rightarrow \quad v &= -x \int x^2 dx = -x \left(\frac{x^3}{3} + C_1\right) = -\frac{x^4 + Cx}{3}, \end{aligned}$$

where  $C = 3C_1$  is an arbitrary constant. Thus,

$$y = v^{-1} = -\frac{3}{x^4 + Cx}.$$

Together with the constant (lost) solution  $y \equiv 0$ , this gives a general solution to the original equation.

**38.** Since this equation is a Bernoulli equation (see Problem 6), we make a substitution  $v = y^{1/2}$  so that  $2v' = y^{-1/2} y'$  and obtain a linear equation

$$2 \frac{dv}{d\theta} - \frac{1}{\theta} v = \theta^{-1/2} \quad \Rightarrow \quad \frac{dv}{d\theta} - \frac{1}{2\theta} v = \frac{1}{2} \theta^{-1/2}.$$

An integrating factor for this equation is

$$\mu(\theta) = \exp\left(-\int \frac{d\theta}{2\theta}\right) = \theta^{-1/2}.$$

So,

$$v = \theta^{1/2} \int \left(\frac{1}{2} \theta^{-1/2} \theta^{-1/2}\right) d\theta = \frac{\theta^{1/2}}{2} (\ln |\theta| + C).$$

Therefore,

$$y = v^2 = \frac{\theta}{4} (\ln |\theta| + C)^2.$$

Dividing the given equation by  $\theta d\theta$ , we lost a constant solution  $\theta \equiv 0$ .



## Chapter 2

40. Using the conclusion made in Problem 8, we make a substitution  $v = x + y$ ,  $v' = 1 + y'$ , and obtain a separable equation

$$\frac{dv}{dx} = \tan v + 1 \quad \Rightarrow \quad \frac{dv}{\tan v + 1} = dx.$$

The integral of the left-hand side can be found, for instance, as follows.

$$\begin{aligned} \int \frac{dv}{\tan v + 1} &= \int \frac{\cos v \, dv}{\sin v + \cos v} = \frac{1}{2} \int \left( \frac{\cos v - \sin v}{\sin v + \cos v} + 1 \right) dv \\ &= \frac{1}{2} \left[ \int \frac{d(\sin v + \cos v)}{\sin v + \cos v} + \int dv \right] = \frac{1}{2} (\ln |\sin v + \cos v| + v). \end{aligned}$$

Therefore,

$$\begin{aligned} \frac{1}{2} (\ln |\sin v + \cos v| + v) &= x + C_1 \\ \Rightarrow \ln |\sin(x + y) + \cos(x + y)| + x + y &= 2x + C_2 \\ \Rightarrow \ln |\sin(x + y) + \cos(x + y)| &= x - y + C_2 \\ \Rightarrow \sin(x + y) + \cos(x + y) &= \pm e^{C_2} e^{x-y} = C e^{x-y}, \end{aligned}$$

where  $C \neq 0$  is an arbitrary constant. Note that in procedure of separating variables we lost solutions corresponding to

$$\tan v + 1 = 0 \quad \Rightarrow \quad x + y = v = -\frac{\pi}{4} + k\pi, \quad k = 0, \pm 1, \pm 2, \dots,$$

which can be included in the above formula by letting  $C = 0$ .

42. Suggested substitution,  $y = vx^2$  (so that  $y' = 2xv + x^2v'$ ), yields

$$2xv + x^2 \frac{dv}{dx} = 2vx + \cos v \quad \Rightarrow \quad x^2 \frac{dv}{dx} = \cos v.$$

Solving this separable equation, we obtain

$$\begin{aligned} \frac{dv}{\cos v} = \frac{dx}{x^2} &\quad \Rightarrow \quad \ln |\sec v + \tan v| = -x^{-1} + C_1 \\ \Rightarrow \sec v + \tan v &= \pm e^{C_1} e^{-1/x} = C e^{-1/x} \\ \Rightarrow \sec \left( \frac{y}{x^2} \right) + \tan \left( \frac{y}{x^2} \right) &= C e^{-1/x}, \end{aligned}$$

where  $C = \pm e^{C_1}$  is an arbitrary nonzero constant. With  $C = 0$ , this formula also includes lost solutions

$$y = \left[ \frac{\pi}{2} + (2k + 1)\pi \right] x^2, \quad k = 0, \pm 1, \pm 2, \dots$$

So, together with the other set of lost solutions,

$$y = \left(\frac{\pi}{2} + 2k\pi\right) x^2, \quad k = 0, \pm 1, \pm 2, \dots,$$

we get a general solution to the given equation.

44. From

$$\frac{dy}{dx} = -\frac{a_1x + b_1y + c_1}{a_2x + b_2y + c_2},$$

using that  $a_2 = ka_1$  and  $b_2 = kb_1$ , we obtain

$$\frac{dy}{dx} = -\frac{a_1x + b_1y + c_1}{ka_1x + kb_1y + c_2} = -\frac{a_1x + b_1y + c_1}{k(a_1x + b_1y) + c_2} = G(a_1x + b_1y),$$

where

$$G(t) = -\frac{t + c_1}{kt + c_2}.$$

46. (a) Substituting  $y = u + 1/v$  into the Riccati equation (18) and using the fact that  $u(x)$  is a solution, we obtain

$$\begin{aligned} \frac{d}{dx}(u + v^{-1}) &= P(x)(u + v^{-1})^2 + Q(x)(u + v^{-1}) + R(x) \\ \Leftrightarrow \frac{du}{dx} - v^{-2}\frac{dv}{dx} &= P(x)u^2 + 2P(x)u(x)v^{-1} + P(x)v^{-2} \\ &\quad + Q(x)u + Q(x)v^{-1} + R(x) \\ \Leftrightarrow \frac{du}{dx} - v^{-2}\frac{dv}{dx} &= [P(x)u^2 + Q(x)u + R(x)] \\ &\quad + [2P(x)u(x) + Q(x)]v^{-1} + P(x)v^{-2} \\ \Leftrightarrow -v^{-2}\frac{dv}{dx} &= [2P(x)u(x) + Q(x)]v^{-1} + P(x)v^{-2} \\ \Leftrightarrow \frac{dv}{dx} + [2P(x)u(x) + Q(x)]v &= -P(x), \end{aligned}$$

which is indeed a linear equation with respect to  $v$ .

(b) Writing

$$\frac{dy}{dx} = x^3y^2 + \left(-2x^4 + \frac{1}{x}\right)y + x^5$$

and using notations in (18), we see that  $P(x) = x^3$ ,  $Q(x) = (-2x^4 + 1/x)$ , and  $R(x) = x^5$ . So, using part (a), we are looking for other solutions to the given equation of the form  $y = x + 1/v$ , where  $v(x)$  satisfies

$$\frac{dv}{dx} + \left[2(x^3)x + \left(-2x^4 + \frac{1}{x}\right)\right]v = \frac{dv}{dx} + -\frac{1}{x}v = -x^3.$$

## Chapter 2

Since an integrating factor for this linear equation is

$$\mu(x) = \exp\left(\int \frac{dx}{x}\right) = x,$$

we obtain

$$v = x^{-1} \int (-x^4) dx = \frac{-x^5 + C}{5x} \quad \Rightarrow \quad \frac{1}{v} = \frac{5x}{C - x^5},$$

and so a general solution is given by

$$y = x + \frac{5x}{C - x^5}.$$

### REVIEW PROBLEMS

2.  $y = -8x^2 - 4x - 1 + Ce^{4x}$

4.  $\frac{x^3}{6} - \frac{4x^2}{5} + \frac{3x}{4} - Cx^{-3}$

6.  $y^{-2} = 2 \ln |1 - x^2| + C$  and  $y \equiv 0$

8.  $y = (Cx^2 - 2x^3)^{-1}$  and  $y \equiv 0$

10.  $x + y + 2y^{1/2} + \arctan(x + y) = C$

12.  $2ye^{2x} + y^3e^x = C$

14.  $x = \frac{t^2(t-1)}{2} + t(t-1) + 3(t-1) \ln |t-1| + C(t-1)$

16.  $y = \cos x \ln |\cos x| + C \cos x$

18.  $y = 1 - 2x + \sqrt{2} \tan(\sqrt{2}x + C)$

20.  $y = \left(C\theta^{-3} - \frac{12\theta^2}{5}\right)^{1/3}$

22.  $(3y - 2x + 9)(y + x - 2)^4 = C$

24.  $2\sqrt{xy} + \sin x - \cos y = C$

26.  $y = Ce^{-x^2/2}$

28.  $(y + 3)^2 + 2(y + 3)(x + 2) - (x + 2)^2 = C$

30.  $y = Ce^{4x} - x - \frac{1}{4}$

32.  $y^2 = x^2 \ln(x^2) + 16x^2$

34.  $y = x^2 \sin x + \frac{2x^2}{\pi^2}$

36.  $\sin(2x + y) - \frac{x^3}{3} + e^y = \sin 2 + \frac{2}{3}$

38.  $y = \left[ 2 - \left( \frac{1}{4} \right) \arctan \left( \frac{x}{2} \right) \right]^2$

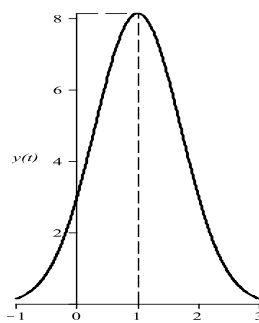
40.  $y = \frac{8}{1 - 3e^{-4x} - 4x}$

**TABLES**

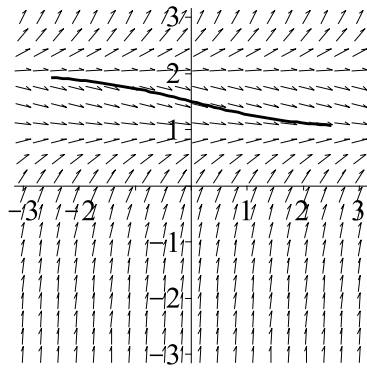
$n$	$x_n$	$y_n$	$n$	$x_n$	$y_n$
1	0.1	1.475	6	0.6	1.353368921
2	0.2	1.4500625	7	0.7	1.330518988
3	0.3	1.425311875	8	0.8	1.308391369
4	0.4	1.400869707	9	0.9	1.287062756
5	0.5	1.376852388	10	1.0	1.266596983

**Table 2–A:** Euler’s approximations to  $y' = x - y$ ,  $y(0) = 0$ , on  $[0, 1]$  with  $h = 0.1$ .

**FIGURES**

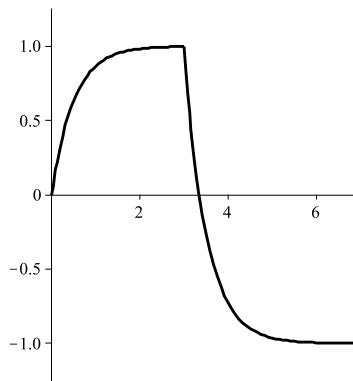


**Figure 2–A:** The graph of the solution in Problem 28.



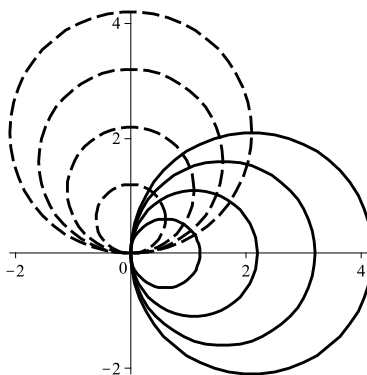
**Figure 2–B:** The direction field and solution curve in Problem 32.

---



**Figure 2–C:** The graph of the solution in Problem 32.

---



**Figure 2–D:** Curves and their orthogonal trajectories in Problem 34.

---

## CHAPTER 3: Mathematical Models and Numerical Methods Involving First Order Equations

### EXERCISES 3.2: Compartmental Analysis

2. Let  $x(t)$  denote the mass of salt in the tank at time  $t$  with  $t = 0$  denoting the moment when the process started. Thus we have  $x(0) = 0.5$  kg. We use the mathematical model described by equation (1) of the text to find  $x(t)$ . Since the solution is entering the tank with rate 6 L/min and contains 0.05 kg/L of salt,

$$\text{input rate} = 6 \text{ (L/min)} \cdot 0.05 \text{ (kg/L)} = 0.3 \text{ (kg/min)}.$$

We can determine the concentration of salt in the tank by dividing  $x(t)$  by the volume of the solution, which remains constant, 50 L, because the flow rate in is the same as the flow rate out. Therefore, the concentration of salt at time  $t$  is  $x(t)/50$  kg/L and

$$\text{output rate} = \frac{x(t)}{50} \text{ (kg/L)} \cdot 6 \text{ (L/min)} = \frac{3x(t)}{25} \text{ (kg/min)}.$$

Then the equation (1) yields

$$\frac{dx}{dt} = 0.3 - \frac{3x}{25} \quad \Rightarrow \quad \frac{dx}{dt} + \frac{3x}{25} = 0.3, \quad x(0) = 0.5.$$

This equation is linear, has integrating factor  $\mu(t) = \exp \left[ \int (3/25) dt \right] = e^{3t/25}$ , and so

$$\begin{aligned} \frac{d(e^{3t/25}x)}{dt} &= 0.3e^{3t/25} \\ \Rightarrow e^{3t/25}x &= 0.3 \left( \frac{25}{3} \right) e^{3t/25} + C = 2.5e^{3t/25} + C \quad \Rightarrow \quad x = 2.5 + Ce^{-3t/25}. \end{aligned}$$

Using the initial condition, we find  $C$ .

$$0.5 = x(0) = 2.5 + C \quad \Rightarrow \quad C = -2,$$

and so the mass of salt in the tank after  $t$  minutes is

$$x(t) = 2.5 - 2e^{-3t/25}.$$

## Chapter 3

If the concentration of salt in the tank is 0.03 kg/L, then the mass of salt there is  $0.03 \times 50 = 1.5$  kg, and we solve

$$2.5 - 2e^{-3t/25} = 1.5 \quad \Rightarrow \quad e^{-3t/25} = \frac{1}{2} \quad \Rightarrow \quad t = \frac{25 \ln 2}{3} \approx 5.8 \text{ (min)}.$$

4. Let  $x(t)$  denote the mass of salt in the tank at time  $t$ . Since at time  $t = 0$  the tank contained pure water, the initial condition is  $x(0) = 0$ . We use the mathematical model described by equation (1) of the text to find  $x(t)$ . Since the solution is entering the tank with rate 4 L/min and contains 0.2 kg/L of salt,

$$\text{input rate} = 4 \text{ (L/min)} \cdot 0.2 \text{ (kg/L)} = 0.8 \text{ (kg/min)}.$$

We can determine the concentration of salt in the tank by dividing  $x(t)$  by the volume  $v(t)$  of the solution at time  $t$ . Since 4 L enter the tank every minute but only 3 L flow out, the volume of the solution after  $t$  minutes is

$$v(t) = v(0) + (4 - 3)t = 100 + t \text{ (L)}.$$

Therefore, the concentration of salt at time  $t$  is  $x(t)/v(t) = x(t)/(100 + t)$  kg/L and

$$\text{output rate} = \frac{x(t)}{100 + t} \text{ (kg/L)} \cdot 3 \text{ (L/min)} = \frac{3x(t)}{100 + t} \text{ (kg/min)}.$$

Then the equation (1) yields

$$\frac{dx}{dt} = 0.8 - \frac{3x}{100 + t} \quad \Rightarrow \quad \frac{dx}{dt} + \frac{3x}{100 + t} = 0.8, \quad x(0) = 0.$$

This equation is linear, has integrating factor

$$\mu(t) = \exp\left(\int \frac{3dt}{100 + t}\right) = (100 + t)^3,$$

and so

$$\begin{aligned} \frac{d((100 + t)^3 x)}{dt} &= 0.8(100 + t)^3 \\ \Rightarrow (100 + t)^3 x &= 0.2(100 + t)^4 + C \quad \Rightarrow \quad x = 0.2(100 + t) + C(100 + t)^{-3}. \end{aligned}$$

Using the initial condition, we find  $C$ .

$$0 = x(0) = 20 + C \cdot 10^{-6} \quad \Rightarrow \quad C = -2 \cdot 10^7,$$

and so the mass of salt in the tank after  $t$  minutes is

$$x = 0.2(100 + t) - 2 \cdot 10^7(100 + t)^{-3}.$$

To answer the second question, we solve

$$\begin{aligned} \frac{x(t)}{v(t)} &= 0.2 - 2 \cdot 10^7(100 + t)^{-4} = 0.1 &\Rightarrow & (100 + t)^4 = 2 \cdot 10^8 \\ \Rightarrow & t = \sqrt[4]{2 \cdot 10^8} - 100 = 100 \left( \sqrt[4]{2} - 1 \right) \approx 19 \text{ (min)}. \end{aligned}$$

6. The volume  $V$  of the room is

$$V = 12 \times 8 \times 8 = 768 \text{ ft}^3.$$

Let  $v(t)$  denote the amount of carbon monoxide in the room at time  $t$ . Since, at  $t = 0$ , the room contained 3% of carbon monoxide, we have an initial condition

$$v(0) = 768 \cdot 0.03 = 23.04.$$

The input rate in this problem is zero, because incoming air does not contain carbon monoxide. Next, the output rate can be found as the concentration at time  $t$  multiplied by the rate of outgoing flow, which is  $100 \text{ ft}^3/\text{min}$ . Thus,

$$\text{output rate} = \frac{v(t)}{V} \cdot 100 = \frac{100v(t)}{768} = \frac{25v(t)}{192},$$

and the equation (1) of the text yields

$$\frac{dv}{dt} = -\frac{25v}{192}, \quad v(0) = 23.04.$$

This is the exponential model (10), and so we can use formula (11) for the solution to this initial value problem.

$$v(t) = 23.04e^{-(25/192)t}.$$

The air in the room will be 0.01% carbon monoxide when

$$\frac{v(t)}{V} = 10^{-4} \quad \Rightarrow \quad \frac{23.04e^{-(25/192)t}}{768} = 10^{-4} \quad \Rightarrow \quad t = \frac{192 \ln 300}{25} \approx 43.8 \text{ (min)}.$$

8. Let  $s(t)$ ,  $t \geq 0$ , denote the amount of salt in the tank at time  $t$ . Thus we have  $s(0) = s_0$  lb.

We again use the mathematical model

$$\text{rate of change} = \text{input rate} - \text{output rate} \tag{3.1}$$



## Chapter 3

to find  $s(t)$ . Here

$$\text{input rate} = 4 \text{ (gal/min)} \cdot 0.5 \text{ (lb/gal)} = 2 \text{ (lb/min)}.$$

Since the flow rate in is the same as the flow rate out, the volume of the solution remains constant (200 gal), we have

$$c(t) = \frac{s(t)}{200} \text{ (lb/gal)}$$

and so

$$\text{output rate} = 4 \text{ (gal/min)} \cdot \frac{s(t)}{200} \text{ (lb/gal)} = \frac{s(t)}{50} \text{ (lb/min)}.$$

Then (3.1) yields

$$\frac{ds}{dt} = 2 - \frac{s}{50} \quad \Rightarrow \quad \frac{ds}{dt} + \frac{s}{50} = 2.$$

This equation is linear, has integrating factor  $\mu(t) = \exp \left[ \int (1/50) dt \right] = e^{t/50}$ . Integrating, we get

$$\frac{d(e^{t/50}s)}{dt} = 2e^{t/50} \quad \Rightarrow \quad s = 100 + Ce^{-t/50} \quad \Rightarrow \quad c(t) = \frac{1}{2} + (C/200)e^{-t/50},$$

where the constant  $C$  depends on  $s_0$ . (We do not need an explicit formula.) Taking the limit yields

$$\lim_{t \rightarrow \infty} c(t) = \lim_{t \rightarrow \infty} \left[ \frac{1}{2} + (C/200)e^{-t/50} \right] = \frac{1}{2}.$$

- 10.** In this problem, the dependent variable is  $x$ , the independent variable is  $t$ , and the function  $f(t, x) = a - bx$ . Since  $f(t, x) = f(x)$ , i.e., does not depend on  $t$ , the equation is autonomous. To find equilibrium solutions, we solve

$$f(x) = 0 \quad \Rightarrow \quad a - bx = 0 \quad \Rightarrow \quad x = \frac{a}{b}.$$

Thus,  $x(t) \equiv a/b$  is an equilibrium solution. For  $x < a/b$ ,  $x' = f(x) > 0$  meaning that  $x$  increases, while  $x' = f(x) < 0$  when  $x > a/b$  and so  $x$  decreases. Therefore, the phase line for the given equation is as it is shown in Fig. **3-A** on page 100. From this picture, we conclude that the equilibrium  $x = a/b$  is a sink. Thus, regardless of an initial point  $x_0$ , the solution to the corresponding initial value problem will approach  $x = a/b$ , as  $t \rightarrow \infty$ .

- 12.** Equating expressions (21) evaluated at times  $t_a$  and  $t_b = 2t_a$  yields

$$\frac{p_a p_1 e^{-A p_1 t_a}}{p_1 - p_a (1 - e^{-A p_1 t_a})} = \frac{p_b p_1 e^{-2A p_1 t_a}}{p_1 - p_b (1 - e^{-2A p_1 t_a})}.$$

With  $\chi = e^{-Ap_1 t_a}$ , this equation becomes

$$\begin{aligned} \frac{p_a p_1 \chi}{p_1 - p_a(1 - \chi)} &= \frac{p_b p_1 \chi^2}{p_1 - p_b(1 - \chi^2)} \\ \Rightarrow p_a p_1 (p_1 - p_b) \chi + p_a p_b p_1 \chi^3 &= p_b p_1 (p_1 - p_a) \chi^2 + p_a p_b p_1 \chi^3 \\ \Rightarrow p_1 \chi [p_a (p_1 - p_b) - p_b (p_1 - p_a) \chi] &= 0 \quad \Rightarrow \quad \chi = \frac{p_a (p_1 - p_b)}{p_b (p_1 - p_a)}. \end{aligned}$$

Hence, with  $t = t_a$ , expression (21) yields

$$\begin{aligned} p_0 &= \frac{p_a p_1 [p_a (p_1 - p_b)] / [p_b (p_1 - p_a)]}{p_1 - p_a + p_a [p_a (p_1 - p_b)] / [p_b (p_1 - p_a)]} \\ \Rightarrow p_0 &= \frac{p_a^2 p_1 (p_1 - p_b)}{p_b (p_1 - p_a)^2 + p_a^2 (p_1 - p_b)} = \frac{p_a^2 (p_1 - p_b)}{p_b p_1 - 2p_a p_b + p_a^2} \\ \Rightarrow p_1 (p_0 p_b - p_a^2) &= p_a (2p_0 p_b - p_0 p_a - p_a p_b) \\ \Rightarrow p_1 &= \frac{p_a (p_a p_b - 2p_0 p_b + p_0 p_a)}{p_a^2 - p_0 p_b}, \end{aligned}$$

and the formula for  $p_1$  is proved.

For the second formula, using the expression for  $\chi$ , we conclude that

$$\begin{aligned} \chi &= e^{-Ap_1 t_a} = \frac{p_a (p_1 - p_b)}{p_b (p_1 - p_a)} \\ \Rightarrow A &= \frac{1}{p_1 t_a} \ln \frac{1}{\chi} = \frac{1}{p_1 t_a} \ln \frac{p_b (p_1 - p_a)}{p_a (p_1 - p_b)}. \end{aligned}$$

Since

$$\begin{aligned} p_1 - p_a &= p_a \left[ \frac{p_a p_b - 2p_0 p_b + p_0 p_a}{p_a^2 - p_0 p_b} - 1 \right] \\ &= p_a \frac{p_a p_b - p_0 p_b + p_0 p_a - p_a^2}{p_a^2 - p_0 p_b} = \frac{p_a (p_b - p_a) (p_a - p_0)}{p_a^2 - p_0 p_b} \\ p_1 - p_b &= \frac{p_a (p_a p_b - 2p_0 p_b + p_0 p_a)}{p_a^2 - p_0 p_b} - p_b \\ &= \frac{p_0 p_a^2 - 2p_0 p_a p_b + p_0 p_b^2}{p_a^2 - p_0 p_b} = \frac{p_0 (p_b - p_a)^2}{p_a^2 - p_0 p_b}, \end{aligned}$$

we have

$$\frac{p_b (p_1 - p_a)}{p_a (p_1 - p_b)} = \frac{p_b}{p_a} \cdot \frac{p_a (p_a - p_0)}{p_0 (p_b - p_a)} = \frac{p_b (p_a - p_0)}{p_0 (p_b - p_a)},$$

and the formula for  $A$  is proved.

14. Counting time from the year 1970, we have an initial condition  $p(0) = 300$  for the population of alligators. Thus, the formula (11) yields

$$p(t) = 300e^{kt}.$$

## Chapter 3

In the year 1980,  $t = 10$  and, therefore,

$$p(10) = 300e^{k(10)} = 1500 \quad \Rightarrow \quad k = \frac{\ln 5}{10} \quad \Rightarrow \quad p(t) = 300e^{(t \ln 5)/10}.$$

In the year 2010,  $t = 2010 - 1970 = 40$ , and the estimated population of alligators, according to the Malthusian law, is

$$p(40) = 300e^{(40 \ln 5)/10} = 300 \cdot 5^4 = 187500.$$

**16.** By definition,

$$p'(t) = \lim_{h \rightarrow 0} \frac{p(t+h) - p(t)}{h}.$$

Replacing  $h$  by  $-h$  in the above equation, we obtain

$$p'(t) = \lim_{h \rightarrow 0} \frac{p(t-h) - p(t)}{-h} = \lim_{h \rightarrow 0} \frac{p(t) - p(t-h)}{h}.$$

Adding the previous two equations together yields

$$\begin{aligned} 2p'(t) &= \lim_{h \rightarrow 0} \left[ \frac{p(t+h) - p(t)}{h} + \frac{p(t) - p(t-h)}{h} \right] \\ &= \lim_{h \rightarrow 0} \left[ \frac{p(t+h) - p(t-h)}{h} \right]. \end{aligned}$$

Thus

$$p'(t) = \lim_{h \rightarrow 0} \left[ \frac{p(t+h) - p(t-h)}{2h} \right].$$

**18.** Setting  $t = 0$  for the year 2000, we obtain

$$t_a = 1920 - 1900 = 20, \quad t_b = 1940 - 1900 = 40.$$

Thus,  $t_b = 2t_a$ , and so we can use formulas given in Problem 12 to find  $p_1$  and  $A$ . With

$$p_0 = 76.21, \quad p_a = 106.02, \quad p_b = 132.16,$$

these formulas give

$$\begin{aligned} p_1 &= \left[ \frac{p_a p_b - 2p_0 p_b + p_0 p_a}{p_a^2 - p_0 p_b} \right] p_a \approx 176.73, \\ A &= \frac{1}{p_1 t_a} \ln \left[ \frac{p_b (p_a - p_0)}{p_0 (p_b - p_a)} \right] \approx 0.0001929. \end{aligned}$$

We can now use the logistic equation (15).

In 1990,  $t = 90$  and computations give  $p(90) \approx 166.52$ .

In 2000,  $t = 100$  and  $p(100) \approx 169.35$ .

The census data presented in Table 3.1 are 248.71 and 281.42, respectively.

20. Assuming that only dust clouds affect the intensity of the light, we conclude that the intensity of the light halved after passing the dust cloud.

Let  $s$  denote the distance (in light-years), and let  $I(s)$  be the intensity of the light after passing  $s$  light-years in the dust cloud. Using the given conditions, we then obtain an initial value problem

$$\frac{dI}{ds} = -0.1I, \quad I(0) = I_0.$$

Using the formula (11), we find that

$$I(s) = I_0 e^{-0.1s}.$$

If the thickness of the dust cloud is  $s^*$ , then

$$I(s^*) = I_0 e^{-0.1s^*} = (1/2)I_0 \quad \Rightarrow \quad s^* = 10 \ln 2 \approx 6.93.$$

Thus, the thickness of the dust cloud is approximately 6.93 light-years.

22. Let  $D(t)$  and  $S(t)$  denote the diameter and the surface area of the snowball at time  $t$ , respectively. From geometry, we know that  $S = \pi D^2$ . Since we are given that  $D'(t)$  is proportional to  $S(t)$ , the equation describing the melting process is

$$\begin{aligned} \frac{dD}{dt} = kS &\quad \Rightarrow \quad \frac{dD}{dt} = k(\pi D^2) &\quad \Rightarrow \quad \frac{dD}{D^2} = k\pi dt \\ \Rightarrow \quad -D^{-1} = k\pi t + C &\quad \Rightarrow \quad D = -\frac{1}{k\pi t + C}. \end{aligned}$$

Initially,  $D(0) = 4$ , and we also know that  $D(30) = 3$ . This yields a system

$$\begin{aligned} 4 = D(0) = -\frac{1}{C} &\quad \Rightarrow \quad C = -\frac{1}{4}; \\ 3 = D(30) = -\frac{1}{30k\pi + C} &\quad \Rightarrow \quad 30k\pi + C = -\frac{1}{3} \quad \Rightarrow \quad k\pi = -\frac{1}{360}. \end{aligned}$$

Thus,

$$D(t) = -\frac{1}{(-1/360)t - (1/4)} = \frac{360}{t + 90}.$$

The diameter  $D(t)$  of the snowball will be 2 inches when

$$\frac{360}{t + 90} = 2 \quad \Rightarrow \quad t = 90 \text{ (min)},$$

and, mathematically speaking, the snowball will melt infinitely long, but will never disappear, because  $D(t)$  is a strictly decreasing approaching zero, as  $t \rightarrow \infty$ .

## Chapter 3

- 24.** If  $m(t)$  (with  $t$  measured in years) denotes the mass of the radioactive substance, the law of decay says that

$$\frac{dm}{dt} = km(t),$$

with the decay constant  $k$  depending on the substance. If the initial mass of the substance is  $m(0) = m_0$ , then the formula (11) of the text yields

$$m(t) = m_0 e^{kt}.$$

In this problem,  $m_0 = 300$  g, and we know that  $m(5) = 200$  g. These data yield

$$200 = m(5) = 300 \cdot e^{k(5)} \quad \Rightarrow \quad k = \frac{\ln(2/3)}{5},$$

and so the decay is governed by the equation

$$m(t) = 300e^{[t \ln(2/3)]/5} = 300 \left(\frac{2}{3}\right)^{t/5}.$$

If only 10 g of the substance remain, then

$$300 \left(\frac{2}{3}\right)^{t/5} = 10 \quad \Rightarrow \quad t = \frac{5 \ln(30)}{\ln(3/2)} \approx 41.94 \text{ (yrs).}$$

- 26. (a)** Let  $M(t)$  denote the mass of carbon-14 present in the burnt wood of the campfire. Since carbon-14 decays at a rate proportional to its mass, we have

$$\frac{dM}{dt} = -\alpha M,$$

where  $\alpha$  is the proportionality constant. This equation is linear and separable. Using the initial condition,  $M(0) = M_0$ , from (11) we obtain

$$M(t) = M_0 e^{-\alpha t}.$$

Given the half-life of carbon-14 to be 5550 years, we find  $\alpha$  from

$$\frac{1}{2} M_0 = M_0 e^{-\alpha(5550)} \quad \Rightarrow \quad \frac{1}{2} = e^{-\alpha(5550)} \quad \Rightarrow \quad \alpha = \frac{\ln(0.5)}{-5550} \approx 0.00012489.$$

Thus,

$$M(t) = M_0 e^{-0.00012489t}.$$

Now we are told that after  $t$  years 2% of the original amount of carbon-14 remains in the campfire and we are asked to determine  $t$ . Thus

$$\begin{aligned} 0.02M_0 &= M_0 e^{-0.00012489t} & \Rightarrow & \quad 0.02 = e^{-0.00012489t} \\ \Rightarrow & \quad t = \frac{\ln 0.02}{-0.00012489} \approx 31323.75 \text{ (years)}. \end{aligned}$$

- (b) We repeat the arguments from part (a), but use the half-life 5600 years given in Problem 21 instead of 5550 years, to find that

$$\frac{1}{2}M_0 = M_0e^{-\alpha(5600)} \quad \Rightarrow \quad \frac{1}{2} = e^{-\alpha(5600)} \quad \Rightarrow \quad \alpha = \frac{\ln(0.5)}{-5600} \approx 0.00012378,$$

and so the decay is governed by

$$M(t) = M_0e^{-0.00012378t}.$$

Therefore, 3% of the original amount of carbon-14 remains in the campfire when  $t$  satisfies

$$\begin{aligned} 0.03M_0 &= M_0e^{-0.00012378t} & \Rightarrow & \quad 0.03 = e^{-0.00012378t} \\ \Rightarrow \quad t &= \frac{\ln 0.03}{-0.00012378} \approx 28328.95 \text{ (years)}. \end{aligned}$$

- (c) Comparing the results obtained in parts (a) and (b) with the answer to Problem 21, that is, 31606 years, we conclude that the model is more sensitive to the percent of the mass remaining.

### EXERCISES 3.3: Heating and Cooling of Buildings

2. Let  $T(t)$  denote the temperature of the beer at time  $t$  (in minutes). According to the Newton's law of cooling (see (1)),

$$\frac{dT}{dt} = K[70 - T(t)],$$

where we have taken  $H(t) \equiv U(t) \equiv 0$  and  $M(t) \equiv 70^\circ\text{F}$ , with the initial condition  $T(0) = 35^\circ\text{C}$ . Solving this initial value problem yields

$$\begin{aligned} \frac{dT}{T-70} = -K dt & \Rightarrow \ln|T-70| = -Kt + C_1 & \Rightarrow T(t) = 70 - Ce^{-Kt}; \\ 35 = T(0) = 70 - Ce^{-K(0)} & \Rightarrow C = 35 & \Rightarrow T(t) = 70 - 35e^{-Kt}. \end{aligned}$$

To find  $K$ , we use the fact that after 3 min the temperature of the beer was  $40^\circ\text{F}$ . Thus,

$$40 = T(3) = 70 - 35e^{-K(3)} \quad \Rightarrow \quad K = \frac{\ln(7/6)}{3},$$

and so

$$T(t) = 70 - 35e^{-\ln(7/6)t/3} = 70 - 35\left(\frac{6}{7}\right)^{t/3}.$$

## Chapter 3

Finally, after 20 min, the temperature of the beer will be

$$T(20) = 70 - 35 \left(\frac{6}{7}\right)^{20/3} \approx 57.5 \text{ (F}^\circ\text{)}.$$

4. Let  $T(t)$  denote the temperature of the wine at time  $t$  (in minutes). According to the Newton's law of cooling,

$$\frac{dT}{dt} = K[23 - T(t)],$$

where we have taken the outside (room's) temperature  $M(t) \equiv 23^\circ\text{C}$ , with the initial condition  $T(0) = 10^\circ\text{C}$ . Solving this initial value problem yields

$$\begin{aligned} \frac{dT}{T - 23} = -K dt &\Rightarrow \ln|T - 23| = -Kt + C_1 \Rightarrow T(t) = 23 - Ce^{-Kt}; \\ 10 = T(0) = 23 - Ce^{-K(0)} &\Rightarrow C = 13 \Rightarrow T(t) = 23 - 13e^{-Kt}. \end{aligned}$$

To find  $K$ , we use the fact that after 10 min the temperature of the wine was  $15^\circ\text{C}$ . Thus,

$$15 = T(10) = 23 - 13e^{-K(10)} \Rightarrow K = \frac{\ln(13/8)}{10},$$

and so

$$T(t) = 23 - 13e^{-\ln(13/8)t/10} = 23 - 13 \left(\frac{8}{13}\right)^{t/10}.$$

We now solve the equation  $T(t) = 18$ .

$$18 = 23 - 13 \left(\frac{8}{13}\right)^{t/10} \Rightarrow \left(\frac{8}{13}\right)^{t/10} = \frac{5}{13} \Rightarrow t = \frac{10 \ln(5/13)}{\ln(8/13)} \approx 19.7 \text{ (min)}.$$

6. The temperature function  $T(t)$  changes according to Newton's law of cooling. Similarly to Example 1, we conclude that, with  $H(t) = U(t) \equiv 0$  and the outside temperature  $M(t) \equiv 12^\circ\text{C}$ , a general solution formula (4) yields

$$T(t) = 12 + Ce^{-Kt}.$$

To find  $C$ , we use the initial condition,

$$T(0) = T(\text{at noon}) = 21^\circ\text{C},$$

and get

$$21 = T(0) = 12 + Ce^{-K(0)} \Rightarrow C = 21 - 12 = 9 \Rightarrow T(t) = 12 + 9e^{-Kt}.$$

## Exercises 3.3

The time constant for the building is  $1/K = 3$  hr; so  $K = 1/3$  and  $T(t) = 12 + 9e^{-t/3}$ .

We now solve the equation

$$T(t) = 12 + 9e^{-t/3} = 16$$

to find the time when the temperature inside the building reaches  $16^\circ\text{C}$ .

$$12 + 9e^{-t/3} = 16 \quad \Rightarrow \quad t = 3 \ln \left( \frac{9}{4} \right) \approx 2.43 \text{ (hr)}.$$

Thus, the temperature inside the building will be  $16^\circ\text{C}$  at 2.43 hours after noon, that is, approximately at 2:26 P.M.

Similarly, with the time constant  $1/K = 2$ , we get

$$T(t) = 12 + 9e^{-t/2} \quad \Rightarrow \quad 12 + 9e^{-t/2} = 16 \quad \Rightarrow \quad t = 2 \ln \left( \frac{9}{4} \right) \approx 1.62 \text{ (hr)}$$

or 12:37 P.M.

8. Setting  $t = 0$  at 2:00 A.M., for the outside temperature  $M(t)$  we have

$$M(t) = 65 - 15 \cos \left( \frac{\pi t}{12} \right)$$

so that a general solution (4) (with  $K = 1/2$ ,  $H(t) \equiv U(t) \equiv 0$ ) becomes

$$\begin{aligned} T(t) &= e^{-t/2} \left\{ \frac{1}{2} \int e^{t/2} \left[ 65 - 15 \cos \left( \frac{\pi t}{12} \right) \right] dt + C \right\} \\ &= 65 - \frac{540}{36 + \pi^2} \cos \left( \frac{\pi t}{12} \right) - \frac{90\pi}{36 + \pi^2} \sin \left( \frac{\pi t}{12} \right) + Ce^{-t/2}. \end{aligned}$$

Neglecting the exponential term, which will become insignificant with time (say, next day), we obtain

$$T(t) \approx \tilde{T}(t) = 65 - \frac{540}{36 + \pi^2} \cos \left( \frac{\pi t}{12} \right) - \frac{90\pi}{36 + \pi^2} \sin \left( \frac{\pi t}{12} \right).$$

Solving  $\tilde{T}'(t) = 0$  on  $[0, 24)$  gives

$$\begin{aligned} \frac{540}{36 + \pi^2} \sin \left( \frac{\pi t}{12} \right) - \frac{90\pi}{36 + \pi^2} \cos \left( \frac{\pi t}{12} \right) &= 0 \quad \Rightarrow \quad \tan \left( \frac{\pi t}{12} \right) = \frac{\pi}{6} \\ \Rightarrow \quad t_{\min} = \frac{12}{\pi} \arctan \left( \frac{\pi}{6} \right) &\approx 1.84 \text{ (h)}, \quad t_{\max} = t_{\min} + 12 \approx 13.84 \text{ (h)}. \end{aligned}$$

Therefore, the lowest temperature of  $T(t_{\min}) \approx 51.7^\circ\text{F}$  will be reached 1.84 (h) after 2:00 A.M., that is, at approximately 3:50 A.M.

The highest temperature of  $T(t_{\max}) \approx 78.3^\circ\text{F}$  will be 12 hours later, i.e., at 3:50 P.M.



## Chapter 3

- 10.** In this problem, we use the equation (9) from the text with the following values of parameters.

$$\begin{aligned}K &= 0.5, \\M(t) &\equiv 40 \text{ (}^\circ\text{F)}, \\H(t) &\equiv 0, \\K_U &= K_1 - K = 2 - 0.5 = 1.5, \\T_D &= 70 \text{ (}^\circ\text{F)}.\end{aligned}$$

Thus, we have

$$\frac{dT}{dt} = 0.5(40 - T) + 1.5(70 - T) = 125 - 2T.$$

Solving this linear equation yields

$$T(t) = e^{-2t} \left[ \int (125)e^{2t} dt + C \right] = 62.5 + Ce^{-2t}.$$

Setting  $t = 0$  at 7 : 00 A.M., we find that

$$T(0) = 62.5 + C = 40 \quad \Rightarrow \quad C = -22.5 \quad \Rightarrow \quad T(t) = 62.5 - 22.5e^{-2t}.$$

At 8:00 A.M.,  $t = 1$  so that

$$T(1) = 62.5 - 22.5e^{-2} \approx 59.5 \text{ (}^\circ\text{F)}.$$

Since  $T(t)$  is an increasing function with

$$\lim_{t \rightarrow \infty} T(t) = 62.5,$$

the temperature in the lecture hall will never reach  $65^\circ\text{F}$ .

- 12.** We let  $T_1(t)$  and  $T_2(t)$  denote the temperature of the coffee of the impatient friend and the relaxed friend, respectively, with  $t = 0$  meaning the time when the coffee was served. Both functions satisfy the Newton's law (1) of cooling with  $H(t) \equiv U(t) \equiv 0$  and the air temperature  $M(t) \equiv M_0 = \text{const}$ . Therefore, by (4), we have

$$T_k(t) = M_0 + C_k e^{-Kt}, \quad k = 1, 2. \quad (3.2)$$

The constants  $C_k$  depend on the initial temperatures of the coffee. Let's assume that the temperature of the coffee when served was  $T_0$ , the amount of the coffee ordered was

### Exercises 3.3

$V_0$ , the temperature of the cream was  $T_c$ , and the teaspoon used had the capacity of  $V_c$ . With this assumptions, we have the initial conditions

$$T_2(0) = T_0, \quad T_1(0) = \frac{T_0V_0 + T_cV_c}{V_0 + V_c}$$

(since the impatient friend immediately added a teaspoon of cream). Substituting these initial conditions into (3.2) yields

$$C_1 = \frac{T_0V_0 + T_cV_c}{V_0 + V_c} - M_0, \quad C_2 = T_0 - M_0.$$

Hence,

$$\begin{aligned} T_1(t) &= M_0 + \left( \frac{T_0V_0 + T_cV_c}{V_0 + V_c} - M_0 \right) e^{-Kt} = M_0 + \frac{(T_0V_0 + T_cV_c) - M_0(V_0 + V_c)}{V_0 + V_c} e^{-Kt}, \\ T_2(t) &= M_0 + (T_0 - M_0) e^{-Kt}, \end{aligned}$$

and so, after 5 min, the temperatures were

$$\begin{aligned} T_1(5) &= M_0 + \frac{(T_0V_0 + T_cV_c) - M_0(V_0 + V_c)}{V_0 + V_c} e^{-5K}, \\ T_2(5) &= M_0 + (T_0 - M_0) e^{-5K}. \end{aligned}$$

At this same instant of time, the second (relaxed) friend had added a teaspoon of cream reducing his coffee's temperature to

$$\tilde{T}_2(5) = \frac{T_2(5)V_0 + T_cV_c}{V_0 + V_c} = \frac{[M_0 + (T_0 - M_0) e^{-5K}] V_0 + T_cV_c}{V_0 + V_c}.$$

We now compare  $T_1(5)$  and  $\tilde{T}_2(5)$ .

$$T_1(5) - \tilde{T}_2(5) = (V_0 + V_c)^{-1} V_c (M_0 - T_c) (1 - e^{-5K}) > 0,$$

because we assume that the cream is cooler than the air, i.e.,  $T_c < M_0$ . Thus, the impatient friend had the hotter coffee.

14. Since the time constant is now 72, we have  $K = 1/72$ . The temperature in the new tank increases at the rate of  $1^\circ\text{F}$  for every 1000 Btu. Furthermore, every hour of sunlight provides an input of 2000 Btu to the tank. Thus,

$$H(t) = 1 \times 2 = 2 \text{ } (^\circ\text{F/h}).$$

## Chapter 3

We are given that  $T(0) = 110$ , and that the temperature  $M(t)$  outside the tank is constantly  $80^\circ\text{F}$ . Hence, the temperature in the tank is governed by

$$\frac{dT}{dt} = \frac{1}{72} [80 - T(t)] + 2 = -\frac{1}{72} T(t) + \frac{28}{9}, \quad T(0) = 110.$$

Solving this separable equation gives

$$T(t) = 224 - Ce^{-t/72}.$$

To find  $C$ , we use the initial condition and find that

$$T(0) = 110 = 224 - C \quad \Rightarrow \quad C = 114.$$

This yields

$$T(t) = 224 - 114e^{-t/72}.$$

So, after 12 hours of sunlight, the temperature will be

$$T(12) = 224 - 114e^{-12/72} \approx 127.5 \text{ (}^\circ\text{F)}.$$

**16.** Let  $A := \sqrt{C_1^2 + C_2^2}$ . Then

$$\begin{aligned} C_1 \cos \omega t + C_2 \sin \omega t &= A \left( \frac{C_1}{\sqrt{C_1^2 + C_2^2}} \cos \omega t + \frac{C_2}{\sqrt{C_1^2 + C_2^2}} \sin \omega t \right) \\ &= A (\alpha_1 \cos \omega t + \alpha_2 \sin \omega t). \end{aligned} \quad (3.3)$$

We note that

$$\alpha_1^2 + \alpha_2^2 = \left( \frac{C_1}{\sqrt{C_1^2 + C_2^2}} \right)^2 + \left( \frac{C_2}{\sqrt{C_1^2 + C_2^2}} \right)^2 = 1.$$

Therefore,  $\alpha_1$  and  $\alpha_2$  are the values of the cosine and sine functions of an angle  $\phi$ , namely, the angle satisfying

$$\cos \phi = \alpha_1, \quad \sin \phi = \alpha_2 \quad \Rightarrow \quad \tan \phi = \frac{\alpha_2}{\alpha_1} = \frac{C_2}{C_1}. \quad (3.4)$$

Hence, (3.3) becomes

$$C_1 \cos \omega t + C_2 \sin \omega t = A (\cos \phi \cos \omega t + \sin \phi \sin \omega t) = A \cos (\omega t - \phi). \quad (3.5)$$

In the equation (7) of the text,

$$F(t) = \frac{\cos \omega t + (\omega/K) \sin \omega t}{1 + (\omega/K)^2} = C_1 \cos \omega t + C_2 \sin \omega t$$

with

$$C_1 = \frac{1}{1 + (\omega/K)^2}, \quad C_2 = \frac{(\omega/K)}{1 + (\omega/K)^2}$$

$$\Rightarrow A = \sqrt{\left(\frac{1}{1 + (\omega/K)^2}\right)^2 + \left(\frac{(\omega/K)}{1 + (\omega/K)^2}\right)^2} = (1 + (\omega/K)^2)^{-1/2}.$$

Thus, (3.4) and (3.5) give us

$$F(t) = (1 + (\omega/K)^2)^{-1/2} \cos(\omega t - \phi), \quad \text{where} \quad \tan \phi = \frac{\omega}{K}.$$

### EXERCISES 3.4: Newtonian Mechanics

2. This problem is a particular case of Example 1 of the text. Therefore, we can use the general formula (6) with

$$m = \frac{400}{g} = \frac{400}{32} = 12.5 \text{ (slugs)},$$

$b = 10$ , and  $v_0 = v(0) = 0$ . But let us follow the general idea of Section 3.4, find an equation of the motion, and solve it.

With given data, the force due to gravity is  $F_1 = mg = 400$  lb and the air resistance force is  $F_2 = -10v$  lb. Therefore, the velocity  $v(t)$  satisfies

$$12.5 \frac{dv}{dt} = F_1 + F_2 = 400 - 10v \quad \Rightarrow \quad \frac{dv}{dt} = 32 - 0.8v, \quad v(0) = 0.$$

Separating variables and integrating yields

$$\frac{dv}{0.8v - 32} = -dt \quad \Rightarrow \quad \ln |0.8v - 32| = -0.8t + C_1$$

$$\Rightarrow \quad 0.8v - 32 = \pm e^{C_1} e^{-0.8t} = C_2 e^{-0.8t} \quad \Rightarrow \quad v(t) = 40 + C e^{-0.8t}.$$

Substituting the initial condition,  $v(0) = 0$ , we get  $C = -40$ , and so

$$v(t) = 40 (1 - e^{-0.8t}).$$

Integrating this equation yields

$$x(t) = \int v(t) dt = 40 \int (1 - e^{-0.8t}) dt = 40t + 50e^{-0.8t} + C,$$

and we find that  $C = -50$  by using the initial condition,  $x(0) = 0$ . Therefore,

$$x(t) = 40t + 50e^{-0.8t} - 50 \text{ (ft)}.$$

## Chapter 3

When the object hits the ground,  $x(t) = 500$  ft. Thus we solve

$$x(t) = 40t + 50e^{-0.8t} - 50 = 500.$$

Since  $x(13) < 500$  and  $x(14) > 500$  a (*positive*) solution  $t \in [13, 14]$ . On this interval,  $e^{-0.8t}$  is very small, so we simply ignore it and solve

$$40t - 50 = 500 \quad \Rightarrow \quad t = 13.75 \text{ (sec)}.$$

4. Using the equation of the motion of the object found in Problem 2, we solve the equation

$$40t + 50e^{-0.8t} - 50 = 30 \quad \Rightarrow \quad 40t + 50e^{-0.8t} - 80 = 0.$$

This time, the solution belongs to  $[1, 2]$  and, therefore, we cannot ignore the exponential term. Thus, we use Newton's method (see Appendix A in the text) to approximate the solution. We apply the recursive formula

$$t_{n+1} = t_n - \frac{g(t_n)}{g'(t_n)}$$

with

$$g(t) = 40t + 50e^{-0.8t} - 80 \quad \Rightarrow \quad g'(t) = 40(1 - e^{-0.8t})$$

and an initial guess  $t_1 = 1$ . Computations yield

$$\begin{aligned} t_1 &= 1, & g(t_1) &\approx -17.53355; \\ t_2 &= 1.79601, & g(t_2) &\approx 3.72461; \\ t_3 &= 1.67386, & g(t_3) &\approx 0.05864; \\ t_4 &= 1.67187, & g(t_4) &\approx 0.000017. \end{aligned}$$

Therefore, the object will hit the ground approximately after 1.67 sec.

6. We can use the model discussed in Example 1 of the text with  $m = 8$ ,  $b = 16$ ,  $g = 9.81$ , and the initial velocity  $v_0 = -20$  (the negative sign is due to the upward direction). The formula (6) yields

$$\begin{aligned} x(t) &= \frac{mg}{b}t + \frac{m}{b} \left( v_0 - \frac{mg}{b} \right) (1 - e^{-bt/m}) \\ &= \frac{(8)(9.81)}{16}t - \frac{8}{16} \left( 20 + \frac{(8)(9.81)}{16} \right) (1 - e^{-(16)t/8}) = 4.905t - 12.4525(1 - e^{-2t}). \end{aligned}$$

Because the object is released 100 m above the ground, we determine when the object strikes the ground by setting  $x(t) = 100$  and solving for  $t$ . Since the (positive) root belongs to  $[20, 24]$  (because  $x(20) < 100$  and  $x(24) > 100$ ), we can omit the exponential term in  $x(t)$  and solve

$$4.905t - 12.4525 = 100 \quad \Rightarrow \quad t = \frac{112.4525}{4.905} \approx 22.9 \text{ (sec)}.$$

8. Since the air resistance force has different coefficients of proportionality for closed and for opened chute, we need two differential equations describing the motion. Let  $x_1(t)$ ,  $x_1(0) = 0$ , denote the distance the parachutist has fallen in  $t$  seconds with the chute closed, and let  $v_1(t) = dx_1(t)/dt$  denote her velocity. With  $m = 100$ ,  $b = b_1 = 20$  N-sec/m, and  $v_0 = 0$  the initial value problem (4) of the text becomes

$$100 \frac{dv_1}{dt} = 100g - 20v_1 \quad \Rightarrow \quad \frac{dv_1}{dt} + \frac{1}{5}v_1 = g, \quad v_1(0) = 0.$$

This is a linear equation. Solving yields

$$\begin{aligned} dt (e^{t/5}v_1) &= e^{t/5}g & \Rightarrow & \quad v_1(t) = 5g + C_1e^{-t/5}; \\ 0 = v_1(0) &= 5g + C_1 & \Rightarrow & \quad C_1 = -5g \\ \Rightarrow & \quad v_1(t) = 5g(1 - e^{-t/5}) = 49.05(1 - e^{-t/5}) \\ \Rightarrow & \quad x_1(t) = \int_0^t v_1(s)ds = 49.05(s + 5e^{-s/5}) \Big|_{s=0}^{s=t} = 49.05(t + 5e^{-t/5} - 5). \end{aligned}$$

When the parachutist opens the chute  $t_1 = 30$  sec after leaving the helicopter, she is

$$3000 - x_1(30) \approx 1773.14$$

meters above the ground and traveling at a velocity

$$v_1(30) \approx 48.93 \text{ (m/sec)}.$$

Setting the second equation, we for convenience reset the time  $t$ . Denoting by  $x_2(t)$  the distance passed by the parachutist during  $t$  sec from the moment when the chute opens, and letting  $v_2(t) = dx_2(t)/dt$ , we have

$$100 \frac{dv_2}{dt} = 100g - 100v_2, \quad v_2(0) = v_1(30) = 48.93, \quad x_2(0) = 0.$$

## Chapter 3

Solving, we get

$$\begin{aligned}v_2(t) &= g + C_2 e^{-t}; \\48.93 &= v_2(0) = g + C_2 \quad \Rightarrow \quad C_2 = 48.93 - g = 39.12 \\ \Rightarrow \quad v_2(t) &= 9.81 + 39.12 e^{-t} \\ \Rightarrow \quad x_2(t) &= \int_0^t v_2(s) ds = (9.81s - 39.12e^{-s}) \Big|_{s=0}^{s=t} \\ &= 9.81t - 39.12e^{-t} + 39.12.\end{aligned}$$

With the chute open, the parachutist falls 1773.14 m. Solving  $x_2(t) = 1773.14$  for  $t$  yields

$$9.81t - 39.12e^{-t} + 39.12 = 1773.14 \quad \Rightarrow \quad t_2 \approx 176.76 \text{ (sec)}.$$

Therefore, the parachutist will hit the ground  $t_1 + t_2 = 30 + 176.76 = 206.76$  sec after dropping from the helicopter.

Repeating the above computations with  $t_1 = 60$ , we get

$$\begin{aligned}v_1(60) &\approx 49.05, \\x_1(60) &= 2697.75, \\v_2(t) &= 9.81 + 39.24e^{-t}, \\x_2(t) &= 9.81t - 39.24e^{-t} + 39.24.\end{aligned}$$

Solving  $x_2(t) = 3000 - 2697.75 = 302.25$  for  $t$  yields  $t_2 \approx 26.81$  so that the parachutist will land after  $t_1 + t_2 = 86.81$  (sec).

**10.** The motion of the object is governed by two different equations. The first equation describes the motion in the air, the second one corresponds to the motion in the water.

For the motion in the air, we let  $x_1(t)$  be the distance from the object to the platform and denote by  $v_1(t) = x_1'(t)$  its velocity at time  $t$ . Here we can use the model described in Example 1 of the text with  $m = 2$ ,  $b = b_1 = 10$ ,  $v_0 = v_1(0) = 0$ , and  $g = 9.81$ . Thus, using formulas (5) and (6), we get

$$\begin{aligned}v(t) &= \frac{mg}{b} + \left(v_0 - \frac{mg}{b}\right) e^{-bt/m} = 1.962(1 - e^{-5t}), \\x(t) &= \frac{mg}{b}t - \frac{m}{b} \left(v_0 - \frac{mg}{b}\right) (1 - e^{-bt/m}) = 1.962t - 0.392(1 - e^{-5t}).\end{aligned}$$

Therefore, solving

$$x_1(t) = 1.962t - 0.392(1 - e^{-5t}) = 30,$$

we obtain  $t \approx 15.5$  sec for the time when the object hit the water. The velocity of the object at this moment was

$$v_1(15.5) = 1.962(1 - e^{-5(15.5)}) \approx 1.962.$$

We now go to the motion of the object in the water. For convenience, we reset the time. Denoting by  $x_2(t)$  the distance passed by the object from the water surface and by  $v_2(t)$  – its velocity at (reset) time  $t$ , we get we obtain initial conditions

$$v_2(0) = 1.962, \quad x_2(0) = 0.$$

For this motion, in addition to the gravity force  $F_g = mg$  and the resistance force  $F_r = -100v$ , the buoyancy force  $F_b = -(1/2)mg$  is presented. Hence, the Newton's second law yields

$$\begin{aligned} m \frac{dv_2}{dt} &= mg - 100v - \frac{1}{2}mg = \frac{1}{2}mg - 100v \\ \Rightarrow \quad \frac{dv_2}{dt} &= \frac{g}{2} - \frac{100}{m}v_2 = 4.905 - 50v_2. \end{aligned}$$

Solving the first equation and using the initial condition yields

$$\begin{aligned} v_2(t) &= 0.098 + Ce^{-50t}, \\ v_2(0) &= 0.098 + C = 1.962 \quad \Rightarrow \quad C = 1.864 \\ \Rightarrow \quad v_2(t) &= 0.098 + 1.864e^{-50t} \\ \Rightarrow \quad x_2(t) &= \int_0^t v_2(s)ds = 0.098t - 0.037e^{-50t} + 0.037. \end{aligned}$$

Combining the obtained formulas for the motion of the object in the air and in the water and taking into account the time shift made, we obtain the following formula for the distance from the object to the platform

$$x(t) = \begin{cases} 1.962t - 0.392(1 - e^{-5t}), & t \leq 15.5 \\ 0.0981(t - 15.5) - 0.037e^{-50(t-15.5)} + 30.037, & t > 15.5. \end{cases}$$

1 min after the object was released, it traveled in the water for  $60 - 15.5 = 44.5$  sec. Therefore, it had the velocity

$$v_2(44.5) \approx 0.098 \text{ (m/sec)}.$$



## Chapter 3

- 12.** We denote by  $x(t)$  the distance from the shell to the ground at time  $t$ , and let  $v(t) = x'(t)$  be its velocity. Choosing positive upward direction, we get initial conditions

$$x(0) = 0, \quad v(0) = 200.$$

There are two forces acting on the shell: the gravity force  $F_g = -mg$  (with the *negative* sign due to the *upward* positive direction) and the air resistance force  $F_r = -v/20$  (with the *negative* sign because air resistance acts in *opposition* to the motion). Thus, we obtain an equation

$$m \frac{dv}{dt} = -mg - \frac{v}{20} \quad \Rightarrow \quad \frac{dv}{dt} = -g - \frac{v}{20m} = -g - \frac{v}{40}.$$

Solving this linear equation yields

$$v(t) = -40g + Ce^{-t/40} = -392.4 + Ce^{-t/40}.$$

Taking into account the initial condition, we find  $C$ .

$$200 = v(0) = -392.4 + C \quad \Rightarrow \quad C = 592.4 \quad \Rightarrow \quad v(t) = -392.4 + 592.4e^{-t/40}.$$

At the point of maximum height,  $v(t) = 0$ . Solving

$$v(t) = -392.4 + 592.4e^{-t/40} = 0 \quad \Rightarrow \quad t = 40 \ln \left( \frac{592.4}{392.4} \right) \approx 16.476,$$

we conclude that the shell reaches its maximum height 16.476 sec after the shot. Since

$$x(t) = \int_0^t v(t) dt = -392.4t + 23696 (1 - e^{-t/40}),$$

substituting  $t = 16.476$ , we find that the maximum height of the shell is

$$x(16.476) \approx 1534.81 \text{ (m)}.$$

- 14.** We choose downward positive direction and denote by  $v(t)$  the velocity of the object at time  $t$ . There are two forces acting on the object: the gravity force  $F_g = mg$  and the air resistance force  $F_r = -bv^n$  (with the *negative* sign because air resistance acts in *opposition* to the motion). Thus, we obtain an equation

$$m \frac{dv}{dt} = mg - bv^n \quad \Rightarrow \quad \frac{dv}{dt} = g - \frac{b}{m} v^n.$$

Assuming that a finite limit

$$\lim_{t \rightarrow \infty} v(t) = V$$

exists and using the equation of the motion, we conclude that

(i) the limit

$$\lim_{t \rightarrow \infty} [v(t+1) - v(t)] = \lim_{t \rightarrow \infty} v(t+1) - \lim_{t \rightarrow \infty} v(t) = 0;$$

(ii)  $v'(t)$  has a finite limit at infinity and, moreover,

$$\lim_{t \rightarrow \infty} v'(t) = \lim_{t \rightarrow \infty} \left( g - \frac{b}{m} v^n \right) = g - \frac{b}{m} V^n.$$

By Mean Value Theorem, for any  $N = 0, 1, 2, \dots$

$$v(N+1) - v(N) = v'(\theta_N), \quad \theta_N \in (N, N+1).$$

Therefore, (i) yields

$$\lim_{N \rightarrow \infty} v'(\theta_N) = 0,$$

and so, by (ii),  $v'(t)$  has zero limit at infinity and

$$g - \frac{b}{m} V^n = 0 \quad \Rightarrow \quad V = \sqrt[n]{\frac{mg}{b}}.$$

- 16.** The total torque exerted on the flywheel is the sum of the torque exerted by the motor and the retarding torque due to friction. Thus, by Newton's second law for rotation, we have

$$I \frac{d\omega}{dt} = T - k\sqrt{\omega} \quad \text{with} \quad \omega(0) = \omega_0,$$

where  $I$  is the moment of inertia of the flywheel,  $\omega(t)$  is the angular velocity,  $d\omega/dt$  is the angular acceleration,  $T$  is the constant torque exerted by the motor, and  $k$  is a positive constant of proportionality for the torque due to friction. Separating variables yields

$$\frac{d\omega}{\sqrt{\omega} - (T/k)} = -\frac{k}{I} dt.$$

Since

$$\begin{aligned} \int \frac{dx}{\sqrt{x} - a} &= (x = y^2, dx = 2y dy) = 2 \int \frac{y dy}{y - a} = 2 \left[ \int dy + a \int \frac{dy}{y - a} \right] \\ &= 2(y + a \ln |y - a|) + C = 2(\sqrt{x} + a \ln |\sqrt{x} - a|) + C, \end{aligned}$$

integrating the above equation, we obtain

$$\begin{aligned} 2(\sqrt{\omega} + (T/k) \ln |\sqrt{\omega} - (T/k)|) + C &= -\frac{k}{I} t \\ \Rightarrow k\sqrt{\omega} + T \ln |k\sqrt{\omega} - T| &= -\frac{k^2}{2I} t + C_1. \end{aligned}$$

## Chapter 3

Using the initial condition  $\omega(0) = \omega_0$ , we find that

$$C_1 = k\sqrt{\omega_0} + T \ln |k\sqrt{\omega_0} - T|.$$

Hence,  $\omega(t)$  is given implicitly by

$$k(\sqrt{\omega} - \sqrt{\omega_0}) + T \ln \left| \frac{k\sqrt{\omega} - T}{k\sqrt{\omega_0} - T} \right| = -\frac{k^2 t}{2I}.$$

18. Since we assume that there is no resistance force, there are only two forces acting on the object:  $F_g$ , the force due to gravity, and  $F_f$ , the friction force. Using Fig. 3.11 in the text, we obtain

$$F_g = mg \sin 30^\circ = \frac{mg}{2},$$
$$F_f = -\mu N = -\mu mg \cos 30^\circ = -\frac{\mu mg \sqrt{3}}{2},$$

and so the equation describing the motion is

$$m \frac{dv}{dt} = \frac{mg}{2} - \frac{\mu mg \sqrt{3}}{2} \quad \Rightarrow \quad \frac{dv}{dt} = \frac{g}{2} (1 - \mu \sqrt{3}) = \frac{g(5 - \sqrt{3})}{10}$$

with the initial condition  $v(0) = 0$ . Therefore,

$$v(t) = \int_0^t \frac{g(5 - \sqrt{3})}{10} ds = \frac{g(5 - \sqrt{3})}{10} s \Big|_{s=0}^{s=t} = \frac{g(5 - \sqrt{3})}{10} t$$
$$\Rightarrow x(t) = \int_0^t v(s) ds = \frac{g(5 - \sqrt{3})}{20} s^2 \Big|_{s=0}^{s=t} = \frac{g(5 - \sqrt{3})}{20} t^2.$$

Solving

$$x(t) = \frac{g(5 - \sqrt{3})}{20} t^2 = 5 \quad \Rightarrow \quad t^* = \frac{10}{\sqrt{g(5 - \sqrt{3})}},$$

we conclude that the object will reach the bottom of the plane  $t^*$  sec after it is released having the velocity

$$v(t^*) = \frac{g(5 - \sqrt{3})}{10} \cdot \frac{10}{\sqrt{g(5 - \sqrt{3})}} = \sqrt{g(5 - \sqrt{3})} \approx 5.66 \text{ (m/sec)}.$$

We remark that the mass of the object is irrelevant.

20. The gravitational force  $F_g$  down the incline is

$$F_g = mg \sin \alpha,$$

the force  $F_f$  due to static friction satisfies

$$F_f \leq \mu N = \mu mg \cos \alpha.$$

The object will slide if  $F_g > F_f$ . In the worst case, that is, in the case when the friction force is the largest possible, the angle  $\alpha$  must satisfy

$$mg \sin \alpha > \mu mg \cos \alpha \quad \Rightarrow \quad \tan \alpha > \mu \quad \Rightarrow \quad \alpha > \arctan \mu.$$

Thus,  $\alpha_0 = \arctan \mu$ .

22. In this problem, there are two forces acting on a sailboat: a constant horizontal force due to the wind and a force due to the water resistance that acts in opposition to the motion of the sailboat. All of the motion occurs along a horizontal axis. On this axis, we choose the origin to be the point, where the boat begins to “plane”, set  $t = 0$  at this moment, and let  $x(t)$  and  $v(t) = x'(t)$  denote the distance the sailboat travels in time  $t$  and its velocity, respectively. The force due to the wind is still

$$F_w = 600 \text{ N.}$$

The force due to water resistance is now

$$F_r = -60v \text{ N.}$$

Applying Newton’s second law we obtain

$$50 \frac{dv}{dt} = 600 - 60v \quad \Rightarrow \quad \frac{dv}{dt} = \frac{6}{5} (10 - v).$$

Since the velocity of the sailboat at  $t = 0$  is 5 m/sec, a model for the velocity of the moving sailboat is expressed as the initial value problem

$$\frac{dv}{dt} = \frac{6}{5} (10 - v), \quad v(0) = 5.$$

Separating variables and integrating yields

$$\frac{dv}{v - 10} = -\frac{6dt}{5} \quad \Rightarrow \quad \ln(v - 10) = -\frac{6t}{5} + C_1 \quad \Rightarrow \quad v(t) = 10 + Ce^{-6t/5}.$$

## Chapter 3

Setting  $v = 5$  when  $t = 0$ , we find that  $5 = 10 + C$  so that  $C = -5$  and  $v(t) = 10 - 5e^{-6t/5}$ . The limiting velocity of the sailboat under these conditions is

$$\lim_{t \rightarrow \infty} v(t) = \lim_{t \rightarrow \infty} (10 - 5e^{-6t/5}) = 10 \text{ (m/sec)}.$$

To find the equation of motion, we integrate  $v(t)$  using the initial condition  $x(0) = 0$ .

$$x(t) = \int_0^t (10 - 5e^{-6s/5}) ds = \left( 10s + \frac{25}{6} e^{-6s/5} \right) \Big|_0^t = 10t + \frac{25}{6} (e^{-6t/5} - 1).$$

24. Dividing the equation by  $m_0 - \alpha t$  yields

$$\begin{aligned} \frac{dv}{dt} &= -g + \frac{\alpha\beta}{m_0 - \alpha t} \\ \Rightarrow v(t) &= \int_0^t \left( -g + \frac{\alpha\beta}{m_0 - \alpha s} \right) ds + v(0) \\ &= [-gs - \beta \ln(m_0 - \alpha s)] \Big|_{s=0}^{s=t} = -gt + \beta \ln \frac{m_0}{m_0 - \alpha t}, \end{aligned}$$

where we used the condition  $0 \leq t < m_0/\alpha$  so that  $m_0 - \alpha t > 0$ .

Since the height  $h(t)$  of the rocket satisfies  $h(0) = 0$ , we find

$$\begin{aligned} h(t) &= \int_0^t v(s) ds = \int_0^t \left( -gs + \beta \ln \frac{m_0}{m_0 - \alpha s} \right) ds \\ &= \left[ -\frac{gs^2}{2} + \beta s \ln m_0 + \frac{\beta}{\alpha} (m_0 - \alpha s) \ln \frac{m_0 - \alpha s}{e} \right] \Big|_{s=0}^{s=t} \\ &= \beta t - \frac{gt^2}{2} - \frac{\beta}{\alpha} (m_0 - \alpha t) \ln \frac{m_0}{m_0 - \alpha t}. \end{aligned}$$

### EXERCISES 3.5: Electrical Circuits

$$2. \text{ Capacitor voltage} = -\frac{10000}{100000001} \cos 100t + \frac{100000000}{100000001} \sin 100t + \frac{10000}{100000001} e^{-1000000t} \text{ V}$$

$$\text{Resistor voltage} = \frac{10000}{100000001} \cos 100t + \frac{1}{100000001} \sin 100t - \frac{10000}{100000001} e^{-1000000t} \text{ V}$$

$$\text{Current} = \frac{10000}{100000001} \cos 100t + \frac{1}{100000001} \sin 100t - \frac{10000}{100000001} e^{-1000000t} \text{ A}$$

$$4. \text{ From (2), } I = \frac{1}{L} \int E(t) dt. \text{ From the derivative of (4), } I = C \frac{dE}{dt}$$

6. Multiply (2) by  $I$  to derive  $\frac{d}{dt} \left( \frac{1}{2} LI^2 \right) + RI^2 = EI$  (power generated by the voltage source equals the power inserted into the inductor plus the power dissipated by the resistor). Multiply the equation above (4) by  $I$ , replace  $I$  by  $dq/dt$  and then replace  $q$  by  $CE_C$  in the capacitor term, and derive  $RI^2 + \frac{d}{dt} \left( \frac{1}{2} CE_C^2 \right) = EI$  (power generated by the voltage source equals the power inserted into the capacitor plus the power dissipated by the resistor).
8. In cold weather, 96.27 hours. In (*extremely*) humid weather, 0.0485 seconds.

### EXERCISES 3.6: Improved Euler's Method

6. For  $k = 0, 1, 2, \dots, n$ , let  $x_k = kh$  and  $z_k = f(x_k)$ , where  $h = 1/n$ .
- (a)  $h(z_0 + z_1 + z_2 + \dots + z_{n-1})$
- (b)  $(h/2)(z_0 + 2z_1 + 2z_2 + \dots + 2z_{n-1} + z_n)$
- (c)  $(h/2)(z_0 + 2z_1 + 2z_2 + \dots + 2z_{n-1} + z_n)$
8. See Table 3–A on page 98.
10. See Table 3–B on page 98.
12.  $\phi(\pi) \approx y(\pi; \pi 2^{-4}) \approx 1.09589$
14. 2.36 at  $x = 0.78$
16.  $x = 1.26$
20. See Table 3–C on page 99.

### EXERCISES 3.7: Higher-Order Numerical Methods: Taylor and Runge-Kutta

2.  $y_{n+1} = y_n + h(x_n y_n - y_n^2) + (h^2/2!) [y_n + (x_n - 2y_n)(x_n y_n - y_n^2)]$
4.  $y_{n+1} = y_n + h(x_n^2 + y_n) + (h^2/2!)(2x_n + x_n^2 + y_n) + (h^3/3!)(2 + 2x_n + x_n^2 + y_n) + (h^4/4!)(2 + 2x_n + x_n^2 + y_n)$
6. Order 2:  $\phi(1) \approx 0.62747$   
Order 4:  $\phi(1) \approx 0.63231$

## Chapter 3

- 8. 0.63211
- 10. 0.70139 with  $h = 0.25$
- 12.  $-0.928$  at  $x = 1.2$
- 14. 1.00000 with  $h = \pi/16$
- 16. See Table **3–D** on page 100.
- 20.  $x(10) \approx 2.23597 \times 10^{-4}$

### TABLES

---

**Table 3–A:** Improved Euler’s method approximations in Problem 8.

$x_n$	1.2	1.4	1.6	1.8
$y_n$	1.48	2.24780	3.65173	6.88712

---

**Table 3–B:** Improved Euler’s method approximations in Problem 10.

$x_n$	$y_n$
0.1	1.15845
0.2	1.23777
0.3	1.26029
0.4	1.24368
0.5	1.20046
0.6	1.13920
0.7	1.06568
0.8	0.98381
0.9	0.89623
1.0	0.80476

---

**Table 3–C:** Improved Euler’s method approximations in Problem 20.

---

$t$	$r = 1.0$	$r = 1.5$	$r = 2.0$
0	0.0	0.0	0.0
0.2	1.56960	1.41236	1.19211
0.4	2.63693	2.14989	1.53276
0.6	3.36271	2.51867	1.71926
0.8	3.85624	2.70281	1.84117
1.0	4.19185	2.79483	1.92743
1.2	4.42005	2.84084	1.99113
1.4	4.57524	2.86384	2.03940
1.6	4.68076	2.87535	2.07656
1.8	4.75252	2.88110	2.10548
2.0	4.80131	2.88398	2.12815
2.2	4.83449	2.88542	2.14599
2.4	4.85705	2.88614	2.16009
2.6	4.87240	2.88650	2.17126
2.8	4.88283	2.88668	2.18013
3.0	4.88992	2.88677	2.18717
3.2	4.89475	2.88682	2.19277
3.4	4.89803	2.88684	2.19723
3.6	4.90026	2.88685	2.20078
3.8	4.90178	2.88686	2.20360
4.0	4.90281	2.88686	2.20586
4.2	4.90351	2.88686	2.20765
4.4	4.90399	2.88686	2.20908
4.6	4.90431	2.88686	2.21022
4.8	4.90453	2.88686	2.21113
5.0	4.90468	2.88686	2.21186

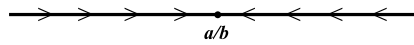
---



**Table 3–D:** Fourth-order Runge-Kutta approximations in Problem 16.

$x_n$	$y_n$
0.5	1.17677
1.0	0.37628
1.5	1.35924
2.0	2.66750
2.5	2.00744
3.0	2.72286
3.5	4.11215
4.0	3.72111

---

**FIGURES****Figure 3–A:** The phase line for  $x' = a - bx$  in Problem 10.

---

## CHAPTER 4: Linear Second Order Equations

### EXERCISES 4.1: Introduction: The Mass-Spring Oscillator

2. (a) Substituting  $cy(t)$  into the equation yields

$$m(cy)'' + b(cy)' + k(cy) = c(my'' + by' + ky) = 0.$$

- (b) Substituting  $y_1(t) + y_2(t)$  into the given equation, we obtain

$$\begin{aligned} m(y_1 + y_2)'' + b(y_1 + y_2)' + k(y_1 + y_2) &= (my_1'' + by_1' + ky_1) \\ &\quad + (my_2'' + by_2' + ky_2) = 0. \end{aligned}$$

4. With  $F_{\text{ext}} = 0$ ,  $m = 1$ ,  $k = 9$ , and  $b = 6$  equation (3) becomes

$$y'' + 6y' + 9y = 0.$$

Substitution  $y_1 = e^{-3t}$  and  $y_2 = te^{-3t}$  yields

$$\begin{aligned} (e^{-3t})'' + 6(e^{-3t})' + 9(e^{-3t}) &= 9e^{-3t} - 18e^{-3t} + 9e^{-3t} = 0, \\ (te^{-3t})'' + 6(te^{-3t})' + 9(te^{-3t}) &= (9t - 6)e^{-3t} + 6(1 - 3t)e^{-3t} + 9te^{-3t} = 0. \end{aligned}$$

Thus,  $y_1 = e^{-3t}$  and  $y_2 = te^{-3t}$  are solutions to the given equation.

Both solutions approach zero as  $t \rightarrow \infty$ .

6. With  $F_{\text{ext}} = 2 \cos 2t$ ,  $m = 1$ ,  $k = 4$ , and  $b = 0$ , the equation (3) has the form

$$y'' + 4y' = 2 \cos 2t.$$

For  $y(t) = (1/2)t \sin 2t$ , one has

$$\begin{aligned} y'(t) &= \frac{1}{2} \sin 2t + t \cos 2t, & y''(t) &= 2 \cos 2t - 2t \sin 2t; \\ y'' + 4y' &= (2 \cos 2t - 2t \sin 2t) + 4 \left( \frac{1}{2} t \sin 2t \right) &= 2 \cos 2t. \end{aligned}$$

## Chapter 4

Hence,  $y(t) = (1/2)t \sin 2t$  is a solution. Clearly, this function satisfies the initial conditions. Indeed,

$$y(0) = \frac{1}{2} t \sin 2t \Big|_{t=0} = 0$$

$$y'(0) = \frac{1}{2} \sin 2t + t \cos 2t \Big|_{t=0} = 0.$$

As  $t$  increases, the spring will eventually break down since the solution oscillates with the magnitude increasing without bound.

8. For  $y = A \cos 3t + B \sin 3t$ ,

$$y' = -3A \sin 3t + 3B \cos 3t, \quad y'' = -9A \cos 3t - 9B \sin 3t.$$

Inserting  $y$ ,  $y'$ , and  $y''$  into the given equation and matching coefficients yield

$$y'' + 2y' + 4y = 5 \sin 3t$$

$$\Rightarrow (-9A \cos 3t - 9B \sin 3t) + 2(-3A \sin 3t + 3B \cos 3t) + 4(A \cos 3t + B \sin 3t)$$

$$= (-5A + 6B) \cos 3t + (-6A - 5B) \sin 3t = 5 \sin 3t$$

$$\Rightarrow \begin{array}{l} -5A + 6B = 0 \\ -6A - 5B = 5 \end{array} \Rightarrow \begin{array}{l} A = -30/61 \\ B = -25/61. \end{array}$$

Thus,

$$y = -(30/61) \cos 3t - (25/61) \sin 3t$$

is a synchronous solution to  $y'' + 2y' + 4y = 5 \sin 3t$ .

10. (a) We seek solutions to (7) of the form  $y = A \cos \Omega t + B \sin \Omega t$ . Since

$$y' = -A\Omega \sin \Omega t + B\Omega \cos \Omega t,$$

$$y'' = -A\Omega^2 \cos \Omega t - B\Omega^2 \sin \Omega t,$$

we insert these equations into (7), collect similar terms, and match coefficients.

$$m(-A\Omega^2 \cos \Omega t - B\Omega^2 \sin \Omega t) + b(-A\Omega \sin \Omega t + B\Omega \cos \Omega t)$$

$$+ k(A \cos \Omega t + B \sin \Omega t)$$

$$= (-mA\Omega^2 + bB\Omega + kA) \cos \Omega t + (-mB\Omega^2 - bA\Omega + kB) \sin \Omega t = \cos \Omega t$$

$$\Rightarrow \begin{cases} -mA\Omega^2 + bB\Omega + kA = 1 \\ -mB\Omega^2 - bA\Omega + kB = 0 \end{cases}$$

$$\begin{aligned} \Rightarrow & \begin{cases} A(-m\Omega^2 + k) + B(b\Omega) = 1 \\ A(-b\Omega) + B(-m\Omega^2 + k) = 0 \end{cases} \\ \Rightarrow & A = -\frac{m\Omega^2 - k}{(m\Omega^2 - k)^2 + b^2\Omega^2}, \quad B = \frac{b\Omega}{(m\Omega^2 - k)^2 + b^2\Omega^2} \\ \Rightarrow & y = -\frac{m\Omega^2 - k}{(m\Omega^2 - k)^2 + b^2\Omega^2} \cos \Omega t + \frac{b\Omega}{(m\Omega^2 - k)^2 + b^2\Omega^2} \sin \Omega t. \end{aligned}$$

(b) With  $m = 1$ ,  $b = 0.1$ , and  $k = 25$ , the coefficients  $A$  and  $B$  in part (a) are

$$A(\Omega) = -\frac{\Omega^2 - 25}{(\Omega^2 - 25)^2 + 0.01}, \quad B(\Omega) = \frac{0.1\Omega^2}{(\Omega^2 - 25)^2 + 0.01}.$$

The graphs of these functions are shown in Fig. 4–A on page 173.

(c) If  $m = 1$ ,  $b = 0$ , and  $k = 25$ , the coefficients  $A$  and  $B$  in part (a) become

$$A(\Omega) = -\frac{1}{\Omega^2 - 25}, \quad B(\Omega) \equiv 0.$$

The graphs of these functions are shown in Fig. 4–B, page 173.

(d) If  $b = 0$ , then equation (7) reduces to  $my'' + ky = \cos \Omega t$ .

Substituting  $y = A \cos \Omega t + B \sin \Omega t$  yields

$$\begin{aligned} m(-A\Omega^2 \cos \Omega t - B\Omega^2 \sin \Omega t) + k(A \cos \Omega t + B \sin \Omega t) &= \cos \Omega t \\ \Rightarrow (-m\Omega^2 + k)(A \cos \Omega t + B \sin \Omega t) &= \cos \Omega t. \end{aligned}$$

Assuming now that  $\Omega = \sqrt{k/m}$ , we get  $-m\Omega^2 + k = 0$ , and so the above equation is impossible with any choice of  $A$  and  $B$ .

(e) Differentiating  $y = (2m\Omega)^{-1}t \sin \Omega t$  twice, we obtain

$$\begin{aligned} y' &= \frac{1}{2m\Omega} (\sin \Omega t + t\Omega \cos \Omega t), \quad y'' = \frac{1}{2m} (2 \cos \Omega t - t\Omega \sin \Omega t) \\ my'' + ky &= \frac{1}{2} (2 \cos \Omega t - t\Omega \sin \Omega t) + \frac{k}{2m\Omega} t \sin \Omega t \\ &= \cos \Omega t + \left(-\Omega + \frac{k}{m\Omega}\right) \frac{t \sin \Omega t}{2} = \cos \Omega t, \end{aligned}$$

since  $-\Omega + k/(m\Omega) = 0$  if  $\Omega = \sqrt{k/m}$ .

## EXERCISES 4.2: Homogeneous Linear Equations: The General Solution

2. The auxiliary equation,  $r^2 + 6r + 9 = (r + 3)^2 = 0$ , has a double root  $r = -3$ . Therefore,  $e^{-3t}$  and  $te^{-3t}$  are two linearly independent solutions for this differential equation, and

## Chapter 4

a general solution is given by

$$y(t) = c_1e^{-3t} + c_2te^{-3t},$$

where  $c_1$  and  $c_2$  are arbitrary constants.

4. The auxiliary equation for this problem is  $r^2 - r - 2 = (r - 2)(r + 1) = 0$ , which has the roots  $r = 2$  and  $r = -1$ . Thus  $\{e^{2t}, e^{-t}\}$  is a set of two linearly independent solutions to this differential equation. Therefore, a general solution is given by

$$y(t) = c_1e^{2t} + c_2e^{-t},$$

where  $c_1$  and  $c_2$  are arbitrary constants.

6. The auxiliary equation for this problem is  $r^2 - 5r + 6 = 0$  with roots  $r = 2, 3$ . Therefore, a general solution is

$$y(t) = c_1e^{2t} + c_2e^{3t}.$$

8. Solving the auxiliary equation,  $6r^2 + r - 2 = 0$ , yields  $r = -2/3, 1/2$ . Thus a general solution is given by

$$y(t) = c_1e^{t/2} + c_2e^{-2t/3},$$

where  $c_1$  and  $c_2$  are arbitrary constants.

10. Solving the auxiliary equation,  $4r^2 - 4r + 1 = (2r - 1)^2 = 0$ , we conclude that  $r = 1/2$  is its double root. Therefore, a general solution to the given differential equation is

$$y(t) = c_1e^{t/2} + c_2te^{t/2}.$$

12. The auxiliary equation for this problem is  $3r^2 + 11r - 7 = 0$ . Using the quadratic formula yields

$$r = \frac{-11 \pm \sqrt{121 + 84}}{6} = \frac{-11 \pm \sqrt{205}}{6}.$$

Thus, a general solution to the given equation is

$$y(t) = c_1e^{(-11+\sqrt{205})t/6} + c_2e^{(-11-\sqrt{205})t/6}.$$

14. The auxiliary equation for this problem is  $r^2 + r = 0$ , which has roots  $r = -1, 0$ . Thus, a general solution is given by

$$y(t) = c_1e^{-t} + c_2,$$

where  $c_1, c_2$  are arbitrary constants. To satisfy the initial conditions,  $y(0) = 2, y'(0) = 1$ , we find the derivative  $y'(t) = -c_1e^{-t}$  and solve the system

$$\begin{aligned} y(0) &= c_1e^{-0} + c_2 = c_1 + c_2 = 2 & \Rightarrow & & c_1 &= -1 \\ y'(0) &= -c_1e^{-0} = -c_1 = 1 & & & c_2 &= 3. \end{aligned}$$

Therefore, the solution to the given initial value problem is

$$y(t) = -e^{-t} + 3.$$

- 16.** The auxiliary equation for this problem,  $r^2 - 4r + 3 = 0$ , has roots  $r = 1, 3$ . Therefore, a general solution is given by

$$y(t) = c_1e^t + c_2e^{3t} \quad \Rightarrow \quad y'(t) = c_1e^t + 3c_2e^{3t}.$$

Substitution of  $y(t)$  and  $y'(t)$  into the initial conditions yields the system

$$\begin{aligned} y(0) &= c_1 + c_2 = 1 & \Rightarrow & & c_1 &= 4/3 \\ y'(0) &= c_1 + 3c_2 = 1/3 & & & c_2 &= -1/3. \end{aligned}$$

Thus, the solution satisfying the given initial conditions is

$$y(t) = \frac{4}{3}e^t - \frac{1}{3}e^{3t}.$$

- 18.** The auxiliary equation for this differential equation is  $r^2 - 6r + 9 = (r - 3)^2 = 0$ . We see that  $r = 3$  is a repeated root. Thus, two linearly independent solutions are  $y_1(t) = e^{3t}$  and  $y_2(t) = te^{3t}$ . This means that a general solution is given by  $y(t) = c_1e^{3t} + c_2te^{3t}$ .

To find the constants  $c_1$  and  $c_2$ , we substitute the initial conditions into the general solution and its derivative,  $y'(t) = 3c_1e^{3t} + c_2(e^{3t} + 3te^{3t})$ , and obtain

$$\begin{aligned} y(0) &= 2 = c_1 \\ y'(0) &= 25/3 = 3c_1 + c_2. \end{aligned}$$

So,  $c_1 = 2$  and  $c_2 = 7/3$ . Therefore, the solution that satisfies the initial conditions is given by

$$y(t) = 2e^{3t} + \frac{7}{3}te^{3t} = \left(\frac{7t}{3} + 2\right)e^{3t}.$$

## Chapter 4

- 20.** The auxiliary equation for this differential equation,  $r^2 - 4r + 4 = (r - 2)^2 = 0$ , has a double root  $r = 2$ . Thus, two linearly independent solutions are  $y_1(t) = e^{2t}$  and  $y_2(t) = te^{2t}$ . This means that a general solution is given by  $y(t) = (c_1 + c_2t)e^{2t}$ .

Substituting the initial conditions into the general solution and its derivative yields

$$\begin{aligned}y(1) &= (c_1 + c_2t)e^{2t}|_{t=1} = (c_1 + c_2)e^2 = 1 \\y'(1) &= (c_2 + 2c_1 + 2c_2t)e^{2t}|_{t=1} = (2c_1 + 3c_2)e^2 = 1.\end{aligned}$$

So,  $c_1 = 2e^{-2}$  and  $c_2 = -e^{-2}$ . Therefore, the solution is

$$y(t) = (2e^{-2} - e^{-2}t)e^{2t} = (2 - t)e^{2t-2}.$$

- 22.** We substitute  $y = e^{rt}$  into the given equation and get

$$3re^{rt} - 7e^{rt} = (3r - 7)e^{rt} = 0.$$

Therefore,

$$3r - 7 = 0 \quad \Rightarrow \quad r = \frac{7}{3},$$

and a general solution to the given differential equation is  $y(t) = ce^{7t/3}$ , where  $c$  is an arbitrary constant.

- 24.** Similarly to the previous problem, we find the characteristic equation,  $3r + 11 = 0$ , which has the root  $r = -11/3$ . Therefore, a general solution is given by  $z(t) = ce^{-11t/3}$ .

- 26. (a)** Substituting boundary conditions into  $y(t) = c_1 \cos t + c_2 \sin t$  yields

$$\begin{aligned}2 &= y(0) = c_1 \\0 &= y(\pi/2) = c_2.\end{aligned}$$

Thus,  $c_1$  and  $c_2$  are determined uniquely, and so the given boundary value problem has a unique solution  $y = 2 \cos t$ .

- (b)** Similarly to part (a), we obtain a system to determine  $c_1$  and  $c_2$ .

$$\begin{aligned}2 &= y(0) = c_1 \\0 &= y(\pi) = -c_1.\end{aligned}$$

However, this system is inconsistent, and so there is no solution satisfying given boundary conditions.

(c) This time, we come up with a system

$$\begin{aligned} 2 &= y(0) = c_1 \\ -2 &= y(\pi) = -c_1, \end{aligned}$$

which has infinitely many solutions given by  $c_1 = 2$  and  $c_2$  – arbitrary. Thus, the boundary value problem has infinitely many solutions of the form

$$y = 2 \cos t + c_2 \sin t.$$

28. Assuming that  $y_1(t) = e^{3t}$  and  $y_2(t) = e^{-4t}$  are linearly dependent on  $(0, 1)$ , we conclude that, for some constant  $c$  and all  $t \in (0, 1)$ ,

$$y_1(t) = cy_2(t) \quad \Rightarrow \quad e^{3t} = ce^{-4t} \quad \Rightarrow \quad e^{7t} = c.$$

Since an exponential function is strictly monotone, this is a contradiction. Hence, given functions are linearly independent on  $(0, 1)$ .

30. These functions are linearly independent, because the equality  $y_1(t) \equiv cy_2(t)$  would imply that

$$t^2 \cos(\ln t) \equiv ct^2 \sin(\ln t) \quad \Rightarrow \quad \cot(\ln t) \equiv c$$

on  $(0, 1)$ , which is false.

32. These two functions are linearly dependent since  $y_1(t) \equiv 0 \cdot y_2(t)$ .

34. (a) This formula follows from the definition of  $2 \times 2$  determinant.

(b, c) If  $y_1(t)$  and  $y_2(t)$  are linearly independent on  $I$ , then  $W[y_1, y_2](t)$  is never zero on  $I$  since, otherwise, these functions would be linearly dependent by Lemma 1. On the other hand, if  $y_1(t)$  and  $y_2(t)$  are any two differentiable functions that are linearly dependent on  $I$ , then, say,  $y_1(t) \equiv cy_2(t)$  on  $I$  and so

$$W[y_1, y_2](t) = y_1 (cy_2)' - y_1' (cy_2) \equiv 0 \quad \text{on } I.$$

36. Assume to the contrary that  $e^{r_1 t}$ ,  $e^{r_2 t}$ , and  $e^{r_3 t}$  are linearly dependent. Without loss of generality, let

$$e^{r_1 t} = c_1 e^{r_2 t} + c_2 e^{r_3 t} \quad \Rightarrow \quad e^{(r_1 - r_2)t} = c_1 + c_2 e^{(r_3 - r_2)t}$$



## Chapter 4

for all  $t$ . Differentiating this identity, we obtain

$$(r_1 - r_2) e^{(r_1 - r_2)t} \equiv c_2 (r_3 - r_2) e^{(r_3 - r_2)t}.$$

Since  $r_1 - r_2 \neq 0$ , dividing both sides by  $(r_1 - r_2) e^{(r_1 - r_2)t}$ , we obtain

$$\frac{c_2 (r_3 - r_2)}{(r_1 - r_2)} e^{(r_3 - r_1)t} \equiv 1 \quad \Rightarrow \quad c_2 e^{(r_3 - r_1)t} \equiv 1$$

on  $(-\infty, \infty)$ , which is a contradiction ( $r_3 - r_1 \neq 0!$ ).

**38.** The auxiliary equation for this problem is  $r^3 - 6r^2 - r + 6 = 0$ . Factoring yields

$$r^3 - 6r^2 - r + 6 = (r^3 - 6r^2) - (r - 6) = r^2(r - 6) - (r - 6) = (r - 6)(r^2 - 1).$$

Thus the roots of the auxiliary equation are  $r = \pm 1$  and  $r = 6$ . Therefore, the functions  $e^t$ ,  $e^{-t}$ , and  $e^{6t}$  are solutions to the given equation, and they are linearly independent on  $(-\infty, \infty)$  (see Problem 40), and a general solution to the equation  $y''' - 6y'' - y' + 6y = 0$  is given by

$$y(t) = c_1 e^t + c_2 e^{-t} + c_3 e^{6t}.$$

**40.** The auxiliary equation associated with this differential equation is  $r^3 - 7r^2 + 7r + 15 = 0$ . We see, by inspection, that  $r = -1$  is a root. Dividing  $r^3 - 7r^2 + 7r + 15$  by  $r + 1$ , we find that

$$r^3 - 7r^2 + 7r + 15 = (r + 1)(r^2 - 8r + 15) = (r + 1)(r - 3)(r - 5).$$

Hence  $r = -1, 3, 5$  are the roots to the auxiliary equation, and a general solution is

$$y(t) = c_1 e^{-t} + c_2 e^{3t} + c_3 e^{5t}.$$

**42.** By inspection, we see that  $r = 1$  is a root of the auxiliary equation,  $r^3 + r^2 - 4r + 2 = 0$ . Dividing the polynomial  $r^3 + r^2 - 4r + 2$  by  $r - 1$  yields

$$r^3 + r^2 - 4r + 2 = (r - 1)(r^2 + 2r - 2).$$

Hence, two other roots of the auxiliary equation are  $r = -1 \pm \sqrt{3}$ , and a general solution is given by

$$y(t) = c_1 e^t + c_2 e^{(-1+\sqrt{3})t} + c_3 e^{(-1-\sqrt{3})t}.$$

44. First we find a general solution to the equation  $y''' - 2y'' - y' + 2y = 0$ . Its characteristic equation,  $r^3 - 2r^2 - r + 2 = 0$ , has roots  $r = 2, 1$ , and  $-1$ , and so a general solution is given by

$$y(t) = c_1 e^{2t} + c_2 e^t + c_3 e^{-t}.$$

Differentiating  $y(t)$  twice yields

$$y'(t) = 2c_1 e^{2t} + c_2 e^t - c_3 e^{-t}, \quad y''(t) = 4c_1 e^{2t} + c_2 e^t + c_3 e^{-t}.$$

Now we substitute  $y, y'$ , and  $y''$  into the initial conditions and find  $c_1, c_2$ , and  $c_3$ .

$$\begin{aligned} y(0) = c_1 + c_2 + c_3 &= 2 & c_1 &= 1 \\ y'(0) = 2c_1 + c_2 - c_3 &= 3 & \Rightarrow & c_2 = 1 \\ y''(0) = 4c_1 + c_2 + c_3 &= 5 & & c_3 = 0. \end{aligned}$$

Therefore, the solution to the given initial value problem is

$$y(t) = e^{2t} + e^t.$$

46. (a) The characteristic equation associated with  $y'' - y = 0$  is  $r^2 - 1 = 0$ , which has distinct real roots  $r = \pm 1$ . Thus, a general solution is given by

$$y(t) = c_1 e^t + c_2 e^{-t}.$$

Differentiating  $y(t)$  yields  $y'(t) = c_1 e^t - c_2 e^{-t}$ . We now substitute  $y$  and  $y'$  into the initial conditions for  $\cosh t$  to find its explicit formula.

$$\begin{aligned} y(0) = c_1 + c_2 &= 1 & \Rightarrow & c_1 = 1/2 \\ y'(0) = c_1 - c_2 &= 0 & & c_2 = 1/2. \end{aligned}$$

Therefore,

$$\cosh t = \frac{e^t + e^{-t}}{2}.$$

Similarly, for  $\sinh t$ , we have

$$\begin{aligned} y(0) = c_1 + c_2 &= 0 & \Rightarrow & c_1 = 1/2 \\ y'(0) = c_1 - c_2 &= 1 & & c_2 = -1/2. \end{aligned}$$

Therefore,

$$\sinh t = \frac{e^t - e^{-t}}{2}.$$

## Chapter 4

Applying derivative rules, we find that

$$\begin{aligned}\frac{d}{dt} \cosh t &= \frac{d}{dt} \left( \frac{e^t + e^{-t}}{2} \right) = \frac{(e^t + e^{-t})'}{2} = \frac{e^t - e^{-t}}{2} = \sinh t, \\ \frac{d}{dt} \sinh t &= \frac{d}{dt} \left( \frac{e^t - e^{-t}}{2} \right) = \frac{(e^t - e^{-t})'}{2} = \frac{e^t + e^{-t}}{2} = \cosh t.\end{aligned}$$

- (b) It easily follows from the initial conditions— $\cosh 0 = 1$  and  $\sinh 0 = 0$ —that  $\cosh t$  and  $\sinh t$  are linearly independent on  $-\infty, \infty$ . Indeed, since  $\sinh t$  is not identically zero, neither of them is a constant multiple of the other. By Theorem 2, a general solution to  $y'' - y = 0$  is  $y(t) = c_1 \cosh t + c_2 \sinh t$ .
- (c) Let  $r_1 = \alpha + \beta$  and  $r_2 = \alpha - \beta$  be two real distinct roots of the auxiliary equation  $ar^2 + br + c = 0$ . Then a general solution to  $ay'' + by' + cy = 0$  has the form

$$y = C_1 e^{r_1 t} + C_2 e^{r_2 t} = e^{\alpha t} (C_1 e^{\beta t} + C_2 e^{-\beta t}). \quad (4.1)$$

It follows from the explicit formulas obtained in part (a) that

$$\cosh(\beta t) + \sinh(\beta t) = e^{\beta t}, \quad \cosh(\beta t) - \sinh(\beta t) = e^{-\beta t}.$$

Substituting these expressions into (4.1) yields

$$\begin{aligned}y &= e^{\alpha t} [C_1 (\cosh(\beta t) + \sinh(\beta t)) + C_2 (\cosh(\beta t) - \sinh(\beta t))] \\ &= e^{\alpha t} [(C_1 + C_2) \cosh(\beta t) + (C_1 - C_2) \sinh(\beta t)] = e^{\alpha t} [c_1 \cosh(\beta t) + c_2 \sinh(\beta t)],\end{aligned}$$

where  $c_1 = C_1 + C_2$  and  $c_2 = C_1 - C_2$  are arbitrary constants.

- (d) The auxiliary equation for  $y'' + y' - 6y = 0$ , which is  $r^2 + r - 6 = 0$ , has two real distinct roots  $r = -3, 2$ . Solving the system

$$\begin{cases} \alpha + \beta = -3 \\ \alpha - \beta = 2, \end{cases}$$

we find that  $\alpha = -1/2$ ,  $\beta = -5/2$ . Hence, a general solution is

$$\begin{aligned}y &= e^{-t/2} [c_1 \cosh(-5t/2) + c_2 \sinh(-5t/2)] = e^{-t/2} [c_1 \cosh(5t/2) - c_2 \sinh(5t/2)] \\ \Rightarrow y' &= e^{-t/2} [-(c_1/2) \cosh(5t/2) + (c_2/2) \sinh(5t/2) \\ &\quad + (5c_1/2) \sinh(5t/2) - (5c_2/2) \cosh(5t/2)].\end{aligned}$$

To satisfy the initial conditions, we solve the system

$$\begin{aligned} 2 &= y(0) = c_1 \\ -17/2 &= y'(0) = -(c_1/2) - (5c_2/2) \end{aligned} \quad \Rightarrow \quad \begin{aligned} c_1 &= 2 \\ c_2 &= 3. \end{aligned}$$

Therefore, the answer is

$$y = e^{-t/2} [2 \cosh(5t/2) - 3 \sinh(5t/2)].$$

### EXERCISES 4.3: Auxiliary Equations with Complex Roots

2. The auxiliary equation in this problem is  $r^2 + 1 = 0$ , which has roots  $r = \pm i$ . We see that  $\alpha = 0$  and  $\beta = 1$ . Thus, a general solution to the differential equation is given by

$$y(t) = c_1 e^{(0)t} \cos t + c_2 e^{(0)t} \sin t = c_1 \cos t + c_2 \sin t.$$

4. The auxiliary equation,  $r^2 - 10r + 26 = 0$ , has roots  $r = 5 \pm i$ . So,  $\alpha = 5$ ,  $\beta = 1$ , and

$$y(t) = c_1 e^{5t} \cos t + c_2 e^{5t} \sin t$$

is a general solution.

6. This differential equation has the auxiliary equation  $r^2 - 4r + 7 = 0$ . The roots of this auxiliary equation are  $r = (4 \pm \sqrt{16 - 28})/2 = 2 \pm \sqrt{3}i$ . We see that  $\alpha = 2$  and  $\beta = \sqrt{3}$ . Thus, a general solution to the differential equation is given by

$$w(t) = c_1 e^{2t} \cos(\sqrt{3}t) + c_2 e^{2t} \sin(\sqrt{3}t).$$

8. The auxiliary equation for this problem is given by

$$4r^2 + 4r + 6 = 0 \quad \Rightarrow \quad 2r^2 + 2r + 3 = 0 \quad \Rightarrow \quad r = \frac{-2 \pm \sqrt{4 - 24}}{4} = -\frac{1}{2} \pm \frac{\sqrt{5}}{2}i.$$

Therefore,  $\alpha = -1/2$  and  $\beta = \sqrt{5}/2$ , and a general solution is given by

$$y(t) = c_1 e^{-t/2} \cos\left(\frac{\sqrt{5}t}{2}\right) + c_2 e^{-t/2} \sin\left(\frac{\sqrt{5}t}{2}\right).$$

10. The associated auxiliary equation,  $r^2 + 4r + 8 = 0$ , has two complex roots,  $r = -2 \pm 2i$ .

Thus the answer is

$$y(t) = c_1 e^{-2t} \cos 2t + c_2 e^{-2t} \sin 2t.$$

## Chapter 4

**12.** The auxiliary equation for this problem is  $r^2 + 7 = 0$  with roots  $r = \pm\sqrt{7}i$ . Hence,

$$u(t) = c_1 \cos(\sqrt{7}t) + c_2 \sin(\sqrt{7}t),$$

where  $c_1$  and  $c_2$  are arbitrary constants, is a general solution.

**14.** Solving the auxiliary equation yields complex roots

$$r^2 - 2r + 26 = 0 \quad \Rightarrow \quad r = 1 \pm 5i.$$

So,  $\alpha = 1$ ,  $\beta = 5$ , and a general solution is given by

$$y(t) = c_1 e^t \cos 5t + c_2 e^t \sin 5t.$$

**16.** First, we find the roots of the auxiliary equation.

$$r^2 - 3r - 11 = 0 \quad \Rightarrow \quad r = \frac{3 \pm \sqrt{3^2 - 4(1)(-11)}}{2} = \frac{3 \pm \sqrt{53}}{2}.$$

These are real distinct roots. Hence, a general solution to the given equation is

$$y(t) = c_1 e^{(3+\sqrt{53})t/2} + c_2 e^{(3-\sqrt{53})t/2}.$$

**18.** The auxiliary equation in this problem,  $2r^2 + 13r - 7 = 0$ , has the roots  $r = 1/2, -7$ .

Therefore, a general solution is given by

$$y(t) = c_1 e^{t/2} + c_2 e^{-7t}.$$

**20.** The auxiliary equation,  $r^3 - r^2 + 2 = 0$ , is a cubic equation. Since any cubic equation has a real root, first we examine the divisors of the free coefficient, 2, to find integer real roots (if any). By inspection,  $r = -1$  satisfies the equation. Dividing  $r^3 - r^2 + 2$  by  $r + 1$  yields

$$r^3 - r^2 + 2 = (r + 1)(r^2 - 2r + 2).$$

Therefore, the other two roots of the auxiliary equation are the roots of the quadratic equation  $r^2 - 2r + 2 = 0$ , which are  $r = 1 \pm i$ . A general solution to the given equation is then given by

$$y(t) = c_1 e^{-t} + c_2 e^t \cos t + c_3 e^t \sin t.$$

**22.** The auxiliary equation for this problem is  $r^2 + 2r + 17 = 0$ , which has the roots

$$r = -1 \pm 4i.$$

So, a general solution is given by

$$y(t) = c_1 e^{-t} \cos 4t + c_2 e^{-t} \sin 4t,$$

where  $c_1$  and  $c_2$  are arbitrary constants. To find the solution that satisfies the initial conditions,  $y(0) = 1$  and  $y'(0) = -1$ , we first differentiate the solution and then plug in the given initial conditions into  $y(t)$  and  $y'(t)$  to find  $c_1$  and  $c_2$ . This yields

$$y'(t) = c_1 e^{-t} (-\cos 4t - 4 \sin 4t) + c_2 e^{-t} (-\sin 4t + 4 \cos 4t)$$

and so

$$\begin{aligned} y(0) &= c_1 = 1 \\ y'(0) &= -c_1 + 4c_2 = -1. \end{aligned}$$

Thus  $c_1 = 1$ ,  $c_2 = 0$ , and the solution is given by  $y(t) = e^{-t} \cos 4t$ .

**24.** The auxiliary equation for this problem is  $r^2 + 9 = 0$ . The roots of this equation are  $r = \pm 3i$ , and a general solution is given by  $y(t) = c_1 \cos 3t + c_2 \sin 3t$ , where  $c_1$  and  $c_2$  are arbitrary constants. To find the solution that satisfies the initial conditions,  $y(0) = 1$  and  $y'(0) = 1$ , we solve a system

$$\begin{aligned} y(0) &= (c_1 \cos 3t + c_2 \sin 3t)|_{t=0} = c_1 = 1 \\ y'(0) &= (-3c_1 \sin 3t + 3c_2 \cos 3t)|_{t=0} = 3c_2 = 1. \end{aligned}$$

Solving this system of equations yields  $c_1 = 1$  and  $c_2 = 1/3$ . Thus

$$y(t) = \cos 3t + \frac{\sin 3t}{3}$$

is the desired solution.

**26.** The auxiliary equation,  $r^2 - 2r + 1 = 0$ , has a repeated root  $r = 1$ . Thus, a general solution is

$$y(t) = (c_1 + c_2 t) e^t,$$

## Chapter 4

where  $c_1$  and  $c_2$  are arbitrary constants. To find the solution that satisfies the initial conditions,  $y(0) = 1$  and  $y'(0) = -2$ , we find  $y'(t) = (c_1 + c_2 + c_2t)e^t$  and solve the system

$$\begin{aligned}1 &= y(0) = c_1 \\ -2 &= y'(0) = c_1 + c_2.\end{aligned}$$

This yields  $c_1 = 1$ ,  $c_2 = -2 - c_1 = -3$ . So, the answer is

$$y(t) = (1 - 3t)e^t.$$

- 28.** Let  $b = 5$ . Then the given equation becomes  $y'' + 5y' + 4y = 0$ . The auxiliary equation,  $r^2 + 5r + 4 = 0$ , has two real distinct roots  $r = -1, -4$ . Thus, a general solution is

$$y = c_1e^{-t} + c_2e^{-4t} \quad \Rightarrow \quad y' = -c_1e^{-t} - 4c_2e^{-4t}.$$

Substituting the initial conditions yields

$$\begin{aligned}1 &= y(0) = c_1 + c_2 \\ 0 &= y'(0) = -c_1 - 4c_2.\end{aligned}$$

Thus,  $c_1 = 4/3$ ,  $c_2 = -1/3$ , and

$$y = \frac{4e^{-t} - e^{-4t}}{3}$$

is the solution to the given initial value problem.

With  $b = 4$ , the auxiliary equation is  $r^2 + 4r + 4 = 0$ , having a double root  $r = -2$ .

Hence, a general solution is given by

$$y = (c_1 + c_2t)e^{-2t} \quad \Rightarrow \quad y' = (c_2 - 2c_1 - 2c_2t)e^{-2t}.$$

Substituting the initial conditions, we obtain

$$\begin{aligned}1 &= y(0) = c_1 \\ 0 &= y'(0) = -2c_1 + c_2.\end{aligned}$$

Thus,  $c_1 = 1$ ,  $c_2 = 2$ , and

$$y = (1 + 2t)e^{-2t}$$

is the solution to the given initial value problem for  $b = 4$ .

Finally, if  $b = 2$ , our equation has the characteristic equation  $r^2 + 2r + 4 = 0$ , with complex roots  $r = -1 \pm \sqrt{3}i$ . Thus, a general solution is given by

$$\begin{aligned} y &= e^{-t} \left[ c_1 \cos(\sqrt{3}t) + c_2 \sin(\sqrt{3}t) \right] \quad \Rightarrow \\ y' &= e^{-t} \left[ (-c_1 + \sqrt{3}c_2) \cos(\sqrt{3}t) - (\sqrt{3}c_1 + c_2) \sin(\sqrt{3}t) \right], \end{aligned}$$

and we have a system

$$\begin{aligned} 1 &= y(0) = c_1 \\ 0 &= y'(0) = -c_1 + \sqrt{3}c_2. \end{aligned}$$

Solving, we get  $c_1 = 1$ ,  $c_2 = 1/\sqrt{3}$ , and  $y = e^{-t} [\cos(\sqrt{3}t) + (1/\sqrt{3}) \sin(\sqrt{3}t)]$ .

The graphs of the solutions, corresponding to  $b = 5$ ,  $4$ , and  $2$ , are shown in Fig. 4–C on page 174.

**30.** Applying the product rule yields

$$\begin{aligned} \frac{de^{(\alpha+i\beta)t}}{dt} &= \frac{d}{dt} [e^{\alpha t} (\cos \beta t + i \sin \beta t)] \\ &= \alpha e^{\alpha t} (\cos \beta t + i \sin \beta t) + e^{\alpha t} (-\beta \sin \beta t + i\beta \cos \beta t) \\ &= e^{\alpha t} [(\alpha + i\beta) \cos \beta t + (i\alpha - \beta) \sin \beta t] \\ &= e^{\alpha t} [(\alpha + i\beta) \cos \beta t + i(\alpha + i\beta) \sin \beta t] \\ &= (\alpha + i\beta) e^{\alpha t} (\cos \beta t + i \sin \beta t) = (\alpha + i\beta) e^{(\alpha+i\beta)t}. \end{aligned}$$

**32. (a)** We want to determine the equation of motion for a spring system with  $m = 10$  kg,  $b = 0$ ,  $k = 250$  kg/sec<sup>2</sup>,  $y(0) = 0.3$  m, and  $y'(0) = -0.1$  m/sec. That is, we seek the solution to the initial value problem

$$10y''(t) + 250y(t) = 0; \quad y(0) = 0.3, \quad y'(0) = -0.1.$$

The auxiliary equation for the above differential equation is

$$10r^2 + 250 = 0 \quad \Rightarrow \quad r^2 + 25 = 0,$$

which has the roots  $r \pm 5i$ . Hence  $\alpha = 0$  and  $\beta = 5$ , and the displacement  $y(t)$  has the form

$$y(t) = c_1 \cos 5t + c_2 \sin 5t.$$



## Chapter 4

We find  $c_1$  and  $c_2$  by using the initial conditions. We first differentiate  $y(t)$  to get

$$y'(t) = -5c_1 \sin 5t + 5c_2 \cos 5t.$$

Substituting  $y(t)$  and  $y'(t)$  into the initial conditions, we obtain the system

$$\begin{aligned}y(0) &= 0.3 = c_1 \\y'(0) &= -0.1 = 5c_2.\end{aligned}$$

Solving, we find that  $c_1 = 0.3$  and  $c_2 = -0.02$ . Therefore the equation of motion is given by

$$y(t) = 0.3 \cos 5t - 0.02 \sin 5t \text{ (m)}.$$

(b) In part (a) we found that  $\beta = 5$ . Therefore the frequency of oscillation is  $5/(2\pi)$ .

**34.** For the specified values of the inductance  $L$ , resistance  $R$ , capacitance  $C$ , electromotive force  $E(t)$ , and initial values  $q_0$  and  $I_0$ , the initial value problem (20) becomes

$$10 \frac{dI}{dt} + 20I + 6260q = 100; \quad q(0) = 0, \quad I(0) = 0.$$

In particular, substituting  $t = 0$ , we conclude that

$$10I'(0) + 20I(0) + 6260q(0) = 100 \quad \Rightarrow \quad I'(0) = 10.$$

Differentiating the above equation, using the relation  $I = dq/dt$ , and simplifying, yields an initial value problem

$$I'' + 2I' + 626I = 0; \quad I(0) = 0, \quad I'(0) = 10.$$

The auxiliary equation for this homogeneous second order equation,  $r^2 + 2r + 626 = 0$ , has roots  $r = -1 \pm 25i$ . Thus, a general solution has the form

$$I(t) = e^{-t} (c_1 \cos 25t + c_2 \sin 25t).$$

Since

$$I'(t) = e^{-t} [(-c_1 + 25c_2) \cos 25t + (-25c_1 - c_2) \sin 25t],$$

for  $c_1$  and  $c_2$  we have a system of equations

$$I(0) = c_1 = 0$$

$$I'(0) = -c_1 + 25c_2 = 10.$$

Hence,  $c_1 = 0$ ,  $c_2 = 0.4$ , and the current at time  $t$  is given by

$$I(t) = 0.4e^{-t} \sin 25t.$$

**36. (a)** The auxiliary equation for Problem 21 is  $r^2 + 2r + 2 = 0$ , which has the roots

$$r = \frac{-2 \pm \sqrt{4 - 8}}{2} = -1 \pm i.$$

Thus, (21) gives a general solution of the form

$$y(t) = d_1 e^{(-1+i)t} + d_2 e^{(-1-i)t}.$$

The differentiation formula (7) for complex exponential function yields

$$y'(t) = (-1 + i)d_1 e^{(-1+i)t} + (-1 - i)d_2 e^{(-1-i)t}.$$

Therefore, for  $d_1$  and  $d_2$  we obtain a system

$$y(0) = d_1 + d_2 = 2$$

$$y'(0) = (-1 + i)d_1 + (-1 - i)d_2 = 1.$$

Multiplying the first equation by  $(1+i)$  and adding the result to the second equation yields

$$2id_1 = 3 + 2i \quad \Rightarrow \quad d_1 = 1 - \frac{3i}{2} \quad \Rightarrow \quad d_2 = 2 - d_1 = 1 + \frac{3i}{2},$$

and a complex form of the solution is

$$y(t) = \left(1 - \frac{3i}{2}\right) e^{(-1+i)t} + \left(1 + \frac{3i}{2}\right) e^{(-1-i)t}.$$

A general solution, given by (9), is

$$y(t) = c_1 e^{-t} \cos t + c_2 e^{-t} \sin t,$$

where  $c_1$  and  $c_2$  are arbitrary constants. To find the solution that satisfies the initial conditions,  $y(0) = 2$  and  $y'(0) = 1$ , we first differentiate the solution found above, then plug in given initial conditions. This yields

$$y'(t) = c_1 e^{-t} (-\cos t - \sin t) + c_2 e^{-t} (\cos t - \sin t)$$

## Chapter 4

and

$$\begin{aligned}y(0) &= c_1 = 2 \\y'(0) &= -c_1 + c_2 = 1.\end{aligned}$$

Thus  $c_1 = 2$ ,  $c_2 = 3$ , and

$$y(t) = 2e^{-t} \cos t + 3e^{-t} \sin t.$$

To verify that this form of the solution is equivalent to the complex form, obtained using (21), we apply (6) to the latter and simplify.

$$\begin{aligned}\left(1 - \frac{3i}{2}\right) e^{(-1+i)t} &+ \left(1 + \frac{3i}{2}\right) e^{(-1-i)t} \\&= e^{-t} \left[ \left(1 - \frac{3i}{2}\right) (\cos t + i \sin t) + \left(1 + \frac{3i}{2}\right) (\cos t - i \sin t) \right] \\&= e^{-t} (2 \cos t + 3 \sin t).\end{aligned}$$

(b) If  $y(t)$  in (21) is a real-valued function, then, for any  $t$ ,

$$y(t) = \overline{y(t)} = \overline{d_1 e^{(\alpha+i\beta)t} + d_2 e^{(\alpha-i\beta)t}} = \overline{d_1} e^{(\alpha-i\beta)t} + \overline{d_2} e^{(\alpha+i\beta)t}.$$

Therefore,

$$\begin{aligned}0 &\equiv y(t) - \overline{y(t)} = (d_1 - \overline{d_2}) e^{(\alpha+i\beta)t} + (d_2 - \overline{d_1}) e^{(\alpha-i\beta)t} \\&\Rightarrow (d_1 - \overline{d_2}) e^{2i\beta t} \equiv \overline{d_1} - d_2.\end{aligned}$$

Since  $\beta \neq 0$ , this is possible if and only if  $d_1 - \overline{d_2} = 0$  or  $d_1 = \overline{d_2}$ .

**38. (a)** Fixed  $x$ , consider the function  $f(t) := \sin(x+t)$ . Differentiating  $f(t)$  twice yields

$$\begin{aligned}f'(t) &= \frac{d[\sin(x+t)]}{dt} = \cos(x+t) \frac{d(x+t)}{dt} = \cos(x+t), \\f''(t) &= \frac{d[\cos(x+t)]}{dt} = -\sin(x+t) \frac{d(x+t)}{dt} = -\sin(x+t).\end{aligned}$$

Thus,  $f''(t) + f(t) = -\sin(x+t) + \sin(x+t) = 0$ . In addition,  $f(0) = \sin x$ ,  $f'(0) = \cos x$ . Therefore,  $f(t)$  is the solution to the initial value problem

$$y'' + y = 0, \quad y(0) = \sin x, \quad y'(0) = \cos x. \quad (4.2)$$

- (b) The auxiliary equation for the differential equation in (4.2) is  $r^2 + 1 = 0$ , which has two imaginary roots  $r = \pm i$ . Therefore, a general solution is given by

$$y(t) = c_1 \cos t + c_2 \sin t.$$

We now find constants  $c_1$  and  $c_2$  so that  $y(t)$  satisfies the initial conditions in (4.2).

$$\begin{aligned} \sin x = y(0) &= c_1, \\ \cos x = y'(0) &= (-c_1 \sin t + c_2 \cos t) \Big|_{t=0} = c_2. \end{aligned}$$

Therefore,  $y(t) = \sin x \cos t + \cos x \sin t$ .

- (c) By Theorem 1, Section 4.2, the solution to the initial value problem (4.2) is unique. Thus,  $y(t)$  found in part (b) must be  $f(t)$  meaning that

$$\sin(x + t) = \sin x \cos t + \cos x \sin t.$$

#### EXERCISES 4.4: Nonhomogeneous Equations: The Method of Undetermined Coefficients

2. The method of undetermined coefficients can be used to find a particular solution in the form (15) with  $m = 3$ ,  $\alpha = 0$ , and  $\beta = 4$ .

4. Writing

$$\frac{\sin x}{e^{4x}} = e^{-4x} \sin x,$$

we see that the right-hand side is of the form, for which (15) applies.

6. The nonhomogeneous term simplifies to

$$f(x) = 4x \sin^2 x + 4x \cos^2 x = 4x (\sin^2 x + \cos^2 x) = 4x.$$

Therefore, the method of undetermined coefficients can be used, and a particular solution has the form (14) with  $m = 1$  and  $r = 0$ .

8. Yes, one can use the method of undetermined coefficients because the right-hand side of the given equation is exactly of the form, for which (15) applies.
10. Since  $r = 0$  is not a root of the auxiliary equation,  $r^2 + 2r - 1 = 0$ , we choose  $s = 0$  in (14) and seek a particular solution of the form  $y_p(t) \equiv A_0$ . Substitution into the original equation yields

$$(A_0)'' + 2(A_0)' - A_0 = 10 \quad \Rightarrow \quad A_0 = -10.$$

## Chapter 4

Thus,  $y_p(t) \equiv -10$  is a particular solution to the given nonhomogeneous equation.

- 12.** The associated auxiliary equation,  $2r + 1 = 0$ , has the root  $r = -1/2 \neq 0$ . So, we take  $s = 0$  in (14) and look for a particular solution to the nonhomogeneous equation of the form

$$x_p(t) = A_2 t^2 + A_1 t + A_0$$

Substitution into the original differential equation yields

$$2x_p'(t) + x_p(t) = 2(2A_2 t + A_1) + A_2 t^2 + A_1 t + A_0 = A_2 t^2 + (4A_2 + A_1)t + (2A_1 + A_0) = 3t^2.$$

By equating coefficients we obtain

$$\begin{array}{rcl} A_2 = 3 & & A_2 = 3 \\ 4A_2 + A_1 = 0 & \Rightarrow & A_1 = -4A_2 = -12 \\ 2A_1 + A_0 = 0 & & A_0 = -2A_1 = 24. \end{array}$$

Therefore,  $x_p(t) = 3t^2 - 12t + 24$ .

- 14.** The auxiliary equation,  $r^2 + 1 = 0$ , has imaginary solutions  $r = \pm i$ , and the nonhomogeneous term can be written as  $2^x = e^{(\ln 2)x}$ . Therefore, we take the form (14) with  $m = 0$ ,  $r = \ln 2$ , and  $s = 0$ .

$$y_p = A_0 2^x \quad \Rightarrow \quad y_p' = A_0 (\ln 2) 2^x \quad \Rightarrow \quad y_p'' = A_0 (\ln 2)^2 2^x.$$

Substitution into the original equation yields

$$y_p'' + y_p = A_0 (\ln 2)^2 2^x + A_0 2^x = A_0 [(\ln 2)^2 + 1] 2^x = 2^x.$$

Thus,  $A_0 = [(\ln 2)^2 + 1]^{-1}$ , and so  $y_p(x) = [(\ln 2)^2 + 1]^{-1} 2^x$ .

- 16.** The corresponding homogeneous equation has the auxiliary equation  $r^2 - 1 = 0$ , whose roots are  $r = \pm 1$ . Thus, in the expression  $\theta_p(t) = (A_1 t + A_0) \cos t + (B_1 t + B_0) \sin t$  none of the terms is a solution to the homogeneous equation. We find

$$\begin{aligned} \theta_p(t) &= (A_1 t + A_0) \cos t + (B_1 t + B_0) \sin t \\ \Rightarrow \theta_p'(t) &= A_1 \cos t - (A_1 t + A_0) \sin t + B_1 \sin t + (B_1 t + B_0) \cos t \\ &= (B_1 t + A_1 + B_0) \cos t + (-A_1 t - A_0 + B_1) \sin t \\ \Rightarrow \theta_p''(t) &= B_1 \cos t - (B_1 t + B_0 + A_1) \sin t - A_1 \sin t + (-A_1 t - A_0 + B_1) \cos t \end{aligned}$$

$$= (-A_1 t - A_0 + B_1) \cos t + (-B_1 t - B_0 - 2A_1) \sin t.$$

Substituting these expressions into the original differential equation, we get

$$\begin{aligned} \theta_p'' - \theta_p &= (-A_1 t - A_0 + 2B_1) \cos t + (-B_1 t - B_0 - 2A_1) \sin t \\ &\quad - (A_1 t + A_0) \cos t - (B_1 t + B_0) \sin t \\ &= -2A_1 t \cos t + (-2A_0 + 2B_1) \cos t - 2B_1 t \sin t + (-2A_1 - 2B_0) \sin t = t \sin t. \end{aligned}$$

Equating the coefficients, we see that

$$\begin{array}{rcl} -2A_1 = 0 & & A_1 = 0 \\ -2A_0 + 2B_1 = 0 & \Rightarrow & A_0 = B_1 = -1/2 \\ -2B_1 = 1 & & B_1 = -1/2 \\ -2A_1 - 2B_0 = 0 & & B_0 = -A_1 = 0. \end{array}$$

Therefore, a particular solution of the nonhomogeneous equation  $\theta'' - \theta = t \sin t$  is given by  $\theta_p(t) = -(t \sin t + \cos t)/2$ .

- 18.** Solving the auxiliary equation,  $r^2 + 4 = 0$ , yields  $r = \pm 2i$ . Therefore, we seek a particular solution of the form (15) with  $m = 0$ ,  $\alpha = 0$ ,  $\beta = 2$ , and take  $s = 1$  since  $\alpha + i\beta = 2i$  is a root of the auxiliary equation. Hence,

$$\begin{aligned} y_p &= A_0 t \cos 2t + B_0 t \sin 2t, \\ y_p' &= (2B_0 t + A_0) \cos 2t + (-2A_0 t + B_0) \sin 2t, \\ y_p'' &= (-4A_0 t + 4B_0) \cos 2t + (-4B_0 t - 4A_0) \sin 2t; \\ y_p'' + 4y_p &= 4B_0 \cos 2t - 4A_0 \sin 2t = 8 \sin 2t. \end{aligned}$$

Equating coefficients yields  $A_0 = -2$ ,  $B_0 = 0$ . Hence,  $y_p(t) = -2t \cos 2t$ .

- 20.** Similarly to Problem 18, we seek a particular solution of the form

$$\begin{aligned} y_p &= t(A_1 t + A_0) \cos 2t + t(B_1 t + B_0) \sin 2t \\ &= (A_1 t^2 + A_0 t) \cos 2t + (B_1 t^2 + B_0 t) \sin 2t. \end{aligned}$$

Differentiating, we get

$$\begin{aligned} y_p' &= [2B_1 t^2 + (2A_1 + 2B_0)t + A_0] \cos 2t + [-2A_1 t^2 + (-2A_0 + 2B_1)t + B_0] \sin 2t, \\ y_p'' &= [-4A_1 t^2 + (-4A_0 + 8B_1)t + (2A_1 + 4B_0)] \cos 2t \end{aligned}$$

## Chapter 4

$$+ [-4B_1t^2 + (-8A_1 - 4B_0)t + (-4A_0 + 2B_1)] \sin 2t.$$

We now substitute  $y_p$  and  $y_p''$  into the given equation and simplify.

$$y_p'' + 4y_p = [8B_1t + (2A_1 + 4B_0)] \cos 2t + [-8A_1t + (-4A_0 + 2B_1)] \sin 2t = 16t \sin 2t.$$

Therefore,

$$\begin{array}{rcl} 8B_1 = 0 & & B_1 = 0 \\ 2A_1 + 4B_0 = 0 & \Rightarrow & B_0 = -A_1/2 = 1 \\ -8A_1 = 16 & & A_1 = -2 \\ -4A_0 + 2B_1 = 0 & & A_0 = B_1/2 = 0 \end{array}$$

and  $y_p = -2t^2 \cos 2t + t \sin 2t$ .

- 22.** The nonhomogeneous term of the original equation is  $24t^2e^t$ . Therefore, a particular solution has the form  $x_p(t) = t^s (A_2t^2 + A_1t + A_0) e^t$ . The corresponding homogeneous differential equation has the auxiliary equation  $r^2 - 2r + 1 = (r - 1)^2 = 0$ . Since  $r = 1$  is its double root,  $s$  is chosen to be 2, and a particular solution to the nonhomogeneous equation has the form

$$x_p(t) = t^2 (A_2t^2 + A_1t + A_0) e^t = (A_2t^4 + A_1t^3 + A_0t^2) e^t.$$

We compute

$$\begin{aligned} x_p' &= [A_2t^4 + (4A_2 + A_1)t^3 + (3A_1 + A_0)t^2 + 2A_0t] e^t, \\ x_p'' &= [A_2t^4 + (8A_2 + A_1)t^3 + (12A_2 + 6A_1 + A_0)t^2 + (6A_1 + 4A_0)t + 2A_0] e^t. \end{aligned}$$

Substituting these expressions into the original differential equation yields

$$x_p'' - 2x_p' + x_p = [12A_2t^2 + 6A_1t + 2A_0] e^t = 24t^2e^t.$$

Equating coefficients yields  $A_1 = A_0 = 0$  and  $A_2 = 2$ . Therefore,  $x_p(t) = 2t^4e^t$ .

- 24.** In (15), we take  $s = 1$  since  $\alpha + i\beta = i$  is a root of auxiliary equation. Thus,

$$\begin{aligned} y_p &= (A_1x^2 + A_0x) \cos x + (B_1x^2 + B_0x) \sin x, \\ y_p' &= [B_1x^2 + (B_0 + 2A_1)x + A_0] \cos x + [-A_1x^2 + (2B_1 - A_0)x + B_0] \sin x, \\ y_p'' &= [-A_1x^2 + (4B_1 - A_0)x + 2(B_0 + A_1)] \cos x \\ &\quad + [-B_1x^2 + (-4A_1 - B_0)x + 2(B_1 - A_0)] \sin x. \end{aligned}$$

Substitution yields

$$y'' + y = [4B_1x + 2(B_0 + A_1)] \cos x + [-4A_1x + 2(B_1 - A_0)] \sin x = 4x \cos x.$$

So,

$$\begin{array}{rcl} 4B_1 = 4 & & B_1 = 1 \\ 2(B_0 + A_1) = 0 & \Rightarrow & B_0 = -A_1 = 0 \\ -A_1 = 0 & & A_1 = 0 \\ 2(B_1 - A_0) = 0 & & A_0 = B_1 = 1 \end{array}$$

and

$$y_p(x) = x \cos x + x^2 \sin x.$$

- 26.** In the nonhomogeneous term,  $4te^{-t} \cos t$ ,  $\alpha = -1$ ,  $\beta = 1$ , and  $m = 1$ . We choose  $s = 1$  in (15) since  $\alpha + i\beta = -1 + i$  is a root of the auxiliary equation. Thus,  $y_p$  has the form

$$\begin{aligned} y_p(t) &= t[(A_1t + A_0) \cos t + (B_1t + B_0) \sin t] e^{-t} \\ &= [(A_1t^2 + A_0t) \cos t + (B_1t^2 + B_0t) \sin t] e^{-t} \end{aligned}$$

If we compute now  $y'_p$ ,  $y''_p$ , substitute into the given equation, we will find unknown coefficients. A technical difficulty, that one faces, is time consuming differentiation. To simplify this procedure, we employ complex numbers noting that  $y_p$  is the real part of  $z_p = (C_1t^2 + C_0t) e^{(-1+i)t}$ , where  $C_1 = A_1 - B_1i$  and  $C_0 = A_0 - B_0i$ . Since the differentiation operator is linear and our equation has real coefficients,  $z_p$  must satisfy

$$\operatorname{Re}(z''_p + 2z'_p + 2z_p) = 4te^{-t} \cos t.$$

Differentiating, we get

$$\begin{aligned} z'_p &= [C_1(-1+i)t^2 + (2C_1 + C_0(-1+i))t + C_0] e^{(-1+i)t}, \\ z''_p &= [C_1(-1+i)^2t^2 + (4C_1(-1+i) + C_0(-1+i)^2)t + 2C_1 + 2C_0(-1+i)] e^{(-1+i)t}. \end{aligned}$$

Substitution yields

$$\begin{aligned} \operatorname{Re}(z''_p + 2z'_p + 2z_p) &= \operatorname{Re}[(4C_1ti + 2C_1 + 2C_0i) e^{(-1+i)t}] = 4te^{-t} \cos t \\ \Rightarrow \operatorname{Re}[(4C_1ti + 2C_1 + 2C_0i) e^{it}] &= 4t \cos t \\ \Rightarrow (4B_1t + 2A_1 + 2B_0) \cos t - (4A_1t - 2B_1 + 2A_0) \sin t &= 4t \cos t. \end{aligned}$$



## Chapter 4

Thus,

$$\begin{array}{rcl} 4B_1 = 4 & & B_1 = 1 \\ 2A_1 + 2B_0 = 0 & \Rightarrow & B_0 = -A_1 = 0 \\ 4A_1 = 0 & & A_1 = 0 \\ 2A_0 - 2B_1 = 0 & & A_0 = B_1 = 1 \end{array}$$

and  $y_p = (t \cos t + t^2 \sin t) e^{-t}$ .

**28.** The right-hand side of this equation suggests that

$$y_p(t) = t^s (A_4 t^4 + A_3 t^3 + A_2 t^2 + A_1 t + A_0) e^t.$$

Since  $r = 1$  is not a root of the auxiliary equation,  $r^2 + 3r - 7 = 0$ , we take  $s = 0$ . Thus

$$y_p(t) = (A_4 t^4 + A_3 t^3 + A_2 t^2 + A_1 t + A_0) e^t.$$

**30.** Here,  $\alpha + i\beta = 1 + i$  is not a root of the associated equation,  $r^2 - 2r + 1 = (r - 1)^2 = 0$ . Therefore, a particular solution has the form

$$y_p(t) = (A_0 \cos t + B_0 \sin t) e^t.$$

**32.** From the form of the right-hand side, we conclude that a particular solution should be of the form

$$y_p(t) = t^s (A_6 t^6 + A_5 t^5 + A_4 t^4 + A_3 t^3 + A_2 t^2 + A_1 t + A_0) e^{-3t}.$$

Since  $r = -3$  is a simple root of the auxiliary equation, we take  $s = 1$ . Therefore,

$$y_p(t) = (A_6 t^7 + A_5 t^6 + A_4 t^5 + A_3 t^4 + A_2 t^3 + A_1 t^2 + A_0 t) e^{-3t}.$$

**34.** The right-hand side of the equation suggests that  $y_p(t) = A_0 t^s e^{-t}$ . By inspection, we see that  $r = -1$  is not a root of the corresponding auxiliary equation,  $2r^3 + 3r^2 + r - 4 = 0$ . Thus, with  $s = 0$ ,

$$\begin{aligned} y_p = A_0 e^{-t} &\Rightarrow y'_p = -A_0 e^{-t} \Rightarrow y''_p = A_0 e^{-t} \Rightarrow y'''_p = -A_0 e^{-t} \\ \Rightarrow 2y'''_p + 3y''_p + y'_p - 4y_p &= -4A_0 e^{-t} = e^{-t}. \end{aligned}$$

Therefore,  $A_0 = -1/4$  and  $y_p(t) = -e^{-t}/4$ .

- 36.** We look for a particular solution of the form  $y_p(t) = t^s(A_0 \cos t + B_0 \sin t)$ , and choose  $s = 0$ , because  $i$  is not a root of the auxiliary equation,  $r^4 - 3r^2 - 8 = 0$ . Hence,

$$\begin{aligned} y_p(t) &= A_0 \cos t + B_0 \sin t \\ \Rightarrow y'_p(t) &= -B_0 \cos t + A_0 \sin t \\ \Rightarrow y''_p(t) &= B_0 \sin t + A_0 \cos t \\ \Rightarrow y'''_p(t) &= A_0 \sin t - B_0 \cos t \\ \Rightarrow y_p^{(4)}(t) &= A_0 \cos t + B_0 \sin t. \end{aligned}$$

Hence,

$$\begin{aligned} y_p^{(4)} - 3y_p'' - 8y_p &= -4A_0 \cos t - 4B_0 \sin t = \sin t \\ \Rightarrow A_0 = 0, \quad B_0 = -\frac{1}{4} &\Rightarrow y_p(t) = -\frac{\sin t}{4}. \end{aligned}$$

### EXERCISES 4.5: The Superposition Principle and Undetermined Coefficients Revisited

- 2.** Let  $g_1(t) := \cos 2t$  and  $g_2(t) := t$ . Then  $y_1(t) = (1/4) \sin 2t$  is a solution to

$$y'' + 2y' + 4y = g_1(t)$$

and  $y_2(t) = t/4 - 1/8$  is a solution to

$$y'' + 2y' + 4y = g_2(t).$$

- (a) The right-hand side of the given equation equals  $g_2(t) + g_1(t)$ . Therefore, the function  $y(t) = y_2(t) + y_1(t) = t/4 - 1/8 + (1/4) \sin 2t$  is a solution to the equation  $y'' + 2y' + 4y = t + \cos 2t$ .
- (b) We can express  $2t - 3 \cos 2t = 2g_2(t) - 3g_1(t)$ . So, by the superposition principle, the desired solution is  $y(t) = 2y_2(t) - 3y_1(t) = t/2 - 1/4 - (3/4) \sin 2t$ .
- (c) Since  $11t - 12 \cos 2t = 11g_2(t) - 12g_1(t)$ , the function

$$y(t) = 11y_2(t) - 12y_1(t) = 11t/4 - 11/8 - 3 \sin 2t$$

is a solution to the given equation.

## Chapter 4

4. The corresponding homogeneous equation,  $y'' + y' = 0$ , has the associated auxiliary equation  $r^2 + r = r(r + 1) = 0$ . This gives  $r = 0, -1$ , and a general solution to the homogeneous equation is  $y_h(t) = c_1 + c_2e^{-t}$ . Combining this solution with the particular solution,  $y_p(t) = t$ , we find that a general solution is given by

$$y(t) = y_p(t) + y_h(t) = t + c_1 + c_2e^{-t}.$$

6. The corresponding auxiliary equation,  $r^2 + 5r + 6 = 0$ , has the roots  $r = -3, -2$ . Therefore, a general solution to the corresponding homogeneous equation has the form  $y_h(x) = c_1e^{-2x} + c_2e^{-3x}$ . By the superposition principle, a general solution to the original nonhomogeneous equation is

$$y(x) = y_p(x) + y_h(x) = e^x + x^2 + c_1e^{-2x} + c_2e^{-3x}.$$

8. First, we rewrite the equation in standard form, that is,

$$y'' - 2y = 2 \tan^3 x.$$

The corresponding homogeneous equation,  $y'' - 2y = 0$ , has the associated auxiliary equation  $r^2 - 2 = 0$ . Thus  $r = \pm\sqrt{2}$ , and a general solution to the homogeneous equation is

$$y_h(x) = c_1e^{\sqrt{2}x} + c_2e^{-\sqrt{2}x}.$$

Combining this with the particular solution,  $y_p(x) = \tan x$ , we find that a general solution is given by

$$y(x) = y_p(x) + y_h(x) = \tan x + c_1e^{\sqrt{2}x} + c_2e^{-\sqrt{2}x}.$$

10. We can write the nonhomogeneous term as a difference

$$(e^t + t)^2 = e^{2t} + 2te^t + t^2 = g_1(t) + g_2(t) + g_3(t).$$

The functions  $g_1(t)$ ,  $g_2(t)$ , and  $g_3(t)$  have a form suitable for the method of undetermined coefficients. Therefore, we can apply this method to find particular solutions  $y_{p,1}(t)$ ,  $y_{p,2}(t)$ , and  $y_{p,3}(t)$  to

$$y'' - y' + y = g_k(t), \quad k = 1, 2, 3,$$

respectively. Then, by the superposition principle,  $y_p(t) = y_{p,1}(t) + y_{p,2}(t) + y_{p,3}(t)$  is a particular solution to the given equation.

12. This equation is not an equation with constant coefficients. The method of undetermined coefficients cannot be applied because of  $ty$  term.

14. Since, by the definition of  $\cosh t$ ,

$$\cosh t = \frac{e^t + e^{-t}}{2} = \frac{1}{2}e^t + \frac{1}{2}e^{-t},$$

and the method of undetermined coefficients can be applied to each term in this sum, by the superposition principle, the answer is “yes”.

16. The first two terms in the right-hand side fit the form, for which (14) applies. The last term,  $10^t = e^{(\ln 10)t}$ , is of the form, for which (13) can be used. Thus, the answer is “yes”.

18. The auxiliary equation in this problem is  $r^2 - 2r - 3 = 0$  with roots  $r = 3, -1$ . Hence,

$$y_h(t) = c_1e^{3t} + c_2e^{-t}$$

is a general solution to the corresponding homogeneous equation. We now find a particular solution  $y_p(t)$  to the original nonhomogeneous equation. The method of undetermined coefficients yields

$$\begin{aligned} y_p(t) = A_2t^2 + A_1t + A_0 &\Rightarrow y_p'(t) = 2A_2t + A_1 &\Rightarrow y_p''(t) = 2A_2; \\ y_p'' - 2y_p' - 3y_p = (2A_2) - 2(2A_2t + A_1) - 3(A_2t^2 + A_1t + A_0) &= 3t^2 - 5 \\ \Rightarrow -3A_2t^2 + (-4A_2 - 3A_1)t + (2A_2 - 2A_1 - 3A_0) &= 3t^2 - 5 \\ \Rightarrow A_2 = -1, \quad A_1 = -4A_2/3 = 4/3, \quad A_0 = (5 + 2A_2 - 2A_1)/3 &= 1/9. \end{aligned}$$

By the superposition principle, a general solution is given by

$$y(t) = y_p(t) + y_h(t) = -t^2 + \frac{4t}{3} + \frac{1}{9} + c_1e^{3t} + c_2e^{-t}.$$

20. Solving the auxiliary equation,  $r^2 + 4 = 0$ , we find that  $r = \pm 2i$ . Therefore, a general solution to the homogeneous equation,  $y'' + 4y = 0$ , is

$$y_h(\theta) = c_1 \cos 2\theta + c_2 \sin 2\theta.$$

By the method of undetermined coefficients, a particular solution  $y_p(\theta)$  to the original equation has the form  $y_p(\theta) = \theta^s(A_0 \cos \theta + B_0 \sin \theta)$ . We choose  $s = 0$  because  $r = i$  is not a root of the auxiliary equation. So,

$$y_p(\theta) = A_0 \cos \theta + B_0 \sin \theta$$

## Chapter 4

$$\begin{aligned}\Rightarrow y_p'(\theta) &= B_0 \cos \theta - A_0 \sin \theta \\ \Rightarrow y_p''(\theta) &= -A_0 \cos \theta - B_0 \sin \theta.\end{aligned}$$

Substituting these expressions into the equation, we compare the corresponding coefficients and find  $A_0$  and  $B_0$ .

$$\begin{aligned}y_p'' + 4y_p &= 3A_0 \cos \theta + 3B_0 \sin \theta = \sin \theta - \cos \theta \\ \Rightarrow A_0 = -\frac{1}{3}, \quad B_0 = \frac{1}{3} &\Rightarrow y_p(\theta) = \frac{\sin \theta - \cos \theta}{3}.\end{aligned}$$

Therefore,

$$y(\theta) = \frac{\sin \theta - \cos \theta}{3} + c_1 \cos 2\theta + c_2 \sin 2\theta$$

is a general solution to the given nonhomogeneous equation.

- 22.** Since the roots of the auxiliary equation, which is  $r^2 + 6r + 10 = 0$ , are  $r = -3 \pm i$ , we have a general solution to the corresponding homogeneous equation

$$y_h(x) = c_1 e^{-3x} \cos x + c_2 e^{-3x} \sin x = (c_1 \cos x + c_2 \sin x) e^{-3x},$$

and look for a particular solution of the form

$$y_p(x) = A_4 x^4 + A_3 x^3 + A_2 x^2 + A_1 x + A_0.$$

Differentiating  $y_p(x)$ , we get

$$\begin{aligned}y_p'(x) &= 4A_4 x^3 + 3A_3 x^2 + 2A_2 x + A_1, \\ y_p''(x) &= 12A_4 x^2 + 6A_3 x + 2A_2.\end{aligned}$$

Therefore,

$$\begin{aligned}y_p'' + 6y_p' + 10y_p &= 10A_4 x^4 + (10A_3 + 24A_4) x^3 + (10A_2 + 18A_3 + 12A_4) x^2 \\ &\quad + (10A_1 + 12A_2 + 6A_3) x + (10A_0 + 6A_1 + 2A_2) \\ &= 10x^4 + 24x^3 + 2x^2 - 12x + 18.\end{aligned}$$

Hence,  $A_4 = 1$ ,  $A_3 = 0$ ,  $A_2 = -1$ ,  $A_1 = 0$ , and  $A_0 = 2$ . A general solution is given by

$$y(x) = y_p(x) + y_h(x) = x^4 - x^2 + 2 + (c_1 \cos x + c_2 \sin x) e^{-3x}.$$

24. The auxiliary equation,  $r^2 = 0$ , has a double root  $r = 0$ . Therefore,

$$y_h(t) = c_1 + c_2t,$$

and a particular solution to the given equation has the form  $y_p = t^2(A_1t + A_0)$ . Differentiating twice, we obtain

$$y_p'' = 6A_1t + 2A_0 = 6t \quad \Rightarrow \quad A_1 = 1, \quad A_0 = 0,$$

and a general solution to the given equation is

$$y = c_1 + c_2t + t^3.$$

From the initial conditions, we determine constants  $c_1$  and  $c_2$ .

$$\begin{aligned} y(0) &= c_1 = 3 \\ y'(0) &= c_2 = -1. \end{aligned}$$

Hence,  $y = 3 - t + t^3$  is the solution to the given initial value problem.

26. The auxiliary equation,  $r^2 + 9 = 0$ , has roots  $r = \pm 3i$ . Therefore, a general solution to the corresponding homogeneous equation is  $y_h(t) = c_1 \cos 3t + c_2 \sin 3t$ , and a particular solution to the original equation has the form  $y_p(t) = A_0$ . Substituting this function into the given equation, we find the constant  $A_0$ .

$$y_p'' + 9y_p = 9A_0 = 27 \quad \Rightarrow \quad A_0 = 3,$$

and a general solution to the given nonhomogeneous equation is

$$y(t) = 3 + c_1 \cos 3t + c_2 \sin 3t.$$

Next, since  $y'(t) = -3c_1 \sin 3t + 3c_2 \cos 3t$ , from the initial conditions we get a system for determining constants  $c_1$  and  $c_2$ .

$$\begin{aligned} 4 = y(0) &= 3 + c_1 & \Rightarrow & & c_1 = 1 & \Rightarrow & & y(t) = 3 + \cos 3t + 2 \sin 3t. \\ 6 = y'(0) &= 3c_2 & \Rightarrow & & c_2 = 2 & & & \end{aligned}$$

28. The roots of the auxiliary equation,  $r^2 + r - 12 = 0$ , are  $r = -4$  and  $r = 3$ . This gives a general solution to the corresponding homogeneous equation of the form  $y_h(t) =$

## Chapter 4

$c_1e^{-4t} + c_2e^{3t}$ . We use the superposition principle to find a particular solution to the given nonhomogeneous equation.

$$\begin{aligned} y_p &= A_0e^t + B_0e^{2t} + C_0 \Rightarrow y'_p = A_0e^t + 2B_0e^{2t} \Rightarrow y''_p = A_0e^t + 4B_0e^{2t}; \\ y''_p + y'_p - 12y_p &= -10A_0e^t - 6B_0e^{2t} - 12C_0 = e^t + e^{2t} - 1. \end{aligned}$$

Therefore,  $A_0 = -1/10$ ,  $B_0 = -1/6$ ,  $C_0 = 1/12$ , and a general solution to the original equation is

$$y(t) = -\frac{e^t}{10} - \frac{e^{2t}}{6} + \frac{1}{12} + c_1e^{-4t} + c_2e^{3t}.$$

Next, we find  $c_1$  and  $c_2$  such that the initial conditions are satisfied. Since

$$y'(t) = -\frac{e^t}{10} - \frac{e^{2t}}{3} - 4c_1e^{-4t} + 3c_2e^{3t},$$

we have

$$\begin{aligned} 1 = y(0) &= -1/10 - 1/6 + 1/12 + c_1 + c_2 & \Rightarrow & c_1 + c_2 = 71/60 \\ 3 = y'(0) &= -1/10 - 1/3 - 4c_1 + 3c_2 & & -4c_1 + 3c_2 = 103/30. \end{aligned}$$

Solving yields  $c_1 = 1/60$ ,  $c_2 = 7/6$ . With these constants, the solution becomes

$$y(t) = -\frac{e^t}{10} - \frac{e^{2t}}{6} + \frac{1}{12} + \frac{e^{-4t}}{60} + \frac{7e^{3t}}{6}.$$

- 30.** The auxiliary equation,  $r^2 + 2r + 1 = 0$  has a double root  $r = -1$ . Therefore, a general solution to the corresponding homogeneous equation is

$$y_h(t) = c_1e^{-t} + c_2te^{-t}.$$

By the superposition principle, a particular solution to the original nonhomogeneous equation has the form

$$y_p = A_2t^2 + A_1t + A_0 + B_0e^t \Rightarrow y'_p = 2A_2t + A_1 + B_0e^t \Rightarrow y''_p = 2A_2 + B_0e^t.$$

Therefore,

$$\begin{aligned} y''_p + 2y'_p + y_p &= A_2t^2 + (A_1 + 4A_2)t + (A_0 + 2A_1 + 2A_2) + 4B_0e^t \\ &= t^2 + 1 - e^t. \end{aligned}$$

Matching coefficients yields

$$A_2 = 1, \quad A_1 = -4A_2 = -4, \quad A_0 = 1 - 2A_1 - 2A_2 = 7, \quad B_0 = -\frac{1}{4},$$

and a general solution is

$$y(t) = y_p(t) + y_h(t) = t^2 - 4t + 7 - \frac{e^t}{4} + c_1 e^{-t} + c_2 t e^{-t}.$$

Next, we satisfy the initial conditions.

$$\begin{aligned} 0 = y(0) &= 7 - 1/4 + c_1 & \Rightarrow & c_1 = -27/4 \\ 2 = y'(0) &= -4 - 1/4 - c_1 + c_2 & & c_2 = 25/4 + c_1 = -1/2. \end{aligned}$$

Therefore, the solution to the given initial value problem is

$$y(t) = t^2 - 4t + 7 - \frac{e^t}{4} - \frac{27e^{-t}}{4} - \frac{te^{-t}}{2}.$$

**32.** For the nonhomogeneous term,

$$e^{2t} + te^{2t} + t^2 e^{2t} = (1 + t + t^2) e^{2t},$$

a particular solution has the form

$$y_p(t) = t^s (A_0 + A_1 t + A_2 t^2) e^{2t}.$$

Since  $r = 2$  is not a root of the auxiliary equation,  $r^2 - 1 = 0$ , we choose  $s = 0$ .

**34.** Neither  $r = i$  nor  $r = 2i$  is a root of the auxiliary equation, which is  $r^2 + 5r + 6 = 0$ . Thus, by the superposition principle,

$$y_p(t) = A \cos t + B \sin t + C \cos 2t + D \sin 2t.$$

**36.** Since the auxiliary equation,  $r^2 - 4r + 4 = (r - 2)^2 = 0$  has a double root  $r = 2$  and the nonhomogeneous term can be written as

$$t^2 e^{2t} - e^{2t} = (t^2 - 1) e^{2t},$$

a particular solution to the given equation has the form

$$y_p(t) = t^2 (A_2 t^2 + A_1 t + A_0) e^{2t}.$$

**38.** Since, by inspection,  $r = i$  is not a root of the auxiliary equation, which is  $r^4 - 5r^2 + 4 = 0$ , we look for a particular solution of the form

$$y_p(t) = A \cos t + B \sin t.$$



## Chapter 4

Differentiating  $y_p(t)$  four times, we get

$$y_p'(t) = -A \sin t + B \cos t,$$

$$y_p''(t) = -A \cos t - B \sin t,$$

$$y_p'''(t) = A \sin t - B \cos t,$$

$$y_p^{(4)}(t) = A \cos t + B \sin t.$$

Therefore,

$$y_p^{(4)} - 5y_p'' + 4y_p = 10A \cos t + 10B \sin t = 10 \cos t - 20 \sin t.$$

So,  $A = 1$ ,  $B = -2$ , and a particular solution to the given equation is

$$y(t) = \cos t - 2 \sin t.$$

40. Since  $r = 0$  is a simple root of the auxiliary equation,  $r^4 - 3r^3 + 3r^2 - r = r(r-1)^3 = 0$ , a particular solution to the given nonhomogeneous equation has the form

$$y_p(t) = t(A_1 t + A_0) = A_1 t^2 + A_0 t.$$

Substituting this function into the given equation, we find that

$$y_p^{(4)} - 3y_p''' + 3y_p'' - y_p' = 3(2A_1) - (2A_1 t + A_0) = 6t - 20.$$

Thus,  $A_1 = -3$ ,  $A_0 = 6A_1 + 20 = 2$ , and a particular solution to the given equation is

$$y(t) = -3t^2 + 2t.$$

42. (a) The auxiliary equation in this problem is

$$mr^2 + br + k = 0 \quad \Rightarrow \quad r^2 + (b/m)r + (k/m) = 0,$$

which has roots

$$r = -\frac{b}{2m} \pm \sqrt{\left(\frac{b}{2m}\right)^2 - \frac{k}{m}} = -\frac{b}{2m} \pm \sqrt{\frac{k}{m} - \left(\frac{b}{2m}\right)^2} i.$$

(Recall that  $b^2 < 4mk$ .) Denoting

$$\omega := \sqrt{\frac{k}{m} - \left(\frac{b}{2m}\right)^2},$$

we obtain a general solution

$$y_h(t) = (c_1 \cos \omega t + c_2 \sin \omega t) e^{-bt/(2m)}$$

to the corresponding homogeneous equation. Since  $b > 0$ ,  $r = \beta i$  is not a root of the auxiliary equation. Therefore, a particular solution to (15) has the form

$$\begin{aligned} y_p(t) &= A \cos \beta t + B \sin \beta t \\ \Rightarrow y_p'(t) &= B\beta \cos \beta t - A\beta \sin \beta t \\ \Rightarrow y_p''(t) &= -A\beta^2 \cos \beta t - B\beta^2 \sin \beta t. \end{aligned}$$

Thus,

$$\begin{aligned} my_p'' + by_p' + ky_p &= (-A\beta^2 m + B\beta b + Ak) \cos \beta t \\ &\quad + (-B\beta^2 m - A\beta b + Bk) \sin \beta t = \sin \beta t. \end{aligned}$$

Matching coefficients yields

$$\begin{aligned} A(k - \beta^2 m) + B\beta b &= 0 \\ B(k - \beta^2 m) - A\beta b &= 1. \end{aligned}$$

Solving, we obtain

$$A = -\frac{\beta b}{(k - \beta^2 m)^2 + (\beta b)^2}, \quad B = \frac{k - \beta^2 m}{(k - \beta^2 m)^2 + (\beta b)^2}.$$

Therefore, a general solution to (15) is

$$\begin{aligned} y(t) &= -\frac{\beta b}{(k - \beta^2 m)^2 + (\beta b)^2} \cos \beta t + \frac{k - \beta^2 m}{(k - \beta^2 m)^2 + (\beta b)^2} \sin \beta t \\ &\quad + (c_1 \cos \omega t + c_2 \sin \omega t) e^{-bt/(2m)}. \end{aligned}$$

- (b) The solution in part (a) consists of two terms. The second term,  $y_h$ , represents damped oscillation, depends on the parameters of the system and initial conditions. Because of the exponential factor,  $e^{-bt/(2m)}$ , this term will die off, as  $t \rightarrow \infty$ . Thus, the first term,  $y_p$  caused by the external force will eventually dominate and essentially govern the motion of the system. With time, the motion will look more and more like a sinusoidal one with angular frequency  $\beta$ .

## Chapter 4

44. Substituting the mass  $m = 1$ , damping coefficient  $b = 2$ , spring constant  $k = 5$ , and external force  $g(t) = 2 \sin 3t + 10 \cos 3t$  into (15) and taking into account the initial conditions, we get an initial value problem

$$y'' + 2y' + 5y = 2 \sin 3t + 10 \cos 3t; \quad y(0) = -1, \quad y'(0) = 5.$$

The roots of the auxiliary equation,  $r^2 + 2r + 5 = 0$ , are  $r = -1 \pm 2i$ , and a general solution to the corresponding homogeneous equation is

$$y_h(t) = (c_1 \cos 2t + c_2 \sin 2t) e^{-t}.$$

We look for a particular solution to the original equation of the form

$$y_p(t) = A_0 \cos 3t + B_0 \sin 3t.$$

Substituting this function into the equation, we get

$$\begin{aligned} y_p'' + 2y_p' + 5y_p &= (-9A_0 \cos 3t - 9B_0 \sin 3t) + 2(-3A_0 \sin 3t + 3B_0 \cos 3t) \\ &\quad + 5(A_0 \cos 3t + B_0 \sin 3t) \\ &= (-4A_0 + 6B_0) \cos 3t + (-6A_0 - 4B_0) \sin 3t = 2 \sin 3t + 10 \cos 3t \\ \Rightarrow \quad \begin{aligned} -4A_0 + 6B_0 &= 10 & \Rightarrow \quad A_0 &= -1 \\ -6A_0 - 4B_0 &= 2 & \Rightarrow \quad B_0 &= 1. \end{aligned} \end{aligned}$$

Thus, a general solution to the equation describing the motion is

$$y(t) = -\cos 3t + \sin 3t + (c_1 \cos 2t + c_2 \sin 2t) e^{-t}.$$

Differentiating, we find

$$y(t) = 3 \sin 3t + 3 \cos 3t + [(-c_1 + 2c_2) \cos 2t + (-c_2 - 2c_1) \sin 2t] e^{-t}.$$

Initial conditions give a system

$$\begin{aligned} y(0) &= -1 + c_1 = -1 & \Rightarrow \quad c_1 &= 0 \\ y'(0) &= 3 - c_1 + 2c_2 = 5 & \Rightarrow \quad c_2 &= 1. \end{aligned}$$

Hence, the equation of motion is

$$y(t) = -\cos 3t + \sin 3t + e^{-t} \sin 2t.$$

**46.** The auxiliary equation in this problem is  $r^2 + \lambda^2 = 0$ , which has the roots  $r = \pm \lambda i$ . Therefore, a general solution to the corresponding homogeneous equation is given by

$$y_h = c_1 \cos \lambda t + c_2 \sin \lambda t.$$

For a particular solution to the nonhomogeneous equation, we distinguish two cases.

(i)  $\lambda \neq \pm 1$ . In this case, a particular solution has the form

$$y_p = A_0 \cos t + B_0 \sin t \quad \Rightarrow \quad y_p'' = -A_0 \cos t - B_0 \sin t,$$

and so

$$y_p'' + \lambda^2 y_p = (\lambda^2 - 1)(A_0 \cos t + B_0 \sin t) = \sin t.$$

Therefore,  $A_0 = 0$ ,  $B_0 = 1/(\lambda^2 - 1)$ , and a general solution to the given equation is

$$y(t) = \frac{1}{\lambda^2 - 1} \sin t + c_1 \cos \lambda t + c_2 \sin \lambda t.$$

The first boundary condition yields

$$y(0) = c_1 = 0 \quad \Rightarrow \quad y = \frac{1}{\lambda^2 - 1} \sin t + c_2 \sin \lambda t.$$

Now, if  $\lambda$  is an integer, then

$$y(\pi) = \frac{1}{\lambda^2 - 1} \sin t + c_2 \sin \lambda t \Big|_{t=\pi} = 0$$

for any constant  $c_2$ . Hence, the second boundary condition cannot be satisfied. If  $\lambda$  is not an integer, then  $\sin \lambda \pi \neq 0$ ,

$$y(\pi) = \frac{1}{\lambda^2 - 1} \sin t + c_2 \sin \lambda t \Big|_{t=\pi} = c_2 \sin \lambda \pi = 1$$

for  $c_2 = 1/\sin \lambda \pi$ , and the boundary value problem has a unique solution

$$y(t) = \frac{1}{\lambda^2 - 1} \sin t + \frac{1}{\sin \lambda \pi} \sin \lambda t.$$

(ii)  $\lambda = \pm 1$ . Here, a particular solution has the form

$$y_p = t(A_0 \cos t + B_0 \sin t) \quad \Rightarrow \quad y_p'' = A_0(-2 \sin t - t \cos t) + B_0(2 \cos t - t \sin t),$$

Substituting  $y_p$  into the original equation (with  $\lambda = \pm 1$ ), we get

$$y_p'' + y_p = 2B_0 \cos t - 2A_0 \sin t = \sin t \quad \Rightarrow \quad A_0 = -\frac{1}{2}, \quad B_0 = 0,$$

## Chapter 4

and a general solution is given by

$$y(t) = -\frac{t \cos t}{2} + c_1 \cos t + c_2 \sin t.$$

The first boundary condition,  $y(0) = 0$ , yields  $c_1 = 0$ . But this implies that

$$y(\pi) = -\frac{t \cos t}{2} + c_2 \sin t \Big|_{t=\pi} = \frac{\pi}{2} \neq 1,$$

for any constant  $c_2$ .

**48. (a)** Using the superposition principle (Theorem 3), we conclude that the functions

$$\begin{aligned} y_1(t) &= (t^2 + 1 + e^t \cos t + e^t \sin t) - (t^2 + 1 + e^t \cos t) = e^t \sin t, \\ y_2(t) &= (t^2 + 1 + e^t \cos t + e^t \sin t) - (t^2 + 1 + e^t \sin t) = e^t \cos t \end{aligned}$$

are solutions to the corresponding homogeneous equation. These two functions are linearly independent on  $(-\infty, \infty)$  since neither one is a constant multiple of the other.

**(b)** Substituting, say,  $y_1(t)$  into the corresponding homogeneous equation yields

$$(e^t \sin t)'' + p(e^t \sin t)' + q(e^t \sin t) = (2 + p)e^t \cos t + (p + q)e^t \sin t = 0.$$

Therefore,  $p = -2$ ,  $q = -p = 2$ , and so the equation becomes

$$y'' - 2y' + 2y = g(t). \tag{4.3}$$

Another way to recover  $p$  and  $q$  is to use the results of Section 4.3. The functions  $y_1(t)$  and  $y_2(t)$  fit the form of two linearly independent solutions in the case when the auxiliary equation has complex roots  $\alpha \pm \beta i$ . Here,  $\alpha = \beta = 1$ . Thus, the auxiliary equation must be

$$[r - (1 + i)] \cdot [r - (1 - i)] = (r - 1)^2 + 1 = r^2 - 2r + 2,$$

leading to the same conclusion about  $p$  and  $q$ .

To find  $g(t)$ , one can just substitute either of three given functions into (4.3). But we can simplify computations noting that, say,

$$y = t^2 + 1 + e^t \cos t - y_2(t) = t^2 + 1$$

is a solution to the given equation (by the superposition principle). Thus, we have

$$g(t) = (t^2 + 1)'' - 2(t^2 + 1)' + 2(t^2 + 1) = 2t^2 - 4t + 4.$$

**EXERCISES 4.6: Variation of Parameters**

2. From Example 1 in the text, we know that functions  $y_1(t) = \cos t$  and  $y_2(t) = \sin t$  are two linearly independent solutions to the corresponding homogeneous equation, and so its general solution is given by

$$y_h(t) = c_1 \cos t + c_2 \sin t.$$

Now we apply the method of variation of parameters to find a particular solution to the original equation. By the formula (3) in the text,  $y_p(t)$  has the form

$$y_p(t) = v_1(t)y_1(t) + v_2(t)y_2(t).$$

Since

$$y_1'(t) = (\cos t)' = -\sin t, \quad y_2'(t) = (\sin t)' = \cos t,$$

the system (9) becomes

$$\begin{aligned} v_1'(t) \cos t + v_2'(t) \sin t &= 0 \\ -v_1'(t) \sin t + v_2'(t) \cos t &= \sec t. \end{aligned}$$

Multiplying the first equation by  $\sin t$  and the second equation by  $\cos t$  yields

$$\begin{aligned} v_1'(t) \sin t \cos t + v_2'(t) \sin^2 t &= 0 \\ -v_1'(t) \sin t \cos t + v_2'(t) \cos^2 t &= 1. \end{aligned}$$

Adding these equations together, we obtain

$$v_2'(t) (\cos^2 t + \sin^2 t) = 1 \quad \text{or} \quad v_2'(t) = 1.$$

From the first equation in the system, we can now find  $v_1'(t)$ .

$$v_1'(t) = -v_2'(t) \frac{\sin t}{\cos t} = -\tan t.$$

So,

$$\begin{aligned} v_1'(t) = -\tan t & & \Rightarrow & & v_1(t) = -\int \tan t \, dt = \ln |\cos t| + c_3 \\ v_2'(t) = 1 & & & & v_2(t) = \int dt = t + c_4. \end{aligned}$$

Since we are looking for a particular solution, we can take  $c_3 = c_4 = 0$  and get

$$y_p(t) = (\cos t) \ln |\cos t| + t \sin t.$$

Thus, a general solution to the given equation is

$$y(t) = y_p(t) + y_h(t) = (\cos t) \ln |\cos t| + t \sin t + c_1 \cos t + c_2 \sin t.$$

## Chapter 4

4. This equation has associated homogeneous equation  $y'' - y = 0$ . The roots of the associated auxiliary equation,  $r^2 - 1 = 0$ , are  $r = \pm 1$ . Therefore, a general solution to this equation is

$$y_h(t) = c_1 e^t + c_2 e^{-t}.$$

For the variation of parameters method, we let

$$y_p(t) = v_1(t)y_1(t) + v_2(t)y_2(t), \quad \text{where} \quad y_1(t) = e^t \quad \text{and} \quad y_2(t) = e^{-t}.$$

Thus,  $y_1'(t) = e^t$  and  $y_2'(t) = -e^{-t}$ . This means that we have to solve the system

$$\begin{aligned} e^t v_1' + e^{-t} v_2' &= 0 \\ e^t v_1' - e^{-t} v_2' &= 2t + 4. \end{aligned}$$

Adding these two equations yields

$$2e^t v_1' = 2t + 4 \quad \Rightarrow \quad v_1' = (t + 2)e^{-t}.$$

Integration yields

$$v_1(t) = \int (t + 2)e^{-t} dt = -(t + 3)e^{-t}.$$

Substituting  $v_1'$  into the first equation, we get

$$v_2' = -v_1' e^{2t} = -(t + 2)e^t \quad \Rightarrow \quad v_2(t) = -\int (t + 2)e^t dt = -(t + 1)e^t.$$

Therefore,

$$y_p(t) = -(t + 3)e^{-t}e^t - (t + 1)e^t e^{-t} = -(2t + 4),$$

and a general solution is

$$y(t) = -(2t + 4) + c_1 e^t + c_2 e^{-t}.$$

6. This equation has associated homogeneous equation  $y'' + 2y' + y = 0$ . Its auxiliary equation,  $r^2 + 2r + 1 = 0$ , has a double root  $r = -1$ . Thus, a general solution to the homogeneous equation is  $y_h(t) = c_1 e^{-t} + c_2 t e^{-t}$ . For the variation of parameters method, we let

$$y_p(t) = v_1(t)y_1(t) + v_2(t)y_2(t), \quad \text{where} \quad y_1(t) = e^{-t} \quad \text{and} \quad y_2(t) = t e^{-t}.$$

Thus,  $y_1'(t) = -e^{-t}$  and  $y_2'(t) = (1-t)e^{-t}$ . This means that we have to solve the system (see system (9) in text)

$$\begin{aligned} e^{-t}v_1' + te^{-t}v_2' &= 0 \\ -e^{-t}v_1' + (1-t)e^{-t}v_2' &= e^{-t}. \end{aligned}$$

Adding these two equations yields

$$e^{-t}v_2' = e^{-t} \quad \Rightarrow \quad v_2' = 1 \quad \Rightarrow \quad v_2 = \int (1)dt = t.$$

Also, from the first equation of the system we have

$$v_1' = -tv_2' = -t \quad \Rightarrow \quad v_1 = -\int t dt = -\frac{t^2}{2}.$$

Therefore,

$$\begin{aligned} y_p(t) &= -\frac{t^2}{2}e^{-t} + t \cdot te^{-t} = \frac{t^2}{2}e^{-t} \\ \Rightarrow \quad y(t) &= y_p(t) + y_h(t) = \frac{t^2}{2}e^{-t} + c_1e^{-t} + c_2te^{-t}. \end{aligned}$$

8. In this problem, the corresponding homogeneous equation is  $r^2 + 9 = 0$  with roots  $r = \pm 3i$ . Hence,  $y_1(t) = \cos 3t$  and  $y_2(t) = \sin 3t$  are two linearly independent solutions, and a general solution to the corresponding homogeneous equation is given by

$$y_h(t) = c_1 \cos 3t + c_2 \sin 3t,$$

and, in the method of variation of parameters, a particular solution has the form

$$y_p(t) = v_1(t) \cos 3t + v_2(t) \sin 3t,$$

where  $v_1'(t)$ ,  $v_2'(t)$  satisfy the system

$$\begin{aligned} v_1'(t) \cos 3t + v_2'(t) \sin 3t &= 0 \\ -3v_1'(t) \sin 3t + 3v_2'(t) \cos 3t &= \sec^2 3t. \end{aligned}$$

Multiplying the first equation by  $3 \sin 3t$  and the second equation by  $\cos 3t$ , and adding the resulting equations, we get

$$3v_2' (\sin^2 3t + \cos^2 3t) = \sec 3t \quad \Rightarrow \quad v_2' = \frac{1}{3} \sec 3t$$



## Chapter 4

$$\Rightarrow v_2 = \frac{1}{3} \int \sec 3t \, dt = \frac{1}{9} \ln |\sec 3t + \tan 3t|.$$

From the first equation in the system we also find that

$$\begin{aligned} v_1'(t) &= -v_2'(t) \tan 3t = -\frac{1}{3} \sec 3t \tan 3t \\ \Rightarrow v_1(t) &= -\frac{1}{3} \int \sec 3t \tan 3t \, dt = -\frac{1}{9} \sec 3t. \end{aligned}$$

Therefore,

$$\begin{aligned} y_p(t) &= -\frac{1}{9} \sec 3t \cos 3t + \frac{1}{9} \sin 3t \ln |\sec 3t + \tan 3t| \\ &= -\frac{1}{9} + \frac{1}{9} \sin 3t \ln |\sec 3t + \tan 3t| \end{aligned}$$

and

$$y(t) = -\frac{1}{9} + \frac{1}{9} \sin 3t \ln |\sec 3t + \tan 3t| + c_1 \cos 3t + c_2 \sin 3t$$

is a general solution to the given equation.

- 10.** This equation has associated homogeneous equation  $y'' + 4y' + 4y = 0$ . Its auxiliary equation,  $r^2 + 4r + 4 = 0$ , has a double root  $r = -2$ . Thus, a general solution to the homogeneous equation is

$$y_h(t) = c_1 e^{-2t} + c_2 t e^{-2t}.$$

We look for a particular solution to the given equation in the form

$$y_p(t) = v_1(t)y_1(t) + v_2(t)y_2(t), \quad \text{where} \quad y_1(t) = e^{-2t} \quad \text{and} \quad y_2(t) = t e^{-2t}.$$

Since  $y_1' = -2e^{-2t}$  and  $y_2' = (1 - 2t)e^{-2t}$ ,  $v_1'$  and  $v_2'$  satisfy the system

$$\begin{aligned} e^{-2t}v_1' + t e^{-2t}v_2' &= 0 \\ -2e^{-2t}v_1' + (1 - 2t)e^{-2t}v_2' &= e^{-2t} \ln t. \end{aligned}$$

Multiplying the first equation by 2 and then adding them together yields

$$e^{-2t}v_2' = e^{-2t} \ln t \quad \Rightarrow \quad v_2' = \ln t \quad \Rightarrow \quad v_2 = \int \ln t \, dt = t(\ln t - 1).$$

Since  $v_1' = -tv_2' = -t \ln t$ , we find that

$$v_1 = - \int t \ln t \, dt = - \left( \frac{1}{2} t^2 \ln t - \frac{1}{4} t^2 \right).$$

So,

$$y_p(t) = -\left(\frac{1}{2}t^2 \ln t - \frac{1}{4}t^2\right)e^{-2t} + t(\ln t - 1) \cdot te^{-2t} = \frac{2 \ln t - 3}{4}t^2e^{-2t},$$

and a general solution is given by

$$y(t) = \frac{2 \ln t - 3}{4}t^2e^{-2t} + c_1e^{-2t} + c_2te^{-2t}.$$

- 12.** The corresponding homogeneous equation is  $y'' + y = 0$ . Its auxiliary equation has the roots  $r = \pm i$ . Hence, a general solution to the homogeneous corresponding problem is given by

$$y_h = c_1 \cos t + c_2 \sin t.$$

We will find a particular solution to the original equation by representing the right-hand side as a sum

$$\tan t + e^{3t} - 1 = g_1(t) + g_2(t),$$

where  $g_1(t) = \tan t$  and  $g_2(t) = e^{3t} - 1$ .

A particular solution to

$$y'' + y = g_1(t)$$

was found in Example 1, namely,

$$y_{p,1} = -(\cos t) \ln |\sec t + \tan t|.$$

A particular solution to

$$y'' + y = g_2(t)$$

can be found using the method of undetermined coefficients. We let

$$y_{p,2} = A_0e^{3t} + B_0 \quad \Rightarrow \quad y''_{p,2} = 9A_0e^{3t}.$$

Substituting these functions yields

$$y''_{p,2} + y_{p,2} = (9A_0e^{3t}) + (A_0e^{3t} + B_0) = 10A_0e^{3t} + B_0 = e^{3t} - 1.$$

Hence,  $A_0 = 1/10$ ,  $B_0 = -1$ , and  $y_{p,2} = (1/10)e^{3t} - 1$ .

By the superposition principle,

$$y = y_{p,1} + y_{p,2} + y_h = -(\cos t) \ln |\sec t + \tan t| + (1/10)e^{3t} - 1 + c_1 \cos t + c_2 \sin t$$

gives a general solution to the original equation.

## Chapter 4

- 14.** A fundamental solution set for the corresponding homogeneous equation is  $y_1(\theta) = \cos \theta$  and  $y_2(\theta) = \sin \theta$  (see Example 1 in the text or Problem 12). Applying the method of variation of parameters, we seek a particular solution to the given equation in the form  $y_p = v_1 y_1 + v_2 y_2$ , where  $v_1$  and  $v_2$  satisfy

$$\begin{aligned}v_1'(\theta) \cos \theta + v_2'(\theta) \sin \theta &= 0 \\-v_1'(\theta) \sin \theta + v_2'(\theta) \cos \theta &= \sec^3 \theta.\end{aligned}$$

Multiplying the first equation by  $\sin \theta$  and the second equation by  $\cos \theta$ , and adding them together yields

$$v_2'(\theta) = \sec^2 \theta \quad \Rightarrow \quad v_1'(\theta) = -v_2'(\theta) \tan \theta = -\tan \theta \sec^2 \theta.$$

Integrating, we get

$$\begin{aligned}v_1(\theta) &= -\int \tan \theta \sec^2 \theta \, d\theta = -\frac{1}{2} \tan^2 \theta, \\v_2(\theta) &= \int \sec^2 \theta \, d\theta = \tan \theta,\end{aligned}$$

where we have taken zero integration constants. Therefore,

$$y_p(\theta) = -\frac{1}{2} \tan^2 \theta \cos t + \tan \theta \sin t = \frac{1}{2} \tan \theta \sin \theta,$$

and a general solution is given by

$$y(\theta) = y_p(\theta) + y_h(\theta) = \frac{\tan \theta \sin \theta}{2} + c_1 \cos \theta + c_2 \sin \theta.$$

- 16.** The corresponding homogeneous equation is  $y'' + 5y' + 6y = 0$ . Its auxiliary equation has the roots  $r = -2, -3$ . Hence, a general solution to the homogeneous problem is given by

$$y_h = c_1 e^{-2t} + c_2 e^{-3t}.$$

In this problem, we can apply the method of undetermined coefficients to find a particular solution to the given nonhomogeneous equation.

$$y_p = A_2 t^2 + A_1 t + A_0 \quad \Rightarrow \quad y_p' = 2A_2 t + A_1 \quad \Rightarrow \quad y_p'' = 2A_2.$$

Substituting these functions into the original equation yields

$$6A_2 t^2 + (10A_2 + 6A_1)t + (2A_2 + 5A_1 + 6A_0) = 18t^2.$$

Therefore,

$$\begin{aligned} A_2 &= 3, & A_1 &= -10A_2/6 = -5, & A_0 &= -(2A_2 + 5A_1)/6 = 19/6 \\ \Rightarrow & & y_p &= 3t^2 - 5t + \frac{19}{6}, \end{aligned}$$

and

$$y = y_p + y_h = 3t^2 - 5t + \frac{19}{6} + c_1e^{-2t} + c_2e^{-3t}$$

is a general solution.

- 18.** The auxiliary equation in this problem,  $r^2 - 6r + 9 = (r - 3)^2 = 0$ , has a double root  $r = 3$ . Therefore, a fundamental solution set for corresponding homogeneous equation is  $y_1(t) = e^{3t}$  and  $y_2(t) = te^{3t}$ . We now set

$$y_p(t) = v_1(t)y_1(t) + v_2(t)y_2(t),$$

where  $v_1$  and  $v_2$  satisfy

$$\begin{aligned} e^{3t}v_1' + te^{3t}v_2' &= 0, \\ 3e^{3t}v_1' + (1 + 3t)e^{3t}v_2' &= t^{-3}e^{3t}. \end{aligned}$$

Subtracting the first equation multiplied by 3 from the second one, we get

$$e^{3t}v_2' = t^{-3}e^{3t} \quad \Rightarrow \quad v_2' = t^{-3} \quad \Rightarrow \quad v_2(t) = -\frac{1}{2t^2}.$$

Substituting  $v_2'$  into the first equation yields

$$v_1' = -tv_2' = -t^{-2} \quad \Rightarrow \quad v_1(t) = \frac{1}{t}.$$

Thus,

$$\begin{aligned} y_p(t) &= \frac{1}{t}e^{3t} - \frac{1}{2t^2}te^{3t} = \frac{e^{3t}}{2t}, \\ y(t) &= y_p(t) + c_1y_1(t) + c_2y_2(t) = \frac{e^{3t}}{2t} + c_1e^{3t} + c_2te^{3t}. \end{aligned}$$

- 20.** Since  $y_h(t) = c_1 \cos t + c_2 \sin t$  is a general solution to the corresponding homogeneous equation, we have to verify that the integral part of  $y(t)$  is a particular solution to the original nonhomogeneous problem. Applying the method of variation of parameters, we form the system (9).

$$\begin{aligned} v_1' \cos t + v_2' \sin t &= 0 \\ -v_1' \sin t + v_2' \cos t &= f(t). \end{aligned}$$

## Chapter 4

Multiplying the first equation by  $\sin t$ , the second equation by  $\cos t$ , and adding them yields

$$v_2' = f(t) \cos t \quad \Rightarrow \quad v_1' = -v_2' \sin t / \cos t = -f(t) \sin t.$$

Integrating, we obtain

$$v_1(t) = - \int_0^t f(s) \sin s \, ds, \quad v_2(t) = \int_0^t f(s) \cos s \, ds.$$

Hence, a particular solution to the given equation is

$$\begin{aligned} y_p(t) &= y_2(t)v_2(t) + y_1(t)v_1(t) \\ &= \sin t \int_0^t f(s) \cos s \, ds - \cos t \int_0^t f(s) \sin s \, ds \\ &= \int_0^t f(s) \sin t \cos s \, ds - \int_0^t f(s) \cos t \sin s \, ds \\ &= \int_0^t f(s) (\sin t \cos s - \cos t \sin s) \, ds = \int_0^t f(s) \sin(t-s) \, ds. \end{aligned}$$

### EXERCISES 4.7: Variable-Coefficient Equations

2. Writing the equation in standard form,

$$y'' + \frac{2}{t-3} y' - \frac{1}{t(t-3)} y = \frac{t}{t-3},$$

we see that the coefficients  $p(t) = 2/(t-3)$  and  $q(t) = 1/[t(t-3)]$ , and  $g(t) = t/(t-3)$  are simultaneously continuous on  $(-\infty, 0)$ ,  $(0, 3)$ , and  $(3, \infty)$ . Since the initial value of  $t$  belongs to  $(0, 3)$ , Theorem 5 applies, and so there exists a unique solution to the given initial value problem on  $(0, 3)$  (with any choice of  $Y_0$  and  $Y_1$ ).

4. The standard form for this equation is

$$y'' + \frac{1}{t^2} y = \frac{\cos t}{t^2}.$$

The function  $p(t) \equiv 0$  is continuous everywhere,  $q(t) = t^{-2}$ , and  $g(t) = t^{-2} \cos t$  are simultaneously continuous on  $(-\infty, 0)$  and  $(0, \infty)$ . Thus, the given initial value problem has a unique solution on  $(0, \infty)$ .

6. Theorem 5 does not apply to this initial value problem since the initial point,  $t = 0$ , is a point of discontinuity of (say)  $p(t) = t^{-1}$  (actually,  $q(t)$  and  $g(t)$  are also discontinuous at this point).
8. Theorem 5 does not apply because the given problem is not an initial value problem.
10. In this a homogeneous Cauchy-Euler equation with

$$a = 1, \quad b = 2, \quad c = -6.$$

Thus, substituting  $y = t^r$ , we get its characteristic equation (see (7))

$$ar^2 + (b - a)r + c = r^2 + r - 6 = 0 \quad \Rightarrow \quad r = -3, 2.$$

Therefore,  $y_1(t) = t^{-3}$  and  $y_2(t) = t^2$  are two linearly independent solutions to the given differential equation, and a general solution has the form

$$y(t) = c_1 t^{-3} + c_2 t^2.$$

12. Comparing this equation with (6), we see that  $a = 1$ ,  $b = 5$ , and  $c = 4$ . Therefore, the corresponding auxiliary equation,

$$ar^2 + (b - a)r + c = r^2 + 4r + 4 = (r + 2)^2 = 0$$

has a double root  $r = -2$ . Therefore,  $y_1(t) = t^{-2}$  and  $y_2(t) = t^{-2} \ln t$  represent two linearly independent solutions, and so

$$y(t) = c_1 t^{-2} + c_2 t^{-2} \ln t$$

is a general solution to the given equation.

14. In this homogeneous Cauchy-Euler equation  $a = 1$ ,  $b = -3$ , and  $c = 4$ . Therefore, the corresponding auxiliary equation,

$$ar^2 + (b - a)r + c = r^2 - 4r + 4 = (r - 2)^2 = 0$$

has a double root  $r = 2$ . Therefore,  $y_1(t) = t^2$  and  $y_2(t) = t^2 \ln t$  are two linearly independent solutions. Hence, a general solution is

$$y(t) = c_1 t^2 + c_2 t^2 \ln t.$$

## Chapter 4

- 16.** In this homogeneous Cauchy-Euler equation  $a = 1$ ,  $b = -3$ , and  $c = 6$ . Therefore, the corresponding auxiliary equation,

$$ar^2 + (b - a)r + c = r^2 - 4r + 6 = (r - 2)^2 + 2 = 0$$

has complex roots  $r = 2 \pm \sqrt{2}i$  with  $\alpha = 2$ ,  $\beta = \sqrt{2}$ . According to (8) in the text, the functions

$$y_1(t) = t^2 \cos(\sqrt{2} \ln t), \quad y_2(t) = t^2 \sin(\sqrt{2} \ln t)$$

are two linearly independent solutions to the given homogeneous equation. Thus, a general solution is given by

$$y = c_1 y_1 + c_2 y_2 = t^2 \left[ c_1 \cos(\sqrt{2} \ln t) + c_2 \sin(\sqrt{2} \ln t) \right].$$

- 18.** The substitution  $y = t^r$  leads the characteristic equation (see (7))

$$r(r - 1) + 3r + 5 = 0 \quad \Rightarrow \quad r^2 + 2r + 5 = (r + 1)^2 + 4 = 0.$$

Solving yields

$$r = -1 \pm 2i.$$

Thus, the roots are complex numbers  $\alpha \pm \beta i$  with  $\alpha = -1$ ,  $\beta = 2$ . According to (8) in the text, the functions

$$y_1(t) = t^{-1} \cos(2 \ln t), \quad y_2(t) = t^{-1} \sin(2 \ln t)$$

are two linearly independent solutions to the given homogeneous equation. Thus, a general solution is given by

$$y = c_1 y_1 + c_2 y_2 = t^{-1} [c_1 \cos(2 \ln t) + c_2 \sin(2 \ln t)].$$

- 20.** First, we find a general solution to the given Cauchy-Euler equation. Substitution  $y = t^r$  leads to the characteristic equation

$$r(r - 1) + 7r + 5 = r^2 + 6r + 5 = 0 \quad \Rightarrow \quad r = -1, -5.$$

Thus,  $y = c_1 t^{-1} + c_2 t^{-5}$  is a general solution. We now find constants  $c_1$  and  $c_2$  such that the initial conditions are satisfied.

$$\begin{aligned} -1 &= y(1) = c_1 + c_2, & \Rightarrow & & c_1 &= 2, \\ 13 &= y'(1) = -c_1 - 5c_2 & & & c_2 &= -3 \end{aligned}$$

and, therefore,  $y = 2t^{-1} - 3t^{-5}$  is the solution to the given initial value problem.

**22.** We will look for solutions to the given equation of the form

$$y(t) = (t+1)^r \quad \Rightarrow \quad y'(t) = r(t+1)^{r-1} \quad \Rightarrow \quad y''(t) = r(r-1)(t+1)^{r-2}.$$

Substituting these formulas into the differential equation yields

$$[r(r-1) + 10r + 14](t+1)^r = 0 \quad \Rightarrow \quad r^2 + 9r + 14 = 0 \quad \Rightarrow \quad r = -2, -7.$$

Therefore,  $y_1 = (t+1)^{-2}$  and  $y_2 = (t+1)^{-7}$  are two linearly independent solutions on  $(-1, \infty)$ . Taking their linear combination, we obtain a general solution of the form

$$y = c_1(t+1)^{-2} + c_2(t+1)^{-7}.$$

**24.** According to Problem 23, the substitution  $t = e^x$  transforms a Cauchy-Euler equation (6) into the constant-coefficient equation (20) in  $Y(x) = y(e^x)$ . In (a)–(d) below, we write (20) for the given equation, apply methods of solving linear equations with constant coefficients developed in Sections 4.2–4.6 to find  $Y(x)$ , and then make the back substitution  $e^x = t$  or  $x = \ln t$ ,  $t > 0$ .

(a)  $Y'' - 9Y = 0$  has an auxiliary equation  $r^2 - 9 = 0$  with two distinct real roots  $r = \pm 3$ . Thus, a general solution is

$$Y(x) = c_1 e^{-3x} + c_2 e^{3x} = c_1 (e^x)^{-3} + c_2 (e^x)^3.$$

Therefore,

$$y(t) = c_1 t^{-3} + c_2 t^3.$$

(b)  $y'' + 2Y' + 10Y = 0$ . The auxiliary equation  $r^2 + 2r + 10 = 0$  has complex roots  $r = -1 \pm 3i$ . Hence,

$$\begin{aligned} Y(x) &= e^{-x} (c_1 \cos 3x + c_2 \sin 3x) = (e^x)^{-1} (c_1 \cos 3x + c_2 \sin 3x) \\ \Rightarrow \quad y(t) &= t^{-1} [c_1 \cos(3 \ln t) + c_2 \sin(3 \ln t)]. \end{aligned}$$

(c)  $Y'' + 2Y' + Y = e^x + (e^x)^{-1} = e^x + e^{-x}$ . This is a nonhomogeneous equation. First, we find a general solution  $Y_h$  to the corresponding homogeneous equation.

$$r^2 + 2r + 1 = (r+1)^2 = 0 \quad \Rightarrow \quad r = -1$$



## Chapter 4

is a double root of the auxiliary equation. Therefore,

$$Y_h(x) = c_1 e^{-x} + c_2 x e^{-x}.$$

By the superposition principle, a particular solution to the nonhomogeneous equation has the form

$$\begin{aligned} Y_p(x) &= Ae^x + Bx^2 e^{-x} \\ Y_p'(x) &= Ae^x + B(2x - x^2) e^{-x} \\ Y_p''(x) &= Ae^x + B(x^2 - 4x + 2) e^{-x}. \end{aligned}$$

Substitution yields

$$\begin{aligned} & [Ae^x + B(x^2 - 4x + 2) e^{-x}] + 2[Ae^x + B(2x - x^2) e^{-x}] \\ & \qquad \qquad \qquad + [Ae^x + Bx^2 e^{-x}] = e^x + e^{-x} \\ \Rightarrow \quad & 4Ae^x + 2Be^{-x} = e^x + e^{-x} \quad \Rightarrow \quad A = \frac{1}{4}, \quad B = \frac{1}{2} \\ \Rightarrow \quad & Y_p(x) = \frac{1}{4} e^x + \frac{1}{2} x^2 e^{-x}. \end{aligned}$$

Thus,

$$Y(x) = Y_p(x) + Y_h(x) = \frac{1}{4} e^x + \frac{1}{2} x^2 e^{-x} + c_1 e^{-x} + c_2 x e^{-x}.$$

The back substitution yields

$$y(t) = \frac{1}{4} t + \frac{1}{2} t^{-1} \ln^2 t + c_1 t^{-1} + c_2 t^{-1} \ln t.$$

- (d)  $Y'' + 9Y = -\tan 3x$ . The auxiliary equation has roots  $r = \pm 3i$ . Therefore, the functions  $Y_1(x) = \cos 3x$  and  $Y_2(x) = \sin 3x$  form a fundamental solution set, and

$$Y_h(x) = c_1 \cos 3x + c_2 \sin 3x$$

is a general solution to the corresponding homogeneous equation. To find a particular solution to the nonhomogeneous equation, we use the variation of parameters method. We look for  $Y_p(x)$  of the form

$$Y_p(x) = v_1(x)Y_1(x) + v_2(x)Y_2(x),$$

where  $v_1$  and  $v_2$  satisfy equations (12) of the text. We find

$$W[Y_1, Y_2](x) = Y_1 Y_2' - Y_1' Y_2 = (\cos 3x)(3 \cos 3x) - (-3 \sin 3x)(\sin 3x) = 3$$

and apply formulas (12).

$$v_1(x) = \int \frac{\tan 3x \sin 3x}{3} dx = -\frac{1}{9} \sin 3x + \frac{1}{9} \ln |\sec 3x + \tan 3x|,$$

$$v_2(x) = - \int \frac{\tan 3x \cos 3x}{3} dx = \frac{1}{9} \cos 3x.$$

Hence,

$$Y_p = \left[ -\frac{1}{9} \sin 3x + \frac{1}{9} \ln |\sec 3x + \tan 3x| \right] \cos 3x + \left[ \frac{1}{9} \cos 3x \right] \sin 3x$$

$$= \frac{1}{9} \cos 3x \ln |\sec 3x + \tan 3x|$$

and so

$$Y(x) = \frac{1}{9} \cos 3x \ln |\sec 3x + \tan 3x| + c_1 \cos 3x + c_2 \sin 3x$$

is a general solution. After back substitution we obtain a general solution

$$y(t) = \frac{1}{9} \cos(3 \ln t) \ln |\sec(3 \ln t) + \tan(3 \ln t)| + c_1 \cos(3 \ln t) + c_2 \sin(3 \ln t)$$

to the original equation.

- 26.** (a) On  $[0, \infty)$ ,  $y_2(t) = t^3 = y_1(t)$ . Thus, they are linearly dependent.  
 (b) On  $(-\infty, 0]$ ,  $y_2(t) = -t^3 = -y_1(t)$ . So, they are linearly dependent.  
 (c) If  $c_1 y_1 + c_2 y_2 \equiv 0$  on  $(-\infty, \infty)$  for some constants  $c_1$  and  $c_2$ , then, evaluating this linear combination at  $t = \pm 1$ , we obtain a system

$$\begin{cases} c_1 + c_2 = 0 \\ -c_1 + c_2 = 0 \end{cases} \Rightarrow c_1 = c_2 = 0.$$

Therefore, these two functions are linearly independent on  $(-\infty, \infty)$ .

- (d) To compute the Wronskian, we need derivatives of  $y_1$  and  $y_2$ .

$$y_1'(t) = 3t^2, \quad -\infty < t < \infty;$$

$$y_2'(t) = \begin{cases} (t^3)' = 3t^2, & t > 0 \\ (-t^3)' = -3t^2, & t < 0 \end{cases} = 3t|t|.$$

Since

$$\lim_{t \rightarrow 0^+} y_2'(t) = \lim_{t \rightarrow 0^-} y_2'(t) = 0,$$

we conclude that  $y_2'(0) = 0$  so that  $y_2'(t) = 3t|t|$  for all  $t$ . Thus,

$$W[y_1, y_2](t) = (t^3)(3t|t|) - (3t^2)|t^3| \equiv 0.$$

## Chapter 4

- 28.** (a) Dependent on  $[0, \infty)$  because  $y_2(t) = 2t^2 = 2y_1(t)$ .  
 (b) Dependent on  $(-\infty, 0]$  because  $y_2(t) = -2t^2 = -2y_1(t)$ .  
 (c) If  $c_1y_1 + c_2y_2 \equiv 0$  on  $(-\infty, \infty)$  for some constants  $c_1$  and  $c_2$ , then, evaluating this linear combination at  $t = \pm 1$ , we obtain a system

$$\begin{cases} c_1 + 2c_2 = 0 \\ c_1 - 2c_2 = 0 \end{cases} \Rightarrow c_1 = c_2 = 0.$$

Therefore, these two functions are linearly independent on  $(-\infty, \infty)$ .

- (d) To compute the Wronskian, we need derivatives of  $y_1$  and  $y_2$ .

$$\begin{aligned} y_1'(t) &= 2t, & -\infty < t < \infty; \\ y_2'(t) &= \begin{cases} (2t^2)' = 4t, & t > 0 \\ (-2t^2)' = -4t, & t < 0 \end{cases} = 4|t|. \end{aligned}$$

Since

$$\lim_{t \rightarrow 0^+} y_2'(t) = \lim_{t \rightarrow 0^-} y_2'(t) = 0,$$

we conclude that  $y_2'(0) = 0$  so that  $y_2'(t) = 4|t|$  for all  $t$ . Thus,

$$W[y_1, y_2](t) = (t^2)(4|t|) - (2t)2t|t| \equiv 0.$$

- 30.** We have

$$\begin{aligned} (c_1y_1 + c_2y_2)' &= c_1y_1' + c_2y_2', \\ (c_1y_1 + c_2y_2)'' &= c_1y_1'' + c_2y_2''. \end{aligned}$$

Thus,

$$\begin{aligned} (c_1y_1 + c_2y_2)'' + p(c_1y_1 + c_2y_2)' + q(c_1y_1 + c_2y_2) & \\ = (c_1y_1'' + pc_1y_1' + qc_1y_1) + (c_2y_2'' + pc_2y_2' + qc_2y_2) & \\ = c_1(y_1'' + py_1' + qy_1) + c_2(y_2'' + py_2' + qy_2) = c_1g_1 + c_2g_2. & \end{aligned}$$

- 32.** (a) Differentiating (18), Section 4.2, yields

$$W' = (y_1y_2' - y_1'y_2)' = (y_1'y_2' + y_1y_2'') - (y_1''y_2 + y_1'y_2') = y_1y_2'' - y_1''y_2.$$

Therefore,

$$\begin{aligned} W' + pW &= (y_1y_2'' - y_1''y_2) + p(y_1y_2' - y_1'y_2) \\ &= y_1(y_2'' + py_2') - y_2(y_1'' + py_1') = y_1(-qy_2) - y_2(-qy_1) = 0. \end{aligned}$$

(b) Separating variables and integrating from  $t_0$  to  $t$  yields

$$\begin{aligned} \frac{dW}{W} = -p dt &\quad \Rightarrow \quad \int_{t_0}^t \frac{dW}{W} = - \int_{t_0}^t p(\tau) d\tau & (4.4) \\ \Rightarrow \quad \ln \left| \frac{W(t)}{W(t_0)} \right| &= - \int_{t_0}^t p(\tau) d\tau \\ \Rightarrow \quad |W(t)| &= |W(t_0)| \exp \left\{ - \int_{t_0}^t p(\tau) d\tau \right\}. \end{aligned}$$

Since the integral on the right-hand side is continuous (even differentiable) on  $(a, b)$ , the exponential function does not vanish on  $(a, b)$ . Therefore,  $W(t)$  has a constant sign on  $(a, b)$  (by the intermediate value theorem), and so we can drop the absolute value signs and obtain

$$W(t) = W(t_0) \exp \left\{ - \int_{t_0}^t p(\tau) d\tau \right\}. \quad (4.5)$$

The constant

$$C := W(t_0) = y_1(t_0)y_2'(t_0) - y_1'(t_0)y_2(t_0)$$

depends on  $y_1$  and  $y_2$  (and  $t_0$ ). Thus, the Abel's formula is proved.

(c) If, at some point  $t_0$  in  $(a, b)$ ,  $W(t_0) = 0$ , then (4.5) implies that  $W(t) \equiv 0$ .

**34.** Using the superposition principle (see Problem 30), we conclude the following.

(a)  $y_1(t) = t^2 - t$  and  $y_2(t) = t^3 - t$  are solutions to the corresponding homogeneous equation. These two functions are linearly independent on any interval because their nontrivial linear combination

$$c_1 y_1 + c_2 y_2 = c_2 t^3 + c_1 t^2 - (c_1 + c_2) t$$

is a non-zero polynomial of degree at most three, which cannot have more than three zeros.

(b) A general solution to the given equation is a sum of a general solution  $y_h$  to the corresponding homogeneous equation and a particular solution to the nonhomogeneous equation, say,  $t$ . Hence,

$$y = t + c_1(t^2 - t) + c_2(t^3 - t)$$

## Chapter 4

$$\Rightarrow y' = 1 + c_1(2t - 1) + c_2(3t^2 - 1).$$

We now use the initial conditions to find  $c_1$  and  $c_2$ .

$$\begin{cases} 2 = y(2) = 2 + 2c_1 + 6c_2 \\ 5 = y'(2) = 1 + 3c_1 + 11c_2 \end{cases} \Rightarrow \begin{cases} c_1 + 3c_2 = 0 \\ 3c_1 + 11c_2 = 4. \end{cases}$$

Solving this system yields  $c_1 = -6$ ,  $c_2 = 2$ . Therefore, the answer is

$$y = t - 6(t^2 - t) + 2(t^3 - t) = 2t^3 - 6t^2 + 5t.$$

- (c) From Abel's formula (or see (4.4) in Problem 32) we have  $W'/W = -p$ , where  $W = W[y_1, y_2](t)$ . In this problem,

$$\begin{aligned} W[y_1, y_2](t) &= (t^2 - t)(t^3 - t)' - (t^2 - t)'(t^3 - t) \\ &= t^4 - 2t^3 + t^2 = t^2(t - 1)^2. \end{aligned}$$

Therefore,  $W' = 4t^3 - 6t^2 + 2t = 2t(t - 1)(2t - 1)$  and

$$p(t) = -\frac{2t(t - 1)(2t - 1)}{t^2(t - 1)^2} = \frac{2 - 4t}{t(t - 1)}.$$

We remark that one can now easily recover the "mysterious" equation. Indeed, substituting  $y_1(t)$  into the corresponding homogeneous equation yields

$$q(t) = \frac{6t^2 - 6t + 2}{t^2(t - 1)^2}.$$

Finally, the substitution  $y = t$  into the original nonhomogeneous equation gives

$$g(t) = \frac{2t}{(t - 1)^2}.$$

- 36.** Clearly,  $y_1(t)$  and  $y_2(t)$  are linearly independent since one of them is an exponential function and the other one is a polynomial. We now check if they satisfy the given equation.

$$\begin{aligned} t(e^t)'' - (t + 2)(e^t)' + 2(e^t) &= te^t - (t + 2)e^t + 2e^t = 0 \\ t(t^2 + 2t + 2)'' - (t + 2)(t^2 + 2t + 2)' + 2(t^2 + 2t + 2) \\ &= t(2) - (t + 2)(2t + 2) + 2(t^2 + 2t + 2) = 0. \end{aligned}$$

Therefore, a general solution has the form

$$y(t) = c_1e^t + c_2(t^2 + 2t + 2)$$

$$\Rightarrow y'(t) = c_1 e^t + c_2 (2t + 2).$$

For  $c_1$  and  $c_2$  we obtain the system of linear equations

$$\begin{cases} 0 = y(1) = c_1 e + 5c_2 \\ 1 = y'(1) = c_1 e + 4c_2. \end{cases}$$

Solving yields  $c_1 = 5/e$ ,  $c_2 = -1$ . Thus, the answer is

$$y = 5e^{t-1} - t^2 - 2t - 2.$$

**38.** In standard form, the equation becomes

$$y'' - \frac{4}{t} y' + \frac{6}{t^2} y = t + t^{-2}.$$

Thus,  $g(t) = t + t^{-2}$ . We are also given two linearly independent solutions to the corresponding homogeneous equation,  $y_1(t) = t^2$  and  $y_2(t) = t^3$ . Computing their Wronskian

$$W[y_1, y_2](t) = t^2(3t^2) - (2t)t^3 = t^4,$$

we can use Theorem 7 to find  $v_1(t)$  and  $v_2(t)$ .

$$\begin{aligned} v_1(t) &= \int \frac{-(t + t^{-2})t^3}{t^4} dt = - \int (1 + t^{-3}) dt = \frac{1}{2}t^{-2} - t, \\ v_2(t) &= \int \frac{(t + t^{-2})t^2}{t^4} dt = \int (t^{-1} + t^{-4}) dt = \ln t - \frac{1}{3}t^{-3}. \end{aligned}$$

Therefore,

$$y_p = v_1 y_1 + v_2 y_2 = \left(\frac{1}{2}t^{-2} - t\right)t^2 + \left(\ln t - \frac{1}{3}t^{-3}\right)t^3 = t^3 \ln t - t^3 + \frac{1}{6}$$

is a particular solution to the given equation. By the superposition principle, a general solution to the given equation is

$$y(t) = t^3 \ln t - t^3 + \frac{1}{6} + c_1 t^2 + c_2 t^3 = t^3 \ln t + \frac{1}{6} + c_1 t^2 + c_3 t^3,$$

where  $c_3 = c_2 - 1$ .

**40.** Writing the equation in standard form,

$$y'' + \frac{1-2t}{t} y' + \frac{t-1}{t} y = e^t,$$

## Chapter 4

we see that  $g(t) = e^t$ . We also have two linearly independent solutions to the corresponding homogeneous equation,  $y_1(t) = e^t$  and  $y_2(t) = e^t \ln t$ . Computing their Wronskian

$$W[y_1, y_2](t) = e^t (e^t \ln t)' - (e^t)' e^t \ln t = t^{-1} e^{2t},$$

we use Theorem 7 to find  $v_1(t)$  and  $v_2(t)$ .

$$\begin{aligned} v_1(t) &= - \int \frac{e^t e^t \ln t}{t^{-1} e^{2t}} dt = - \int t \ln t dt = -\frac{1}{2} t^2 \ln t + \frac{1}{4} t^2, \\ v_2(t) &= \int \frac{e^t e^t}{t^{-1} e^{2t}} dt = \int t dt = \frac{1}{2} t^2. \end{aligned}$$

Therefore,

$$y_p = \left( -\frac{1}{2} t^2 \ln t + \frac{1}{4} t^2 \right) e^t + \frac{1}{2} t^2 e^t \ln t = \frac{1}{4} t^2 e^t$$

is a particular solution to the given equation. By the superposition principle, a general solution to the given equation is

$$y(t) = \frac{1}{4} t^2 e^t + c_1 e^t + c_2 e^t \ln t.$$

- 42.** In notation of Definition 2,  $a = 1$ ,  $b = 3$ ,  $c = 1$ . Therefore, the auxiliary equation (7) becomes

$$r^2 + 2r + 1 = 0 \quad \Rightarrow \quad r = -1$$

is a double root. Hence,  $y_1(t) = t^{-1}$  and  $y_2(t) = t^{-1} \ln t$  are two linearly independent solutions to the corresponding homogeneous equation. Computing their Wronskian yields

$$W[y_1, y_2](t) = \begin{vmatrix} t^{-1} & t^{-1} \ln t \\ -t^{-2} & t^{-2}(1 - \ln t) \end{vmatrix} = t^{-3}.$$

The standard form of the given equation,

$$z'' - t^{-1} z' + t^{-2} z = t^{-1} \left( 1 + \frac{3}{\ln t} \right),$$

shows that  $g(t) = t^{-3}$ . We now apply formulas (12) to find a particular solution.

$$\begin{aligned} v_1(t) &= \int \frac{-t^{-3} t^{-1} \ln t}{t^{-3}} dt = - \int \frac{\ln t}{t} dt = -\frac{1}{2} \ln^2 t, \\ v_2(t) &= \int \frac{t^{-3} t^{-1}}{t^{-3}} dt = \int \frac{dt}{t} = \ln t. \end{aligned}$$

Thus,

$$y_p = v_1 y_1 + v_2 y_2 = \left( -\frac{1}{2} \ln^2 t \right) t^{-1} + (\ln t) t^{-1} \ln t = \frac{1}{2} t^{-1} \ln^2 t,$$

and a general solution to the given equation is given by

$$y = y_p + y_h = \frac{1}{2} t^{-1} \ln^2 t + c_1 t^{-1} + c_2 t^{-1} \ln t .$$

44. Since  $y_1(t) = t^{-1/2} \cos t$  and  $y_2(t) = t^{-1/2} \sin t$  are two linearly independent solutions to the homogeneous Bessel equation of order one-half, its general solution is given by

$$y_h = t^{-1/2} (c_1 \cos t + c_2 \sin t) .$$

The given equation is not in standard form. Dividing it by  $t^2$ , we find that  $g(t) = t^{1/2}$ . To find a particular solution, we use variation of parameters. First of all,

$$\begin{aligned} y_1'(t) &= (t^{-1/2} \cos t)' = -\frac{1}{2} t^{-3/2} \cos t - t^{-1/2} \sin t , \\ y_2'(t) &= (t^{-1/2} \sin t)' = -\frac{1}{2} t^{-3/2} \sin t + t^{-1/2} \cos t \end{aligned}$$

and so

$$\begin{aligned} W[y_1, y_2](t) &= t^{-1/2} \cos t \left( -\frac{1}{2} t^{-3/2} \sin t + t^{-1/2} \cos t \right) \\ &\quad - \left( -\frac{1}{2} t^{-3/2} \cos t - t^{-1/2} \sin t \right) t^{-1/2} \sin t = t^{-1} . \end{aligned}$$

We now involve Theorem 7 to find  $v_1$  and  $v_2$ .

$$\begin{aligned} v_1 &= \int \frac{-t^{1/2} t^{-1/2} \sin t}{t^{-1}} dt = - \int t \sin t dt = t \cos t - \sin t , \\ v_2 &= \int \frac{t^{1/2} t^{-1/2} \cos t}{t^{-1}} dt = \int t \cos t dt = t \sin t + \cos t , \end{aligned}$$

where we have used integration by parts and chose zero integration constants. Therefore,

$$y_p = (t \cos t - \sin t) t^{-1/2} \cos t + (t \sin t + \cos t) t^{-1/2} \sin t = t^{1/2}$$

and  $y = t^{1/2} + t^{-1/2} (c_1 \cos t + c_2 \sin t)$  is a general solution to the given nonhomogeneous Bessel's equation.

46. In standard form, the equation becomes

$$y'' + \frac{6}{t} y' + \frac{6}{t^2} y = 0 .$$

Thus,  $p(t) = 6/t$ . We also have a nontrivial solution  $y_1(t) = t^{-2}$ . To apply the reduction of order formula (13), we compute

$$\exp \left\{ - \int p(t) dt \right\} = \exp \left\{ - \int \frac{6 dt}{t} \right\} = \exp(-6 \ln t) = t^{-6} .$$



## Chapter 4

Hence, a second linearly independent solution is

$$y_2(t) = t^{-2} \int \frac{t^{-6} dt}{(t^{-2})^2} = t^{-2} \int t^{-2} dt = -t^{-3}.$$

One can also take  $y_2(t) = t^{-3}$ , because the given equation is linear and homogeneous.

48. Putting the equation in standard form yields  $p(t) = t^{-1} - 2$ . Hence,

$$\exp \left\{ - \int p(t) dt \right\} = \exp \left\{ \int (2 - t^{-1}) dt \right\} = e^{2t - \ln t} = t^{-1} e^{2t}.$$

Therefore, by Theorem 8, a second linearly independent solution is

$$y_2(t) = e^t \int \frac{t^{-1} e^{2t}}{(e^t)^2} dt = e^t \int t^{-1} dt = e^t \ln t.$$

50. Separation variables in (16) yields

$$\frac{w'}{w} = -\frac{2y_1' + py_1}{y_1} = -\left(2\frac{y_1'}{y_1} + p\right).$$

Integrating, we obtain

$$\begin{aligned} \int \frac{w'}{w} dt &= - \int \left(2\frac{y_1'}{y_1} + p\right) dt = -2 \int \frac{y_1'}{y_1} dt - \int p dt \\ \Rightarrow \ln |w| &= -2 \ln |y_1| - \int p dt \quad \Rightarrow \quad |w| = y_1^{-2} \exp \left\{ - \int p dt \right\}. \end{aligned}$$

Obviously,  $w(t)$  does not change its sign on  $I$  (the right-hand side does not vanish on  $I$ ). Without loss of generality, we can assume that  $w > 0$  on  $I$  and so

$$\begin{aligned} v' = w &= y_1^{-2} \exp \left\{ - \int p dt \right\} \\ \Rightarrow v &= \int \frac{\exp \left\{ - \int p dt \right\}}{y_1^2} dt \quad \Rightarrow \quad y_2 = y_1 v = y_1 \int \frac{\exp \left\{ - \int p dt \right\}}{y_1^2} dt. \end{aligned}$$

52. For  $y(t) = v(t)f(t) = tv(t)$ , we find

$$\begin{aligned} y' &= tv' + v, \\ y'' &= tv'' + 2v', \\ y''' &= tv''' + 3v''. \end{aligned}$$

Substituting  $y$  and its derivatives into the given equation, we get

$$t(tv''' + 3v'') + (1-t)(tv'' + 2v') + t(tv' + v) - tv$$

$$= t^2 v''' - (t^2 - 4t)v'' + (t^2 - 2t + 2)v' = 0.$$

Hence, denoting  $v' = w$  (so that  $v'' = w'$  and  $v''' = w''$ ) yields

$$t^2 w'' - (t^2 - 4t)w' + (t^2 - 2t + 2)w = 0,$$

which is a second order linear homogeneous equation in  $w$ .

54. The quotient rule, the definition of the Wronskian (see Problem 34, Section 4.2), and Abel's formula (Problem 32) give us

$$\left(\frac{y}{f}\right)' = \frac{fy' - f'y}{f^2} = \frac{W[f, y]}{f^2} = \frac{C \exp\left\{-\int_{t_0}^t p(\tau)d\tau\right\}}{f^2}.$$

Integrating yields

$$\begin{aligned} \int \left(\frac{y}{f}\right)' dt &= C \int \frac{\exp\left\{-\int_{t_0}^t p(\tau)d\tau\right\}}{f^2} dt \\ \Rightarrow \frac{y}{f} &= C \int \frac{\exp\left\{-\int_{t_0}^t p(\tau)d\tau\right\}}{f^2} dt \\ \Rightarrow y &= C f \int \frac{\exp\left\{-\int_{t_0}^t p(\tau)d\tau\right\}}{f^2} dt = C_1 f \int \frac{\exp\left\{-\int p(\tau)d\tau\right\}}{f^2} dt, \end{aligned}$$

where  $C_1$  depends on  $C$  and the constant of integration. Since the given differential equation is linear and homogeneous,

$$y_2 := \frac{y}{C_1} = f \int \frac{\exp\left\{-\int p(\tau)d\tau\right\}}{f^2} dt$$

is also a solution. Clearly,  $f$  and  $y_2$  are linearly independent because  $f$  and  $y$  are and  $y_2$  is a constant multiple of  $y$ .

### EXERCISES 4.8: Qualitative Considerations for Variable-Coefficient and Nonlinear Equations

2. Comparing the given equation with (13), we conclude that

$$\text{“inertia”} = 1, \quad \text{“damping”} = 0, \quad \text{“stiffness”} = -6y.$$

If  $y > 0$ , then the stiffness is negative. Negative stiffness tends to reinforce the displacement with the force  $F_{\text{spring}} = 6y$  that intensifies as the displacement increases. Thus, the solutions must increase unboundedly.

## Chapter 4

4. Assuming that a linear combination

$$\frac{c_1}{(1-t)^2} + \frac{c_2}{(2-t)^2} + \frac{c_3}{(3-t)^2} = 0 \quad \text{on } (-1, 1),$$

we multiply this equality by  $(1-t)^2(2-t)^2(3-t)^2$  and conclude that

$$c_1(2-t)^2(3-t)^2 + c_2(1-t)^2(3-t)^2 + c_3(1-t)^2(2-t)^2 = 0 \quad \text{on } (-1, 1).$$

The left-hand side of the above equation is a polynomial of degree at most four, which can have four zeros at most, unless it is the zero polynomial. Equating the first three coefficients to zero yields the following homogeneous system of linear equations

$$\begin{aligned}c_1 + c_2 + c_3 &= 0 \\10c_1 + 8c_2 + 6c_3 &= 0 \\17c_1 + 10c_2 + 5c_3 &= 0\end{aligned}$$

for  $c_1$ ,  $c_2$ , and  $c_3$ , which has the unique trivial solution  $c_1 = c_2 = c_3 = 0$ . Thus, the given three functions are linearly independent.

6. Writing the given mass-spring equation in the form (7), we conclude that  $f(y) = -ky$  so that

$$F(y) = \int (-ky) = -\frac{ky^2}{2}.$$

Therefore, the energy equation (8) becomes

$$E(t) = \frac{1}{2} y'(t)^2 - \left( -\frac{ky(t)^2}{2} \right) = C_1 \quad \Rightarrow \quad y'(t)^2 + ky(t)^2 = C.$$

8. In this problem, the dependent variable is  $\theta$  and the independent variable is  $t$ . From the pendulum equation (21), we find that  $f(\theta) = -(g/\ell) \sin \theta$ . Thus,

$$F(\theta) = \int \left( -\frac{g}{\ell} \sin \theta \right) d\theta = \frac{g}{\ell} \cos \theta,$$

and the energy equation (8) becomes

$$E(t) = \frac{1}{2} \theta'(t)^2 - \frac{g}{\ell} \cos \theta(t) = C. \tag{4.6}$$

10. Substituting  $t = 0$  into (4.6) and using the initial conditions

$$\theta(0) = \alpha, \quad \theta'(0) = 0$$

yields

$$C = \frac{1}{2} \theta'(0)^2 - \frac{g}{\ell} \cos \theta(0) = -\frac{g}{\ell} \cos \alpha.$$

Writing now (4.6) as

$$\frac{g}{\ell} \cos \theta(t) - \frac{1}{2} \theta'(t)^2 = \frac{g}{\ell} \cos \alpha,$$

we see that, for all  $t$ ,

$$\cos \theta(t) \geq \cos \alpha$$

since  $\theta'(t)^2$  is nonnegative. Solving this inequality on  $[-\pi, \pi]$  yields

$$|\theta(t)| \leq \cos^{-1}(\cos \alpha) = \alpha.$$

**12.** Writing the Legendre's equation (2) in standard form

$$y'' - \frac{2t}{1-t^2} y' + \frac{2}{1-t^2} y = 0$$

yields

$$p(t) = \frac{2t}{t^2 - 1} \quad \Rightarrow \quad \int p(t) dt = \ln(1 - t^2), \quad -1 < t < 1.$$

Therefore, with  $y_1(t) = t$ ,

$$\begin{aligned} \int \frac{\exp\{-\int p(t) dt\}}{y_1(t)^2} dt &= \int \frac{dt}{t^2(1-t^2)} = \int \frac{(1-t^2+t^2) dt}{t^2(1-t^2)} \\ &= \int \frac{dt}{t^2} + \int \frac{dt}{1-t^2} = -\frac{1}{t} + \frac{1}{2} \ln\left(\frac{1+t}{1-t}\right), \end{aligned}$$

and the reduction of order formula (13), Section 4.7, gives

$$y_2(t) = y_1(t) \int \frac{\exp\{-\int p(t) dt\}}{y_1(t)^2} dt = t \left[ -\frac{1}{t} + \frac{1}{2} \ln\left(\frac{1+t}{1-t}\right) \right] = \frac{t}{2} \ln\left(\frac{1+t}{1-t}\right) - 1.$$

**14.** With  $n = 1/2$ , the Bessel's equation(16) reads

$$y'' + \frac{1}{t} y' + \left(1 - \frac{1}{4t^2}\right) y = 0. \quad (4.7)$$

Since the Bessel's equation is linear and homogeneous, we will check whether or not

$$y_1(t) := t^{-1/2} \sin t \quad \text{and} \quad y_2(t) := t^{-1/2} \cos t$$

are solutions. If they are, then  $J_{1/2}(t)$  and  $Y_{1/2}(t)$  are solutions as well. For  $y_1(t)$ , we have

$$y_1'(t) = t^{-1/2} \cos t - \frac{1}{2} t^{-3/2} \sin t,$$

## Chapter 4

$$y_1''(t) = -t^{-1/2} \sin t - t^{-3/2} \cos t + \frac{3}{4} t^{-5/2} \sin t.$$

Substituting these expressions into (4.7) and collecting similar terms yields

$$\begin{aligned} \left( -t^{-1/2} \sin t - t^{-3/2} \cos t + \frac{3}{4} t^{-5/2} \sin t \right) + \left( t^{-3/2} \cos t - \frac{1}{2} t^{-5/2} \sin t \right) \\ + \left( t^{-1/2} \sin t - \frac{1}{4} t^{-5/2} \sin t \right) = 0. \end{aligned}$$

Similarly, for  $y_2(t)$ , we have

$$\begin{aligned} y_2'(t) &= -t^{-1/2} \sin t - \frac{1}{2} t^{-3/2} \cos t, \\ y_2''(t) &= -t^{-1/2} \cos t + t^{-3/2} \sin t + \frac{3}{4} t^{-5/2} \cos t. \end{aligned}$$

Substituting these expressions into (4.7) and collecting similar terms, we get

$$\begin{aligned} \left( -t^{-1/2} \cos t + t^{-3/2} \sin t + \frac{3}{4} t^{-5/2} \cos t \right) + \left( -t^{-3/2} \sin t - \frac{1}{2} t^{-5/2} \cos t \right) \\ + \left( t^{-1/2} \cos t - \frac{1}{4} t^{-5/2} \cos t \right) = 0. \end{aligned}$$

Hence,  $y_1(t)$  and  $y_2(t)$  are solutions to (4.7).

**16.** For the Duffing equation (18),  $f(y) = -(y + y^3)$  in the energy lemma so that

$$F(y) = - \int (y + y^3) dy = - \left( \frac{y^2}{2} + \frac{y^4}{4} \right) \Rightarrow E(t) = \frac{1}{2} y'(t)^2 + \frac{y(t)^2}{2} + \frac{y(t)^4}{4} = C.$$

Therefore, since  $(1/2)y'(t)^2 + (1/4)y(t)^4 \geq 0$ ,

$$y(t)^2 \leq 2C \quad \Rightarrow \quad |y(t)| \leq \sqrt{2C} =: M.$$

### EXERCISES 4.9: A Closer Look at Free Mechanical Vibrations

**2.** In this problem, we have undamped free vibration case governed by equation (2) in the text. With  $m = 2$  and  $k = 50$ , the equation becomes

$$2y'' + 50y = 0$$

with the initial conditions  $y(0) = -1/4$ ,  $y'(0) = -1$ .

The angular velocity of the motion is

$$\omega = \sqrt{\frac{k}{m}} = \sqrt{\frac{50}{2}} = 5.$$

It follows that

$$\begin{aligned}\text{period} &= \frac{2\pi}{\omega} = \frac{2\pi}{5} \\ \text{natural frequency} &= \frac{\omega}{2\pi} = \frac{5}{2\pi}.\end{aligned}$$

A general solution, given in (4) in the text, becomes

$$y(t) = C_1 \cos \omega t + C_2 \sin \omega t = C_1 \cos 5t + C_2 \sin 5t.$$

We find  $C_1$  and  $C_2$  from the initial conditions.

$$\begin{aligned}y(0) &= (C_1 \cos 5t + C_2 \sin 5t) \Big|_{t=0} = C_1 = -1/4 \\ y'(0) &= (-5C_1 \sin 5t + 5C_2 \cos 5t) \Big|_{t=0} = 5C_2 = -1\end{aligned} \quad \Rightarrow \quad \begin{aligned}C_1 &= -1/4 \\ C_2 &= -1/5.\end{aligned}$$

Thus, the solution to the initial value problem is

$$y(t) = -\frac{1}{4} \cos 5t - \frac{1}{5} \sin 5t.$$

The amplitude of the motion therefore is

$$A = \sqrt{C_1^2 + C_2^2} = \sqrt{\frac{1}{16} + \frac{1}{25}} = \frac{\sqrt{41}}{20}.$$

Setting  $y = 0$  in the above solution, we find values of  $t$  when the mass passes through the point of equilibrium.

$$\begin{aligned}-\frac{1}{4} \cos 5t - \frac{1}{5} \sin 5t &= 0 & \Rightarrow & \quad \tan 5t = -\frac{5}{4} \\ & & \Rightarrow & \quad t = \frac{\pi k - \arctan(5/4)}{5}, \quad k = 1, 2, \dots\end{aligned}$$

(Time  $t$  is nonnegative.) The first moment when this happens, i.e., the smallest value of  $t$ , corresponds to  $k = 1$ . So,

$$t = \frac{\pi - \arctan(5/4)}{5} \approx 0.45 \text{ (sec)}.$$

4. The characteristic equation in this problem,  $r^2 + br + 64 = 0$ , has the roots

$$r = \frac{-b \pm \sqrt{b^2 - 256}}{2}.$$

Substituting given particular values of  $b$ , we find the roots of the characteristic equation and solutions to the initial value problems in each case.

## Chapter 4

**b = 0.**

$$r = \frac{\pm\sqrt{-256}}{2} = \pm 8i.$$

A general solution has the form  $y = C_1 \cos 8t + C_2 \sin 8t$ . Constants  $C_1$  and  $C_2$  can be found from the initial conditions.

$$\begin{aligned} y(0) &= (C_1 \cos 8t + C_2 \sin 8t) \Big|_{t=0} = C_1 = 1 \\ y'(0) &= (-8C_1 \sin 8t + 8C_2 \cos 8t) \Big|_{t=0} = 8C_2 = 0 \end{aligned} \quad \Rightarrow \quad \begin{aligned} C_1 &= 1 \\ C_2 &= 0 \end{aligned}$$

and so  $y(t) = \cos 8t$ .

**b = 10.**

$$r = \frac{-10 \pm \sqrt{100 - 256}}{2} = -5 \pm \sqrt{39}i.$$

A general solution has the form  $y = (C_1 \cos \sqrt{39}t + C_2 \sin \sqrt{39}t)e^{-5t}$ . For constants  $C_1$  and  $C_2$ , we have the system

$$\begin{aligned} y(0) &= (C_1 \cos \sqrt{39}t + C_2 \sin \sqrt{39}t) e^{-5t} \Big|_{t=0} = C_1 = 1 \\ y'(0) &= [(\sqrt{39}C_2 - 5C_1) \cos \sqrt{39}t - (\sqrt{39}C_1 + 5C_2) \sin \sqrt{39}t] e^{-5t} \Big|_{t=0} \\ &= \sqrt{39}C_2 - 5C_1 = 0 \end{aligned}$$

$$\Rightarrow \quad \begin{aligned} C_1 &= 1 \\ C_2 &= 5/\sqrt{39}, \end{aligned}$$

and so

$$y(t) = \left[ \cos \sqrt{39}t + \frac{5}{\sqrt{39}} \sin \sqrt{39}t \right] e^{-5t} = \frac{8}{\sqrt{39}} e^{-5t} \sin \left( \sqrt{39}t + \phi \right),$$

where  $\phi = \arctan(\sqrt{39}/5) \approx 0.896$ .

**b = 16.**

$$r = \frac{-16 \pm \sqrt{256 - 256}}{2} = -8.$$

Thus,  $r = -8$  is a double root of the characteristic equation. So, a general solution has the form  $y = (C_1 t + C_0)e^{-8t}$ . For constants  $C_1$  and  $C_2$ , we obtain the system

$$\begin{aligned} y(0) &= (C_1 t + C_0) e^{-8t} \Big|_{t=0} = C_0 = 1 \\ y'(0) &= (-8C_1 t - 8C_0 + C_1) e^{-8t} \Big|_{t=0} = C_1 - 8C_0 = 0 \end{aligned} \quad \Rightarrow \quad \begin{aligned} C_0 &= 1, \\ C_1 &= 8, \end{aligned}$$

and so  $y(t) = (8t + 1)e^{-8t}$ .

**b = 20.**

$$r = \frac{-20 \pm \sqrt{400 - 256}}{2} = -10 \pm 6.$$

Thus,  $r = -4, -16$ , and a general solution is given by  $y = C_1e^{-4t} + C_2e^{-16t}$ . The initial conditions give the system

$$\begin{aligned} y(0) &= (C_1e^{-4t} + C_2e^{-16t}) \Big|_{t=0} = C_1 + C_2 = 1 \\ y'(0) &= (-4C_1e^{-4t} - 16C_2e^{-16t}) \Big|_{t=0} = -4C_1 - 16C_2 = 0 \end{aligned} \quad \Rightarrow \quad \begin{aligned} C_1 &= 4/3 \\ C_2 &= -1/3, \end{aligned}$$

and, therefore,  $y(t) = (4/3)e^{-4t} - (1/3)e^{-16t}$  is the solution.

The graphs of the solutions are depicted in Fig. 4–D and Fig. 4–E, page 174.

6. The auxiliary equation associated with given differential equation is  $r^2 + 4r + k = 0$ , and its roots are  $r = -2 \pm \sqrt{4 - k}$ .

**k = 2.** In this case,  $r = -2 \pm \sqrt{4 - 2} = -2 \pm \sqrt{2}$ . Thus, a general solution is given by  $y = C_1e^{(-2+\sqrt{2})t} + C_2e^{(-2-\sqrt{2})t}$ . The initial conditions imply that

$$\begin{aligned} y(0) &= \left[ C_1e^{(-2+\sqrt{2})t} + C_2e^{(-2-\sqrt{2})t} \right] \Big|_{t=0} = C_1 + C_2 = 1 \\ y'(0) &= \left[ (-2 + \sqrt{2})C_1e^{(-2+\sqrt{2})t} + (-2 - \sqrt{2})C_2e^{(-2-\sqrt{2})t} \right] \Big|_{t=0} \\ &= (-2 + \sqrt{2})C_1 + (-2 - \sqrt{2})C_2 = 0 \\ \Rightarrow \quad C_1 &= (1 + \sqrt{2})/2, \quad C_2 = (1 - \sqrt{2})/2 \end{aligned}$$

and, therefore,

$$y(t) = \frac{1 + \sqrt{2}}{2} e^{(-2+\sqrt{2})t} + \frac{1 - \sqrt{2}}{2} e^{(-2-\sqrt{2})t}$$

is the solution to the initial value problem.

**k = 4.** Then  $r = -2 \pm \sqrt{4 - 4} = -2$ . Thus,  $r = -2$  is a double root of the characteristic equation. So, a general solution has the form  $y = (C_1t + C_0)e^{-2t}$ . For constants  $C_1$  and  $C_2$ , using the initial conditions, we obtain the system

$$\begin{aligned} y(0) &= (C_1t + C_0)e^{-2t} \Big|_{t=0} = C_0 = 1 \\ y'(0) &= (-2C_1t - 2C_0 + C_1)e^{-2t} \Big|_{t=0} = C_1 - 2C_0 = 0 \end{aligned} \quad \Rightarrow \quad \begin{aligned} C_0 &= 1, \\ C_1 &= 2 \end{aligned}$$

and so  $y(t) = (2t + 1)e^{-2t}$ .

**k = 6.** In this case,  $r = -2 \pm \sqrt{4 - 6} = -2 \pm \sqrt{2}i$ . A general solution has the form

$$y = (C_1 \cos \sqrt{2}t + C_2 \sin \sqrt{2}t)e^{-2t}$$



## Chapter 4

$$\Rightarrow y' = \left[ (\sqrt{2}C_2 - 2C_1) \cos \sqrt{2}t - (\sqrt{2}C_1 + 2C_2) \sin \sqrt{2}t \right] e^{-2t}.$$

For constants  $C_1$  and  $C_2$ , we have the system

$$\begin{aligned} y(0) &= (C_1 \cos 0 + C_2 \sin 0) e^0 = C_1 = 1 \\ y'(0) &= [(\sqrt{2}C_2 - 2C_1) \cos 0 - (\sqrt{2}C_1 + 2C_2) \sin 0] e^0 = \sqrt{2}C_2 - 2C_1 = 0 \\ \Rightarrow C_1 &= 1, \quad C_2 = \sqrt{2}, \end{aligned}$$

and so

$$y(t) = \left[ \cos \sqrt{2}t + \sqrt{2} \sin \sqrt{2}t \right] e^{-2t} = \sqrt{3} e^{-2t} \sin(\sqrt{2}t + \phi),$$

where  $\phi = \arctan(1/\sqrt{2}) \approx 0.615$ .

Graphs of the solutions for  $k = 2, 4$ , and  $6$  are shown in Fig. **4-F** on page 175.

8. The motion of this mass-spring system is governed by equation (12) in the text. With  $m = 20$ ,  $b = 140$ , and  $k = 200$  this equation becomes

$$20y'' + 140y' + 200y = 0 \quad \Rightarrow \quad y'' + 7y' + 10y = 0,$$

and the initial conditions are  $y(0) = 1/4$ ,  $y'(0) = -1$ . Since

$$b^2 - 4mk = 49 - 4 \cdot 10 = 9 > 0,$$

we have a case of overdamped motion.

The characteristic equation,  $r^2 + 7r + 10 = 0$  has roots  $r = -2, -5$ . Thus, a general solution is given by

$$y(t) = C_1 e^{-2t} + C_2 e^{-5t}.$$

To satisfy the initial conditions, we solve the system

$$\begin{aligned} y(0) &= C_1 + C_2 = 1/4 \\ y'(0) &= -2C_1 - 5C_2 = -1 \end{aligned} \quad \Rightarrow \quad \begin{aligned} C_1 &= 1/12 \\ C_2 &= 1/6. \end{aligned}$$

Therefore, the equation of motion is

$$y(t) = \frac{1}{12} e^{-2t} + \frac{1}{6} e^{-5t},$$

which says that, theoretically, the mass will never return to its equilibrium.

10. This motion is governed by the equation

$$\frac{1}{4} \frac{d^2 y}{dt^2} + \frac{1}{4} \frac{dy}{dt} + 8y = 0 \quad \Rightarrow \quad \frac{d^2 y}{dt^2} + \frac{dy}{dt} + 32y = 0,$$

with initial conditions  $y(0) = -1$ ,  $y'(0) = 0$ . The auxiliary equation,  $r^2 + r + 32 = 0$ , has roots

$$r = \frac{-1 \pm \sqrt{127}i}{2}.$$

Therefore, the equation of motion has the form

$$y(t) = e^{-t/2} \left[ C_1 \cos \left( \frac{\sqrt{127}}{2} t \right) + C_2 \sin \left( \frac{\sqrt{127}}{2} t \right) \right].$$

To find the constants  $C_1$  and  $C_2$ , we use the initial conditions  $y(0) = -1$  and  $y'(0) = 0$ . Since

$$y'(t) = e^{-t/2} \left[ \left( \frac{\sqrt{127}}{2} C_2 - \frac{1}{2} C_1 \right) \cos \left( \frac{\sqrt{127}}{2} t \right) - \left( \frac{\sqrt{127}}{2} C_1 + \frac{1}{2} C_2 \right) \sin \left( \frac{\sqrt{127}}{2} t \right) \right],$$

we obtain the system

$$\begin{aligned} y(0) = C_1 &= -1 & \Rightarrow & C_1 = -1 \\ y'(0) = (\sqrt{127}/2) C_2 - (1/2) C_1 &= 0 & \Rightarrow & C_2 = -1/\sqrt{127}. \end{aligned}$$

Therefore,

$$y(t) = -e^{-t/2} \left[ \cos \left( \frac{\sqrt{127}}{2} t \right) + \frac{1}{\sqrt{127}} \sin \left( \frac{\sqrt{127}}{2} t \right) \right].$$

The maximum displacement to the right of the mass is found by determining the first time  $t^* > 0$  the velocity of the mass becomes zero. Since

$$y'(t) = \frac{64}{\sqrt{127}} e^{-t/2} \sin \left( \frac{\sqrt{127}}{2} t \right),$$

we have

$$\frac{\sqrt{127}}{2} t^* = \pi \quad \Rightarrow \quad t^* = \frac{2\pi}{\sqrt{127}}.$$

Substituting this value into  $y(t)$  yields the maximal displacement

$$y(t^*) = e^{-\pi/\sqrt{127}} \approx 0.757 \text{ (m)}.$$

## Chapter 4

**12.** The equation of the motion of this mass-spring system is

$$(1/4)y'' + 2y' + 8y = 0, \quad y(0) = -1/2, \quad y'(0) = -2.$$

Clearly, this is an underdamped motion because

$$b^2 - 4mk = (2)^2 - 4(1/4)(8) = -4 < 0.$$

So, we use equation (16) in the text for a general solution. With

$$\alpha = -\frac{b}{2m} = -\frac{2}{(1/2)} = -4 \quad \text{and} \quad \beta = \frac{1}{2m} \sqrt{4mk - b^2} = 2\sqrt{4} = 4,$$

equation (16) becomes  $y(t) = (C_1 \cos 4t + C_2 \sin 4t) e^{-4t}$ . From the initial conditions,

$$\begin{aligned} y(0) &= (C_1 \cos 4t + C_2 \sin 4t) e^{-4t} \Big|_{t=0} = C_1 = -1/2 \\ y'(0) &= [(4(C_2 - C_1) \cos 4t - 4(C_1 + C_2) \sin 4t) e^{-4t}] \Big|_{t=0} = 4(C_2 - C_1) = -2 \\ \Rightarrow \quad C_1 &= -1/2, \quad C_2 = -1, \end{aligned}$$

and so

$$y(t) = -\left(\frac{1}{2} \cos 4t + \sin 4t\right) e^{-4t}.$$

The maximum displacement to the left occurs at the first point  $t^*$  of local minimum of  $y(t)$ . The critical points of  $y(t)$  are solutions to

$$y'(t) = -2e^{-4t} (\cos 4t - 3 \sin 4t) = 0.$$

Solving for  $t$ , we conclude that the first point of local minimum is at

$$t^* = \frac{\arctan(1/3)}{4} \approx 0.08 \text{ (sec)}.$$

**14.** For the damping factor,  $Ae^{-(b/2m)t}$ ,

$$\lim_{b \rightarrow 0} Ae^{-(b/2m)t} = Ae^{-(0/2m)t} = Ae^0 = A$$

since the exponential function is continuous on  $(-\infty, \infty)$ .

For the quasifrequency, we have

$$\lim_{b \rightarrow 0} \frac{\sqrt{4mk - b^2}}{4m\pi} = \frac{\sqrt{4mk}}{4m\pi} = \frac{\sqrt{(4mk)/(2m)^2}}{2\pi} = \frac{\sqrt{k/m}}{2\pi}.$$

16. Since the period  $P = 2\pi/\omega = 2\pi\sqrt{m/k}$ , we have a system of two equations to determine  $m$  (and  $k$ ).

$$\begin{cases} 2\pi\sqrt{\frac{m}{k}} = 3 \\ 2\pi\sqrt{\frac{m+2}{k}} = 4. \end{cases}$$

Dividing the second equation by the first one, we eliminate  $k$  and get

$$\sqrt{\frac{m+2}{m}} = \frac{4}{3} \Rightarrow \frac{m+2}{m} = \frac{16}{9} \Rightarrow 9m+18 = 16m \Rightarrow m = \frac{18}{7} \text{ (kg)}.$$

18. As it was noticed in the discussion concerning an overdamped motion, a general solution to the equation  $my'' + by' + ky = 0$  has the form

$$y(t) = C_1e^{r_1t} + C_2e^{r_2t} \quad (r_2 < r_1 < 0) \Rightarrow y'(t) = C_1r_1e^{r_1t} + C_2r_2e^{r_2t}.$$

From the initial conditions, we have a system of linear inequalities

$$\begin{cases} y(0) = C_1 + C_2 > 0, \\ y'(0) = C_1r_1 + C_2r_2 > 0. \end{cases} \quad (4.8)$$

Multiplying the first inequality in (4.8) by  $r_1$  and subtracting the result from the second one, we obtain

$$C_2(r_2 - r_1) > 0 \Rightarrow C_2 < 0 \Rightarrow C_1 > -C_2 > 0.$$

Moreover, the first inequality in (4.8) now implies that

$$\frac{-C_2}{C_1} < 1. \quad (4.9)$$

If the mass is in the equilibrium position, then

$$y(t) = C_1e^{r_1t} + C_2e^{r_2t} = 0 \Leftrightarrow C_1e^{(r_1-r_2)t} + C_2 = 0 \Leftrightarrow e^{(r_1-r_2)t} = \frac{-C_2}{C_1}.$$

Since  $r_1 - r_2 > 0$ , this equation has no solutions for  $t > 0$  thanks to (4.9).

### EXERCISES 4.10: A Closer Look at Forced Mechanical Vibrations

2. The frequency response curve (13), with  $m = 2$ ,  $k = 3$ , and  $b = 3$ , becomes

$$M(\gamma) = \frac{1}{\sqrt{(k - m\gamma^2)^2 + b^2\gamma^2}} = \frac{1}{\sqrt{(3 - 2\gamma^2)^2 + 9\gamma^2}}.$$

The graph of this function is shown in Fig. 4-G, page 175.

## Chapter 4

4. The auxiliary equation in this problem is  $r^2 + 1 = 0$ , which has roots  $r = \pm i$ . Thus, a general solution to the corresponding homogeneous equation has the form

$$y_h(t) = C_1 \cos t + C_2 \sin t.$$

We look for a particular solution to the original nonhomogeneous equation of the form

$$y_p(t) = t^s(A \cos t + B \sin t),$$

where we take  $s = 1$  because  $r = i$  is a simple root of the auxiliary equation. Computing the derivatives

$$\begin{aligned}y'(t) &= A \cos t + B \sin t + t(-A \sin t + B \cos t), \\y''(t) &= 2B \cos t - 2A \sin t + t(-A \cos t - B \sin t),\end{aligned}$$

and substituting  $y(t)$  and  $y''(t)$  into the original equation, we get

$$\begin{aligned}2B \cos t - 2A \sin t + t(-A \cos t - B \sin t) + t(A \cos t + B \sin t) &= 5 \cos t \\ \Rightarrow \quad 2B \cos t - 2A \sin t = 5 \cos t &\quad \Rightarrow \quad \begin{aligned}A &= 0, \\ B &= 5/2.\end{aligned}\end{aligned}$$

So,  $y_p(t) = (5/2)t \sin t$  and  $y(t) = C_1 \cos t + C_2 \sin t + (5/2)t \sin t$  is a general solution.

To satisfy the initial conditions, we compute

$$\begin{aligned}y(0) &= C_1 = 0, \\y'(0) &= C_2 = 1.\end{aligned}$$

Therefore, the solution to the given initial value problem is

$$y(t) = \sin t + \frac{5}{2}t \sin t.$$

The graph of  $y(t)$  is depicted in Fig. 4–H on page 175.

6. Differentiating  $y_p(t)$  given by (20) in the text yields

$$\begin{aligned}y'_p(t) &= A_1 \cos \omega t + A_2 \sin \omega t + \omega t(-A_1 \sin \omega t + A_2 \cos \omega t), \\y''_p(t) &= -2A_1\omega \sin \omega t + 2A_2\omega \cos \omega t + \omega^2 t(-A_1 \cos \omega t - A_2 \sin \omega t).\end{aligned}$$

Substituting  $y_p(t)$  and  $y''(t)$  (with  $\gamma = \omega = \sqrt{k/m}$ ) into (18), we obtain

$$m \left[ -2A_1\omega \sin \omega t + 2A_2\omega \cos \omega t + \omega^2 t(-A_1 \cos \omega t - A_2 \sin \omega t) \right]$$

$$\begin{aligned}
& +kt(A_1 \cos \omega t + A_2 \sin \omega t) = F_0 \cos \omega t \\
\Rightarrow & (2m\omega A_2 - m\omega^2 A_1 t + kA_1 t) \cos \omega t + (-2m\omega A_1 + m\omega^2 A_2 t + kA_2 t) \sin \omega t \\
& = F_0 \cos \omega t \\
\Rightarrow & 2m\omega A_2 \cos \omega t - 2m\omega A_1 \sin \omega t = F_0 \cos \omega t.
\end{aligned}$$

Equating coefficients, we find that

$$A_1 = 0, \quad A_2 = \frac{F_0}{2m\omega}.$$

Therefore,

$$y_p(t) = \frac{F_0}{2m\omega} t \sin \omega t.$$

8. With the given values of parameters, the equation (1) becomes

$$2y'' + 8y' + 6y = 18 \quad \Rightarrow \quad y'' + 4y' + 3y = 9. \quad (4.10)$$

Solving the characteristic equation yields

$$r^2 + 4r + 3 = 0 \quad \Rightarrow \quad r = -3, -1.$$

Thus,  $y_h(t) = c_1 e^{-3t} + c_2 e^{-t}$  is a general solution to the corresponding homogeneous equation. Applying the method of undetermined coefficients (Section 4.4), we seek a particular solution of the form  $y_p(t) = A$ . From (4.10) one easily gets  $A = 3$ . Thus,

$$y(t) = c_1 e^{-3t} + c_2 e^{-t} + 3$$

is a general solution. We now satisfy the initial conditions.

$$\begin{aligned}
0 = y(0) = c_1 + c_2 + 3 & \Rightarrow -3 = c_1 + c_2 & \Rightarrow c_1 = \frac{3}{2}, c_2 = -\frac{9}{2}. \\
0 = y'(0) = -3c_1 - c_2 & \Rightarrow 0 = -3c_1 - c_2
\end{aligned}$$

Hence,  $y(t) = (3/2)e^{-3t} - (9/2)e^{-t} + 3$  is the solution to the given initial value problem.

The graph of  $y(t)$  is depicted in Fig. 4-I on page 176. Clearly,

$$\lim_{t \rightarrow \infty} y(t) = \lim_{t \rightarrow \infty} \left( \frac{3}{2} e^{-3t} - \frac{9}{2} e^{-t} + 3 \right) = 3. \quad (4.11)$$

From the physics point of view, the graph of  $y(t)$  and (4.11) mean that the external force  $F_{\text{ext}} = 18$  steadily stretches the spring to the length at equilibrium, which is  $y(\infty) = 3$  beyond its natural length.

## Chapter 4

10. If, at equilibrium, a mass of  $m$  kg stretches a spring by  $\ell$  m beyond its natural length, then the Hook's law states that

$$mg = k\ell \quad \Rightarrow \quad k = \frac{mg}{\ell}.$$

Therefore,  $\omega = \sqrt{k/m} = \sqrt{g/\ell}$  so that the period

$$T = \frac{2\pi}{\omega} = 2\pi\sqrt{\frac{\ell}{g}}.$$

12. First, we find the spring constant. Since, at equilibrium, the spring is stretched  $\ell = 0.2$  m from its natural length by the mass of  $m = 2$  kg, we have

$$mg = k\ell \quad \Rightarrow \quad k = \frac{mg}{\ell} \quad \Rightarrow \quad k = \frac{mg}{\ell} = 10g \text{ (N/m)}.$$

Thus, with  $b = 5$  N-sec/m and  $F_{\text{ext}}(t) = 0.3 \cos t$  N, the equation, governing the motion, becomes

$$2y'' + 5y' + 10gy = 0.3 \cos t. \quad (4.12)$$

In addition, we have initial conditions  $y(0) = 0.05$ ,  $y'(0) = 0$ .

The auxiliary equation for the corresponding homogeneous equation is  $2r^2 + 5r + 10g = 0$ , which has roots

$$r = \frac{-5 \pm \sqrt{25 - 80g}}{4} = -1.25 \pm \beta i, \quad \beta = \frac{\sqrt{80g - 25}}{4} \approx 6.89.$$

Therefore,  $y_h(t) = e^{-1.25t} (c_1 \cos \beta t + c_2 \sin \beta t)$ . The steady-state solution has the form

$$y_p(t) = A \cos t + B \sin t.$$

Substituting  $y_p(t)$  into (4.12) and collecting similar terms yields

$$\begin{aligned} 2y_p'' + 5y_p' + 10gy_p &= [(10g - 2)A + 5B] \cos t + [-5A + (10g - 2)B] \sin t = 0.3 \cos t \\ \Rightarrow \quad (10g - 2)A + 5B &= 0.3 \\ -5A + (10g - 2)B &= 0. \end{aligned}$$

Solving for  $A$  and  $B$ , we obtain

$$\begin{aligned} A &= \frac{0.3(10g - 2)}{(10g - 2)^2 + 25} \approx 0.00311, \\ B &= \frac{1.5}{(10g - 2)^2 + 25} \approx 0.00016. \end{aligned}$$

Thus, a general solution is given by

$$\begin{aligned} y(t) &= e^{-1.25t} (c_1 \cos \beta t + c_2 \sin \beta t) + A \cos t + B \sin t \\ &\approx e^{-1.25t} (c_1 \cos \beta t + c_2 \sin \beta t) + 0.00311 \cos t + 0.00016 \sin t. \end{aligned}$$

We now find constants  $c_1$  and  $c_2$  such that  $y(t)$  satisfies the initial conditions.

$$\begin{aligned} 0.05 &= y(0) = c_1 + A \\ 0 &= y'(0) = -1.25c_1 + \beta c_2 + B \\ \Rightarrow \quad c_1 &= 0.05 - A \approx 0.04689, \quad c_2 = \frac{1.25c_1 - B}{\beta} \approx 0.00848. \end{aligned}$$

Hence,

$$y(t) \approx e^{-1.25t} (0.04689 \cos \beta t + 0.00848 \sin \beta t) + 0.00311 \cos t + 0.00016 \sin t.$$

To find the resonance frequency, we use the formula (15) in the text.

$$\frac{1}{2\pi} \gamma_r = \frac{1}{2\pi} \sqrt{\frac{k}{m} - \frac{b^2}{2m^2}} = \frac{1}{2\pi} \sqrt{5g - \frac{25}{8}} \approx 1.0786 \text{ (sec}^{-1}\text{)}.$$

14. In the equation, governing this motion,  $my'' + by' + ky = F_{\text{ext}}$ , we have  $m = 8$ ,  $b = 3$ ,  $k = 40$ , and  $F_{\text{ext}}(t) = 2 \sin(2t + \pi/4)$ . Thus, the equation becomes

$$8y'' + 3y' + 40y = 2 \sin(2t + \pi/4) = \sqrt{2} (\sin 2t + \cos 2t).$$

Clearly, this is an underdamped motion, and the steady-state solution has the form

$$\begin{aligned} y_p(t) &= A \sin 2t + B \cos 2t \\ \Rightarrow \quad y'_p(t) &= 2A \cos 2t - 2B \sin 2t \\ \Rightarrow \quad y''_p(t) &= -4A \sin 2t - 4B \cos 2t. \end{aligned}$$

Substituting these formulas into the equation and collecting similar terms yields

$$\begin{aligned} (8A - 6B) \sin 2t + (6A + 8B) \cos 2t &= \sqrt{2} (\sin 2t + \cos 2t) \\ \Rightarrow \quad 8A - 6B &= \sqrt{2}, \\ \quad 6A + 8B &= \sqrt{2}. \end{aligned}$$

Solving this system, we get  $A = 7\sqrt{2}/50$ ,  $B = \sqrt{2}/50$ . So, the steady-state solution is

$$y(t) = \frac{7\sqrt{2}}{50} \sin 2t + \frac{\sqrt{2}}{50} \cos 2t.$$



## Chapter 4

This function has the amplitude

$$\sqrt{A^2 + B^2} = \sqrt{\left(\frac{7\sqrt{2}}{50}\right)^2 + \left(\frac{\sqrt{2}}{50}\right)^2} = \frac{1}{5} \text{ (m)}$$

and the frequency  $2/(2\pi) = 1/\pi$  ( $\text{sec}^{-1}$ ).

### REVIEW PROBLEMS

2.  $c_1e^{-t/7} + c_2te^{-t/7}$
4.  $c_1e^{5t/3} + c_2te^{5t/3}$
6.  $c_1e^{(-4+\sqrt{30})t} + c_2e^{(-4-\sqrt{30})t}$
8.  $c_1e^{-2t/5} + c_2te^{-2t/5}$
10.  $c_1 \cos(\sqrt{11}t) + c_2 \sin(\sqrt{11}t)$
12.  $c_1e^{-5t/2} + c_2e^{2t} + c_3te^{2t}$
14.  $c_1e^{2t} \cos(\sqrt{3}t) + c_2e^{2t} \sin(\sqrt{3}t)$
16.  $e^{-t} [c_1 + c_2 \cos(\sqrt{2}t) + c_3 \sin(\sqrt{2}t)]$
18.  $c_1t^3 + c_2t^2 + c_3t + c_4 + t^5$
20.  $c_1e^{t/\sqrt{2}} + c_2e^{-t/\sqrt{2}} - \left(\frac{4}{9}\right) \cos t - \left(\frac{1}{3}\right) t \sin t$
22.  $c_1e^{11t} + c_2e^{-3t} + \left(\frac{1092}{305}\right) \cos t - \left(\frac{4641}{305}\right) \sin t$
24.  $c_1e^{t/2} + c_2e^{-3t/5} - \left(\frac{1}{3}\right) t - \left(\frac{1}{9}\right) - \left(\frac{1}{11}\right) te^{t/2}$
26.  $c_1e^{-3t} \cos(\sqrt{6}t) + c_2e^{-3t} \sin(\sqrt{6}t) + \left(\frac{1}{31}\right) e^{2t} + 5$
28.  $c_1x^3 \cos(2 \ln x) + c_2x^3 \sin(2 \ln x)$
30.  $3e^{-\theta} + 2\theta e^{-\theta} + \sin \theta$
32.  $e^{t/2} \cos t - 6e^{t/2} \sin t$

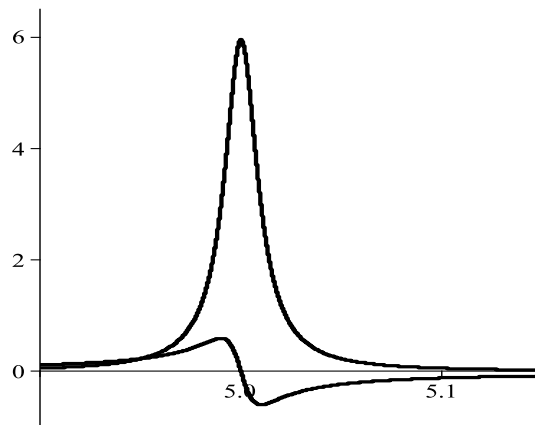
34.  $e^{-7t} + 4e^{2t}$

36.  $-3e^{-2t/3} + te^{-2t/3}$

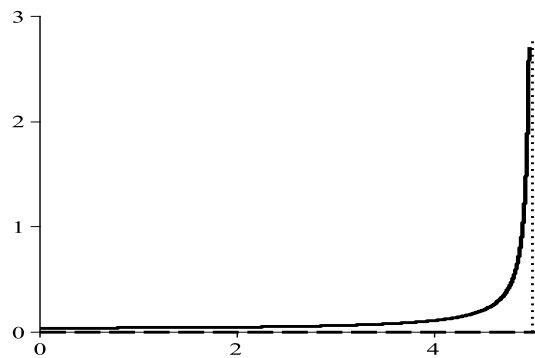
38.  $y(t) = \left(-\frac{1}{4}\right) \cos 5t + \left(\frac{1}{5}\right) \sin 5t$ , amplitude  $\approx 0.320$  m, period  $= \frac{2\pi}{5}$ , frequency  $= \frac{5}{2\pi}$

$t_{\text{equilib}} = \left(\frac{1}{5}\right) \arctan\left(\frac{5}{4}\right) \approx 0.179$  sec.

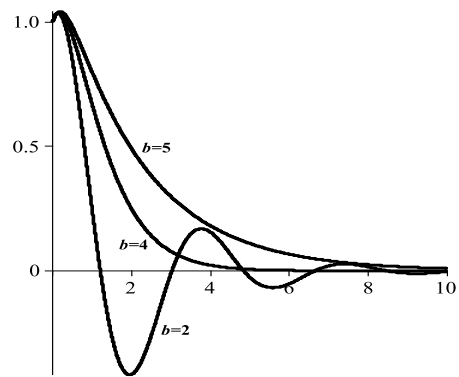
**FIGURES**



**Figure 4–A:** The graphs of  $A(\Omega)$  and  $B(\Omega)$  in Problem 10(b).

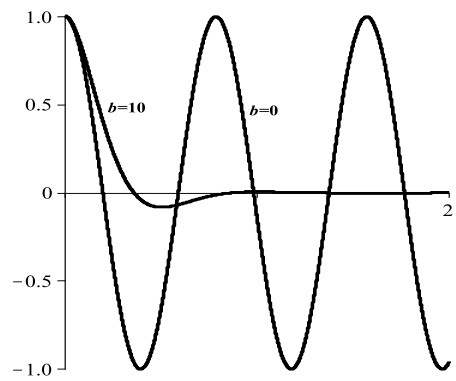


**Figure 4–B:** The graphs of  $A(\Omega)$  and  $B(\Omega)$  Problem 10(c).



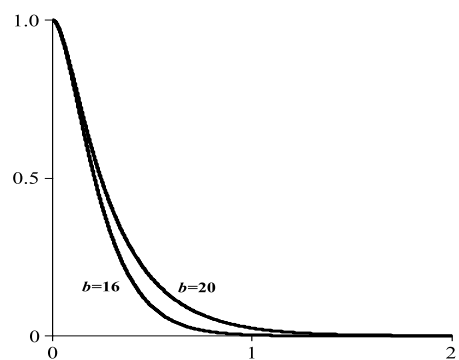
**Figure 4–C:** The graphs of solutions in Problem 28 for  $b = 5, 4,$  and  $2$ .

---



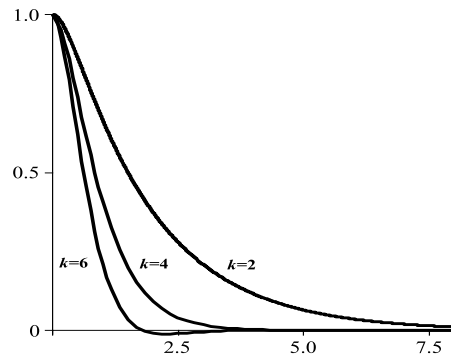
**Figure 4–D:** The graphs of the solutions in Problem 4 for  $b = 0, 10$ .

---



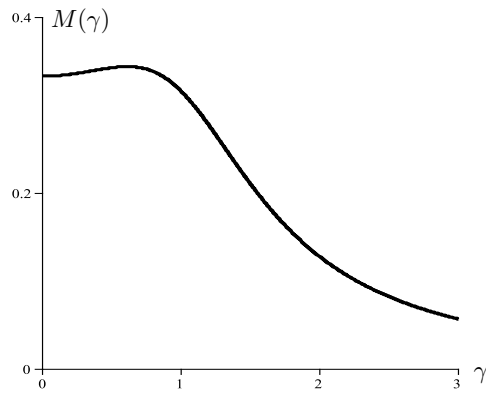
**Figure 4–E:** The graphs of the solutions in Problem 4 for  $b = 16, 20$ .

---



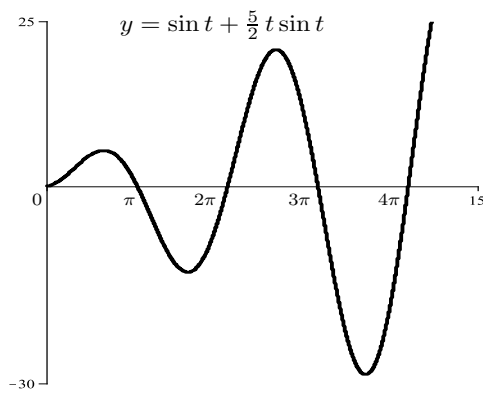
**Figure 4–F:** The graphs of the solutions in Problem 6 for  $k = 2, 4,$  and  $6$ .

---



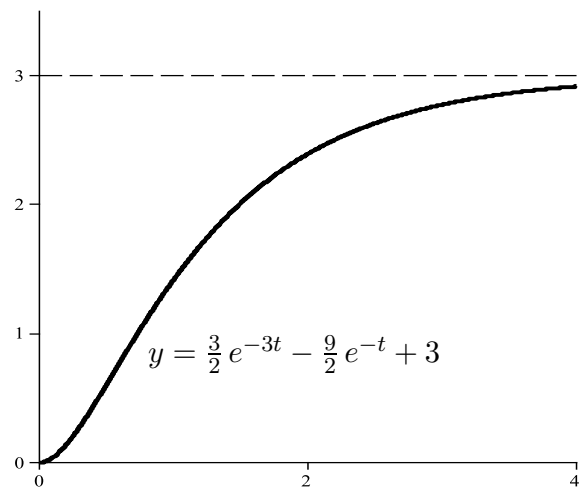
**Figure 4–G:** The frequency response curve in Problem 2.

---



**Figure 4–H:** The solution curve in Problem 4.

---



**Figure 4–I:** The solution curve in Problem 8.

---

## CHAPTER 5: Introduction to Systems and Phase Plane Analysis

### EXERCISES 5.2: Elimination Method for Systems with Constant Coefficients

2.  $x = \left(\frac{3}{2}\right) c_1 e^{2t} - c_2 e^{-3t};$

$$y = c_1 e^{2t} + c_2 e^{-3t}$$

4.  $x = -\left(\frac{1}{2}\right) c_1 e^{3t} + \left(\frac{1}{2}\right) c_2 e^{-t};$

$$y = c_1 e^{3t} + c_2 e^{-t}$$

6.  $x = \left(\frac{c_1 + c_2}{2}\right) e^t \cos 2t + \left(\frac{c_2 - c_1}{2}\right) e^t \sin 2t + \left(\frac{7}{10}\right) \cos t - \left(\frac{1}{10}\right) \sin t;$

$$y = c_1 e^t \cos 2t + c_2 e^t \sin 2t + \left(\frac{11}{10}\right) \cos t + \left(\frac{7}{10}\right) \sin t$$

8.  $x = -\left(\frac{5c_1}{4}\right) e^{11t} - \left(\frac{4}{11}\right) t - \left(\frac{26}{121}\right);$

$$y = c_1 e^{11t} + \left(\frac{1}{11}\right) t + \left(\frac{45}{121}\right)$$

10.  $x = c_1 \cos t + c_2 \sin t;$

$$y = \left(\frac{c_2 - 3c_1}{2}\right) \cos t - \left(\frac{c_1 + 3c_2}{2}\right) \sin t + \left(\frac{1}{2}\right) e^t - \left(\frac{1}{2}\right) e^{-t}$$

12.  $u = c_1 e^{2t} + c_2 e^{-2t} + 1;$

$$v = -2c_1 e^{2t} + 2c_2 e^{-2t} + 2t + c_3$$

14.  $x = -c_1 \sin t + c_2 \cos t + 2t - 1;$

$$y = c_1 \cos t + c_2 \sin t + t^2 - 2$$

16.  $x = c_1 e^t + c_2 e^{-2t} + \left(\frac{2}{9}\right) e^{4t};$

$$y = -2c_1 e^t - \left(\frac{1}{2}\right) c_2 e^{-2t} + c_3 - \left(\frac{1}{36}\right) e^{4t}$$

## Chapter 5

18.  $x(t) = -t^2 - 4t - 3 + c_3 + c_4e^t - c_1te^t - \left(\frac{1}{2}\right)c_2e^{-t};$

$$y(t) = -t^2 - 2t - c_1e^t + c_2e^{-t} + c_3$$

20.  $x(t) = \left(\frac{3}{2}\right)e^t - \left(\frac{1}{2}\right)e^{3t};$

$$y(t) = -\left(\frac{3}{2}\right)e^t - \left(\frac{1}{2}\right)e^{3t} + e^{2t}$$

22.  $x(t) = 1 + \left(\frac{9}{4}\right)e^{3t} - \frac{5}{4}e^{-t};$

$$y(t) = 1 + \left(\frac{3}{2}\right)e^{3t} - \left(\frac{5}{2}\right)e^{-t}$$

24. No solution

26.  $x = \left(\frac{1}{2}\right)e^t [(c_1 - c_2) \cos t + (c_1 + c_2) \sin t] + c_3e^{2t};$

$$y = e^t(c_1 \cos t + c_2 \sin t);$$

$$z = \left(\frac{3}{2}\right)e^t [(c_1 - c_2) \cos t + (c_1 + c_2) \sin t] + c_3e^{2t}$$

28.  $x(t) = c_1 + c_2e^{-4t} + 2c_3e^{3t};$

$$y(t) = 6c_1 - 2c_2e^{-4t} + 3c_3e^{3t};$$

$$z(t) = -13c_1 - c_2e^{-4t} - 2c_3e^{3t}$$

30.  $\lambda \leq 1$

32.  $x = \left(\frac{20 - 10\sqrt{19}}{\sqrt{19}}\right)e^{(-7+\sqrt{19})t/100} + \left(\frac{-20 - 10\sqrt{19}}{\sqrt{19}}\right)e^{(-7-\sqrt{19})t/100} + 20;$

$$y = \left(\frac{-50}{\sqrt{19}}\right)e^{(-7+\sqrt{19})t/100} + \left(\frac{50}{\sqrt{19}}\right)e^{(-7-\sqrt{19})t/100} + 20$$

34. (b)  $V_1 = \left(\frac{3}{2}c_2 - \frac{1}{2}c_1\right)e^{-t} \cos 3t - \left(\frac{1}{2}c_2 + \frac{3}{2}c_1\right)e^{-t} \sin 3t + 5L;$

$$V_2 = c_1e^{-t} \cos 3t + c_2e^{-t} \sin 3t + 18L$$

(c) As  $t \rightarrow +\infty$ ,  $V_1 \rightarrow 5L$  and  $V_2 \rightarrow 18L$

36.  $\frac{400}{11} \approx 36.4^\circ\text{F}$

38. A runaway arms race

40. (a)  $3x^2 = x^3$   
 (b)  $6x + 3x^2 - 2x^3$   
 (c)  $3x^2 + 2x^3$ ;  
 (d)  $6x + 3x^2 - 2x^3$   
 (e)  $D^2 + D - 2$ ;  
 (f)  $6x + 3x^2 - 2x^3$

**EXERCISES 5.3: Solving Systems and Higher-Order Equations Numerically**

2.  $x'_1 = x_2$ ,  
 $x'_2 = x_1^2 + \cos(t - x_1)$ ;  
 $x_1(0) = 1, x_2(0) = 0$
4.  $x'_1 = x_2$ ,  
 $x'_2 = x_3$ ,  
 $x'_3 = x_4$ ,  
 $x'_4 = x_5$ ,  
 $x'_5 = x_6$ ,  
 $x'_6 = x_2^2 - \sin x_1 + e^{2t}$ ;  
 $x_1(0) = \dots = x_6(0) = 0$
6. Setting  $x_1 = x, x_2 = x', x_3 = y, x_4 = y'$ , we obtain  
 $x'_1 = x_2$ ,  
 $x'_2 = -\left(\frac{5}{3}\right)x_1 + \left(\frac{2}{3}\right)x_3$ ,  
 $x'_3 = x_4$ ,  
 $x'_4 = \left(\frac{3}{2}\right)x_1 - \left(\frac{1}{2}\right)x_3$
8.  $x_1(0) = a; x_2(0) = p(0)b$
10. See Table 5-A on page 185
12. See Table 5-B on page 185



## Chapter 5

14.  $y(8) \approx 24.01531$

16.  $x(1) \approx 127.773$ ;  $y(1) \approx -423.476$

18. Conventional troops

20. (a) period  $\approx 2(3.14)$

(b) period  $\approx 2(3.20)$

(c) period  $\approx 2(3.34)$

24. Yes; Yes

26.  $x(1) \approx 0.80300$ ;  $y(1) \approx 0.59598$ ;  $z(1) \approx 0.82316$

28. (a)  $x'_1 = x_2$ ,  $x_1(0) = 1$

$$x'_2 = \frac{-x_1}{(x_1^2 + x_3^2)^{3/2}}, \quad x_2(0) = 0$$

$$x'_3 = x_4, \quad x_3(0) = 0$$

$$x'_4 = \frac{-x_3}{(x_1^2 + x_3^2)^{3/2}}, \quad x_4(0) = 1$$

(b) See Table **5-C** on page 185

30. (a) See Table **5-D** on page 186

(b) See Table **5-E** on page 186

### EXERCISES 5.4: Introduction to the Phase Plane

2. See Fig. **5-A** on page 187

4.  $x = -6$ ;  $y = 1$

6. The line  $y = 2$  and the point  $(1, 1)$

8.  $x^3 - x^2y - y^{-2} = c$

10. Critical points are  $(1, 0)$  and  $(-1, 0)$ . Integral curves:

$$\text{for } y > 0, |x| > 1, y = c\sqrt{x^2 - 1};$$

$$\text{for } y > 0, |x| < 1, y = c\sqrt{1 - x^2};$$

for  $y < 0$ ,  $|x| > 1$ ,  $y = -c\sqrt{x^2 - 1}$ ;

for  $y < 0$ ,  $|x| < 1$ ,  $y = -c\sqrt{1 - x^2}$ ; all with  $c \geq 0$

If  $c = 1$ ,  $y = \pm\sqrt{1 - x^2}$  are semicircles ending at  $(1, 0)$  and  $(-1, 0)$

12.  $9x^2 + 4y^2 = c$ . See Fig. 5-B on page 187

14.  $y = cx^{2/3}$  See Fig. 5-C on page 187

16.  $(0, 0)$  is a stable node. See Fig. 5-D on page 188

18.  $(0, 0)$  is an unstable node;

$(0, 5)$  is a stable node;

$(7, 0)$  is a stable node;

$(3, 2)$  is a saddle point;

See Fig. 5-E on page 188

$$20. \begin{cases} y' = v \\ v' = -y \end{cases}$$

$(0, 0)$  is a center. See Fig. 5-F on page 189

$$22. \begin{cases} y' = v \\ v' = -y^3 \end{cases}$$

$(0, 0)$  is a center. See Fig. 5-G on page 189

$$24. \begin{cases} y' = v \\ v' = -y + y^3 \end{cases}$$

$(0, 0)$  is a center;  $(-1, 0)$  is a saddle point;  $(1, 0)$  is a saddle point. See Fig. 5-H on page 190

26.  $\frac{x^2}{2} + \frac{x^4}{4} + \frac{y^2}{2} = c$ ; all solutions are bounded. See Fig. 5-I on page 190

28.  $(0, 0)$  is a center;  $(1, 0)$  is a saddle point

30. (a)  $x \rightarrow x^*$ ,  $y \rightarrow y^*$ ,  $f$  and  $g$  are continuous implies  $x'(t) \equiv f(x(t), y(t)) \rightarrow f(x^*, y^*)$   
and  $y'(t) \equiv g(x(t), y(t)) \rightarrow g(x^*, y^*)$

$$(b) x(t) = \int_T^t x'(\tau) d\tau + t(T) > \frac{f(x^*, y^*)}{2}(t - T) + x(T) \equiv f(x^*, y^*) \frac{t}{2} + C$$

## Chapter 5

- (c) If  $f(x^*, y^*) > 0$ ,  $f(x^*, y^*)t \rightarrow \infty$  implying  $x(t) \rightarrow \infty$
- (d) Similar
- (e) Similar
32.  $\frac{(y')^2}{2} + \frac{y^4}{4} = c$  by Problem 30. Thus,  $\frac{y^4}{4} = c - \frac{(y')^2}{2} \leq c$ , so  $|y| \leq \sqrt[4]{4c}$
34. See Fig. 5–J on page 191
36. (a)  $\frac{d}{dt} [x^2 + y^2 + z^2] = 0$ ; the magnitude of the angular velocity is constant
- (b) All points on the axes are critical points:  $(x, 0, 0)$ ,  $(0, y, 0)$ ,  $(0, 0, z)$
- (c) From (a),  $x^2 + y^2 + z^2 = K$  (sphere). Also  $\frac{dy}{dx} = \frac{-2x}{y}$ , so  $x^2 + \frac{y^2}{2} = c$  (cylinder)
- (d) The solutions are periodic
- (e) The critical point on the  $y$ -axis is unstable. The other two are stable

### EXERCISES 5.5: Applications to Biomathematics: Epidemic and Tumor Growth Models

2.  $79.95mCi$

### EXERCISES 5.6: Coupled Mass–Spring Systems

2.  $x(t) = \left(\frac{\sqrt{10}}{20}\right) [(1 - \sqrt{10}) \cos r_1 t - (1 + \sqrt{10}) \cos r_2 t]$ ;  
 $y(t) = \left(\frac{3\sqrt{10}}{20}\right) (\cos r_1 t - \cos r_2 t)$ , where  $r_1 = \sqrt{4 + \sqrt{10}}$  and  $r_2 = \sqrt{4 - \sqrt{10}}$
4.  $m_1 x'' = -k_1 x + k_2 (y - x)$ ;  
 $m_2 y'' = -k_2 (y - x) - by'$
6. (b)  $x(t) = c_1 \cos t + c_2 \sin t + c_3 \cos 2t + c_4 \sin 2t + \left(\frac{37}{40}\right) \cos 3t$
- (c)  $y(t) = 2c_1 \cos t + 2c_2 \sin t - c_3 \cos 2t - c_4 \sin 2t - \left(\frac{111}{20}\right) \cos 3t$
- (d)  $x(t) = \left(\frac{23}{8}\right) \cos t - \left(\frac{9}{5}\right) \cos 2t + \left(\frac{37}{40}\right) \cos 3t$ ;  
 $y(t) = \left(\frac{23}{4}\right) \cos t + \left(\frac{9}{5}\right) \cos 2t - \left(\frac{111}{20}\right) \cos 3t$

$$8. \theta_1(t) = \frac{\pi}{12} \cos\left(\sqrt{\frac{9.8}{5 + \sqrt{10}}}t\right) + \frac{\pi}{12} \cos\left(\sqrt{\frac{9.8}{5 - \sqrt{10}}}t\right);$$

$$\theta_2(t) = \frac{\pi\sqrt{10}}{24} \cos\left(\sqrt{\frac{9.8}{5 + \sqrt{10}}}t\right) - \frac{\pi\sqrt{10}}{24} \cos\left(\sqrt{\frac{9.8}{5 - \sqrt{10}}}t\right)$$

**EXERCISES 5.7: Electrical Systems**

$$2. q(t) = \left(\frac{1}{2}\right) e^{-4t} \cos 6t + 3 \cos 2t + \sin 2t \text{ coulombs}$$

$$4. I(t) = \left(\frac{10}{33}\right) \cos 5t - \left(\frac{10}{33}\right) \cos 50t \text{ amps}$$

$$8. L = 0.01 \text{ henrys, } R = 0.2 \text{ ohms, } C = \frac{25}{32} \text{ farads, and } E(t) = \left(\frac{2}{5}\right) \cos 8t \text{ volts}$$

$$10. I_1 = -\left(\frac{1}{4}\right) e^{-2t} - \left(\frac{9}{4}\right) e^{-2t/3} + \frac{5}{2};$$

$$I_2 = \left(\frac{1}{4}\right) e^{-2t} - \left(\frac{3}{4}\right) e^{-2t/3} + \frac{1}{2};$$

$$I_3 = -\left(\frac{1}{2}\right) e^{-2t} - \left(\frac{3}{2}\right) e^{-2t/3} + 2$$

$$12. I_1 = 1 - e^{-900t}; I_2 = \left(\frac{5}{9}\right) - \left(\frac{5}{9}\right) e^{-900t}; I_3 = \left(\frac{4}{9}\right) - \left(\frac{4}{9}\right) e^{-900t}$$

**EXERCISES 5.8: Dynamical Systems, Poincaré Maps, and Chaos**

$$2. (x_0, v_0) = (-1.5, 0.5774)$$

$$(x_1, v_1) = (-1.9671, -0.5105)$$

$$(x_2, v_2) = (-0.6740, 0.3254)$$

$$\vdots$$

$$(x_{20}, v_{20}) = (-1.7911, -0.5524)$$

The limit set is the ellipse  $(x + 1.5)^2 + 3v^2 = 1$

$$4. (x_0, v_0) = (0, 10.9987)$$

$$(x_1, v_1) = (-0.00574, 10.7298)$$

$$(x_2, v_2) = (-0.00838, 10.5332)$$

## Chapter 5

⋮

$$(x_{20}, v_{20}) = (-0.00029, 10.0019)$$

The attractor is the point  $(0, 10)$

- 12.** For  $F = 0.2$ , the attractor is the point  $(-0.319, -0.335)$ . For  $F = 0.28$ , the attractor is the point  $(-0.783, 0.026)$
- 14.** The attractor consists of two points:  $(-1.51, 0.06)$  and  $(-0.22, -0.99)$ . See Fig. **5–K** on page 191

### REVIEW PROBLEMS

- 2.**  $x = -(c_1 + c_2)e^{-t} \cos 2t + (c_1 - c_2)e^{-t} \sin 2t$ ;  
 $y = 2c_1e^{-t} \cos 2t + 2c_2e^{-t} \sin 2t$
- 4.**  $x = c_1t + c_2 + e^{-t}$ ;  $y = \left(\frac{1}{6}\right)c_1t^3 + \left(\frac{1}{2}\right)c_2t^2 + c_3t + c_4$
- 6.**  $x = e^{2t} + e^{-t}$ ;  $y = e^{2t} + e^{-t}$ ;  $z = e^{2t} - 2e^{-t}$
- 8.** With  $x_1 = y$ ,  $x_2 = y'$ , we obtain  $x'_1 = x_2$ ,  $x'_2 = \frac{1}{2}(\sin t - 8x_1 + tx_2)$
- 10.** With  $x_1 = x$ ,  $x_2 = x'$ ,  $x_3 = y$ ,  $x_4 = y'$ , we get  $x'_1 = x_2$ ,  $x'_2 = x_1 - x_3$ ,  $x'_3 = x_4$ ,  $x'_4 = -x_2 + x_3$
- 12.** Solutions to the phase plane equation  $\frac{dy}{dx} = \frac{2-x}{y-2}$  are given implicitly by the equation  $(x-2)^2 + (y-2)^2 = \text{const.}$  Critical point is at  $(2, 2)$ , which is a stable center. See Fig. **5–L** on page 192
- 14.** Critical points are  $(m\pi, n\pi)$  ( $m, n$  integers) and  $\left(\frac{(2j+1)\pi}{2}, \frac{(2k+1)\pi}{2}\right)$  ( $j, k$  integers).  
 Equation for integral curves is  $\frac{dy}{dx} = \frac{\cos x \sin y}{\sin x \cos y} = \frac{\tan y}{\tan x}$ , with solutions  $\sin y = C \sin x$
- 16.** Origin is a saddle(unstable) See Fig. **5–M** on page 192
- 18.** Natural angular frequencies are  $\sqrt{2}, 2\sqrt{3}$ .  
 General solution is  $x(t) = c_1 \cos(2\sqrt{3}t) + c_2 \sin(2\sqrt{3}t) + c_3 \cos(\sqrt{2}t) + c_4 \sin(\sqrt{2}t)$ ;  
 $y(t) = -\left(\frac{1}{3}\right)c_1 \cos(2\sqrt{3}t) - \left(\frac{1}{3}\right)c_2 \sin(2\sqrt{3}t) + 3c_3 \cos(\sqrt{2}t) + 3c_4 \sin(\sqrt{2}t)$

## TABLES

$i$	$t_i$	$y(t_i)$
1	0.250	0.96924
2	0.500	0.88251
3	0.750	0.75486
4	1.000	0.60656

**Table 5–A:** Approximations to the solution in Problem 10.

---

$i$	$t_i$	$y(t_i)$
1	1.250	0.80761
2	1.500	0.71351
3	1.750	0.69724
4	2.000	0.74357

**Table 5–B:** Approximations to the solution in Problem 12.

---

$i$	$t_i$	$x_1(t_i) \approx x(t_i)$	$x_3(t_i) \approx y(t_i)$
10	0.628	0.80902	0.58778
20	1.257	0.30902	0.95106
30	1.885	-0.30902	0.95106
40	2.513	0.80902	0.58779
50	3.142	-1.00000	0.00000
60	3.770	-0.80902	-0.58778
70	4.398	-0.30903	-0.95106
80	5.027	0.30901	-0.95106
90	5.655	0.80901	-0.58780
100	6.283	1.00000	-0.00001

**Table 5–C:** Approximations to the solution in Problem 28.

---

$t_i$	$l_i$	$\theta_i$
1.0	5.27015	0.0
2.0	4.79193	0.0
3.0	4.50500	0.0
4.0	4.67318	0.0
5.0	5.14183	0.0
6.0	5.48008	0.0
7.0	5.37695	0.0
8.0	4.92725	0.0
9.0	4.54444	0.0
10.0	4.58046	0.0

**Table 5–D:** Approximations to the solution in Problem 30(a).

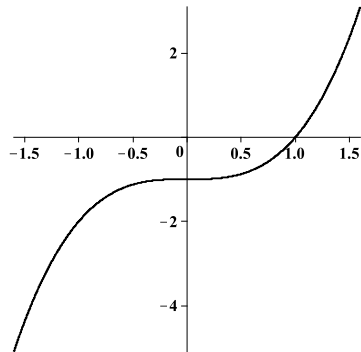
---

$t_i$	$l_i$	$\theta_i$
1.0	5.13916	0.45454
2.0	4.10579	0.28930
3.0	2.89358	-0.10506
4.0	2.11863	-0.83585
5.0	2.13296	-1.51111
6.0	3.18065	-1.64163
7.0	5.10863	-1.49843
8.0	6.94525	-1.29488
9.0	7.76451	-1.04062
10.0	7.68681	-0.69607

**Table 5–E:** Approximations to the solution in Problem 30(b).

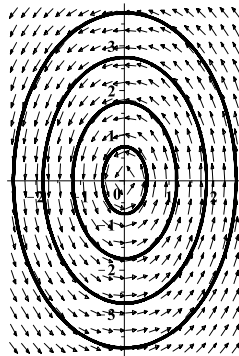
---

**FIGURES**



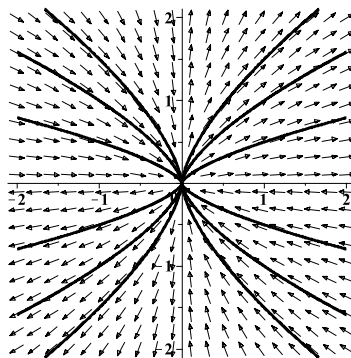
**Figure 5–A:** Problem 2, Section 5.4

---



**Figure 5–B:** Problem 12, Section 5.4

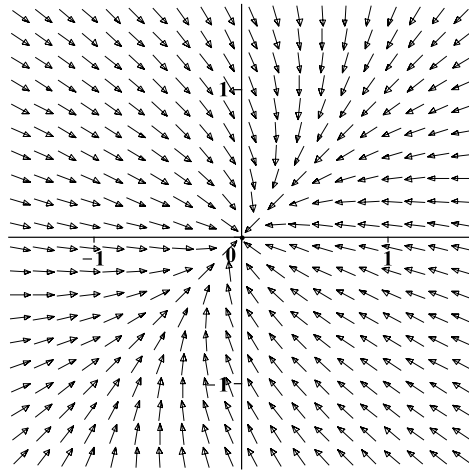
---



**Figure 5–C:** Problem 14, Section 5.4

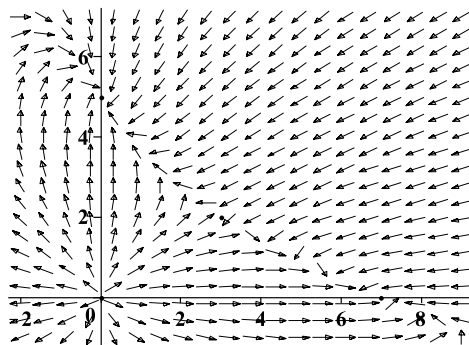
---





**Figure 5–D:** Problem 16, Section 5.4

---



**Figure 5–E:** Problem 18, Section 5.4

---

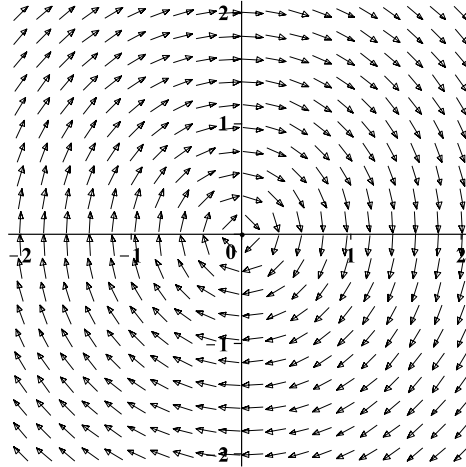


Figure 5–F: Problem 20, Section 5.4

---

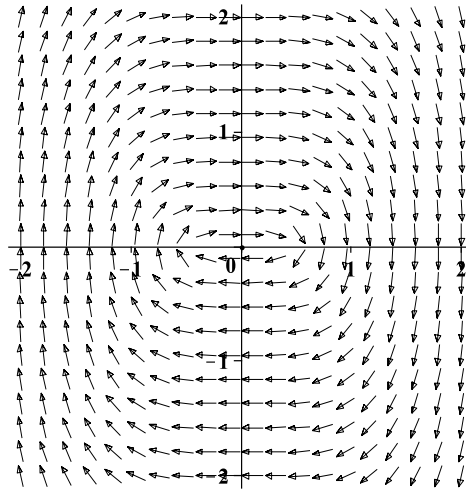


Figure 5–G: Problem 22, Section 5.4

---

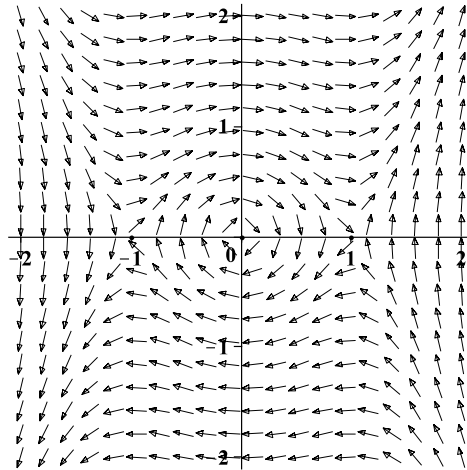


Figure 5–H: Problem 24, Section 5.4

---

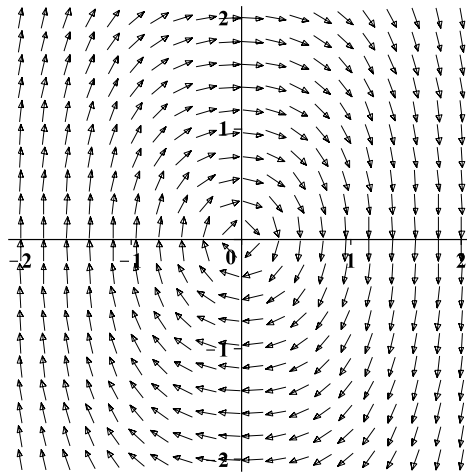


Figure 5–I: Problem 26, Section 5.4

---

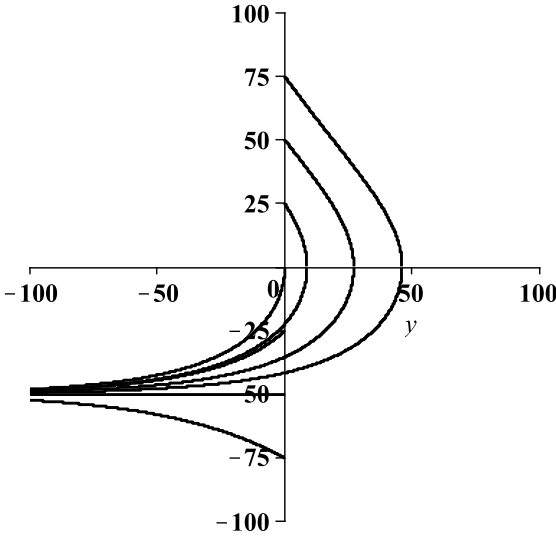


Figure 5–J: Problem 34, Section 5.4

---

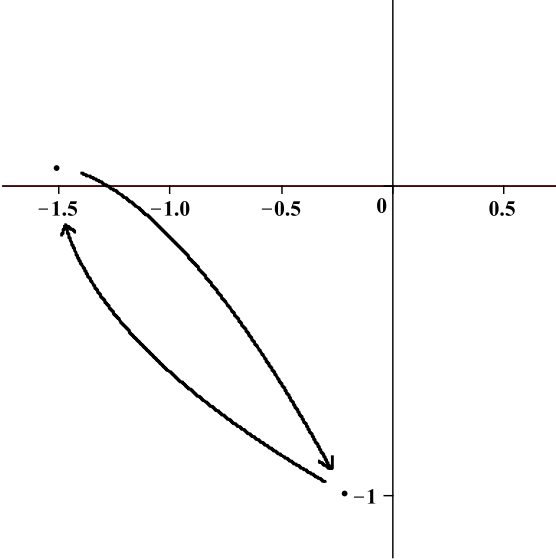


Figure 5–K: Problem 14, Section 5.8

---

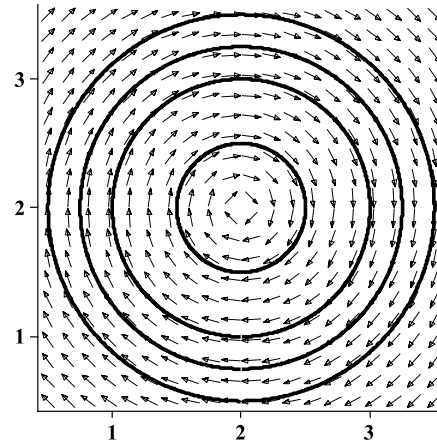


Figure 5–L: Problem 12, Review Problems

---

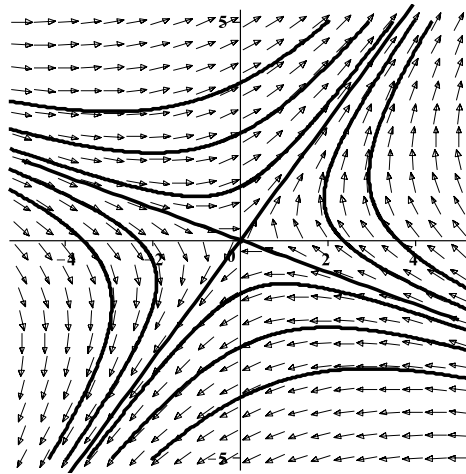


Figure 5–M: Problem 16, Review Problems

---

## CHAPTER 6: Theory of Higher-Order Linear Differential Equations

### EXERCISES 6.1: Basic Theory of Linear Differential Equations

2.  $(0, \infty)$
4.  $(-1, 0)$
6.  $(0, 1)$
8. Linearly dependent; 0
10. Linearly independent;  $-2 \tan^3 x - \sin x \cos x - \sin^2 x \tan x - 2 \tan x$
12. Linearly dependent; 0
14. Linearly independent;  $(x + 2)e^x$
16.  $c_1 e^x + c_2 \cos 2x + c_3 \sin 2x$
18.  $c_1 e^x + c_2 e^{-x} + c_3 \cos x + c_4 \sin x$
20. (a)  $c_1 + c_2 x + c_3 x^3 + x^2$   
(b)  $2 - x^3 + x^2$
22. (a)  $c_1 e^x \cos x + c_2 e^x \sin x + c_3 e^{-x} \cos x + c_4 e^{-x} \sin x + \cos x$   
(b)  $e^x \cos x + \cos x$
24. (a)  $7 \cos 2x + 1$   
(b)  $-6 \cos 2x - (11/3)$
26.  $y(x) = \sum_{j=1}^{n+1} \gamma_{j-1} y_j(x)$
34. The coefficient is the Wronskian  $W[f_1, f_2, f_3](x)$

## Chapter 6

### EXERCISES 6.2: Homogeneous Linear Equations with Constant Coefficients

2.  $c_1e^x + c_2e^{-x} + c_3e^{3x}$
4.  $c_1e^{-x} + c_2e^{-5x} + c_3e^{4x}$
6.  $c_1e^{-x} + c_2e^x \cos x + c_3e^x \sin x$
8.  $c_1e^x + c_2xe^x + c_3e^{-7x}$
10.  $c_1e^{-x} + c_2e^{(-1+\sqrt{7})x} + c_3e^{(-1-\sqrt{7})x}$
12.  $c_1e^x + c_2e^{-3x} + c_3xe^{-3x}$
14.  $c_1 \sin x + c_2 \cos x + c_3e^{-x} + c_4xe^{-x}$
16.  $(c_1 + c_2x)e^{-x} + (c_3 + c_4x + c_5x^2)e^{6x} + c_6e^{-5x} + c_7 \cos x + c_8 \sin x + c_9 \cos 2x + c_{10} \sin 2x$
18.  $(c_1 + c_2x + c_3x^2)e^x + c_4e^{2x} + c_5e^{-x/2} \cos(\sqrt{3}x/2) + c_6e^{-x/2} \sin(\sqrt{3}x/2)$   
 $+ (c_7 + c_8x + c_9x^2)e^{-3x} \cos x + (c_{10} + c_{11}x + c_{12}x^2)e^{-3x} \sin x$
20.  $e^{-x} - e^{-2x} + e^{-4x}$
22.  $x(t) = c_1e^{\sqrt{3}t} + c_2e^{-\sqrt{3}t} + c_3 \cos 2t + c_4 \sin 2t,$   
 $y(t) = -(2c_1/5)e^{\sqrt{3}t} - (2c_2/5)e^{-\sqrt{3}t} + c_3 \cos 2t + c_4 \sin 2t$
28.  $c_1e^{1.879x} + c_2e^{-1.532x} + c_3e^{-0.347x}$
34.  $x(t) = \left(\frac{5 - \sqrt{10}}{10}\right) \cos \sqrt{4 + \sqrt{10}}t + \left(\frac{5 + \sqrt{10}}{10}\right) \cos \sqrt{4 - \sqrt{10}}t,$   
 $y(t) = \left(\frac{5 - 2\sqrt{10}}{10}\right) \cos \sqrt{4 + \sqrt{10}}t + \left(\frac{5 + 2\sqrt{10}}{10}\right) \cos \sqrt{4 - \sqrt{10}}t$

### EXERCISES 6.3: Undetermined Coefficients and the Annihilator Method

2.  $c_1e^{-x} + c_2 \cos x + c_3 \sin x$
4.  $c_1 + c_2xe^x + c_3x^2e^x$
6.  $c_1e^x + c_2xe^x + c_3e^{-3x} + (1/8)e^{-x} + (3/20) \cos x + (1/20) \sin x$
8.  $c_1e^x + c_2e^{-x} \cos x + c_3e^{-x} \sin x - (1/2) - (4/25)xe^x + (1/10)x^2e^x$

$$10. \quad c_1 e^{2x} + c_2 e^{-3x} \cos 2x + c_3 e^{-3x} \sin 2x + (5/116) x e^{-3x} \cos 2x - (1/58) x e^{-3x} \sin 2x \\ - (1/26) x - (1/676)$$

$$12. \quad D^3$$

$$14. \quad D - 5$$

$$16. \quad D^3(D - 1)$$

$$18. \quad [(D - 3)^2 + 25]^2$$

$$20. \quad D^4(D - 1)^3(D^2 + 16)^2$$

$$22. \quad c_1 e^{3x} + c_2 \cos x + c_3 \sin x$$

$$24. \quad c_1 x e^x + c_2 x^2 e^x$$

$$26. \quad c_1 x^2 + c_2 x + c_3$$

$$28. \quad c_1 e^{3x} + c_2 + c_3 x$$

$$30. \quad c_1 x e^x + c_2$$

$$32. \quad 5 + e^x \sin 2x - e^{3x}$$

$$38. \quad x(t) = \{c_1 + (1/2) + (1/4)t\} e^t - \{(3/2)c_2 + (\sqrt{7}/2)c_3\} e^{-t/2} \cos(\sqrt{7}t/2) \\ + \{(\sqrt{7}/2)c_2 - (3/2)c_3\} e^{-t/2} \sin(\sqrt{7}t/2) + t + 1, \\ y(t) = \{c_1 + (1/4)t\} e^t + c_2 e^{-t/2} \cos(\sqrt{7}t/2) + c_3 e^{-t/2} \sin(\sqrt{7}t/2) + (1/2)$$

$$40. \quad I_1(t) = (2187/40) \sin(t/8) - (3/40) \sin(t/72) - 18 \sin(t/24),$$

$$I_2(t) = (243/40) \sin(t/8) - (27/40) \sin(t/72),$$

$$I_3(t) = (243/5) \sin(t/8) + (3/5) \sin(t/72) - 18 \sin(t/24)$$

#### EXERCISES 6.4: Method of Variation of Parameters

$$2. \quad (1/2)x^2 + 2x$$

$$4. \quad (1/6)x^3 e^x$$

$$6. \quad \sec \theta - \sin \theta \tan \theta + \theta \sin \theta + (\cos \theta) \ln(\cos \theta)$$



## Chapter 6

8.  $c_1x + c_2x \ln x + c_3x^3 - x^2$

10.  $1/(10x) \int g(x)dx + (x^4/15) \int x^{-5}g(x)dx - (x/6) \int x^{-2}g(x)dx$

### REVIEW PROBLEMS

2. (a) Linearly independent.

(b) Linearly independent.

(c) Linearly dependent.

4. (a)  $c_1e^{-3x} + c_2e^{-x} + c_3e^x + c_4xe^x$

(b)  $c_1e^x + c_2e^{(-2+\sqrt{5})x} + c_3e^{(-2-\sqrt{5})x}$

(c)  $c_1e^x + c_2 \cos x + c_3 \sin x + c_4x \cos x + c_5x \sin x$

(d)  $c_1e^x + c_2e^{-x} + c_3e^{2x} - (x/2)e^x + (x/2) + (1/4)$

6.  $c_1e^{-x/\sqrt{2}} \cos(x/\sqrt{2}) + c_2e^{-x/\sqrt{2}} \sin(x/\sqrt{2})$   
 $+ c_3e^{x/\sqrt{2}} \cos(x/\sqrt{2}) + c_4e^{x/\sqrt{2}} \sin(x/\sqrt{2}) + \sin(x^2)$

8. (a)  $c_1xe^{-x} + c_2 + c_3x + c_4x^2$

(b)  $c_1xe^{-x} + c_2x^2e^{-x}$

(c)  $c_1 + c_2x + c_3x^2 + c_4 \cos 3x + c_5 \sin 3x$

(d)  $c_1 \cos x + c_2 \sin x + c_3x \cos x + c_4x \sin x$

10. (a)  $c_1x^{1/2} + c_2x^{-1/2} + c_3x$

(b)  $c_1x^{-1} + c_2x \cos(\sqrt{3} \ln x) + c_3x \sin(\sqrt{3} \ln x)$

## CHAPTER 7: Laplace Transforms

### EXERCISES 7.2: Definition of the Laplace Transform

2. For  $s > 0$ , using Definition and integration by parts twice, we compute

$$\begin{aligned}\mathcal{L}\{t^2\}(s) &= \int_0^{\infty} e^{-st} t^2 dt = \lim_{N \rightarrow \infty} \int_0^N e^{-st} t^2 dt \\ &= \lim_{N \rightarrow \infty} \left[ -\frac{t^2 e^{-st}}{s} \Big|_0^N + \frac{2}{s} \int_0^N t e^{-st} dt \right] = \lim_{N \rightarrow \infty} \left( -\frac{t^2}{s} - \frac{2t}{s^2} - \frac{2}{s^3} \right) e^{-st} \Big|_0^N \\ &= \lim_{N \rightarrow \infty} \left[ \frac{2}{s^3} - \left( \frac{N^2}{s} + \frac{2N}{s^2} + \frac{2}{s^3} \right) e^{-sN} \right] = \frac{2}{s^3},\end{aligned}$$

because, for  $s > 0$  and any  $k$ ,  $N^k e^{-sN} \rightarrow 0$  as  $N \rightarrow \infty$ .

4. For  $s > 3$ , we have

$$\begin{aligned}\mathcal{L}\{te^{3t}\}(s) &= \int_0^{\infty} e^{-st} te^{3t} dt = \int_0^{\infty} te^{(3-s)t} dt = \lim_{N \rightarrow \infty} \int_0^N te^{(3-s)t} dt \\ &= \lim_{N \rightarrow \infty} \left( \frac{t}{3-s} - \frac{1}{(3-s)^2} \right) e^{(3-s)t} \Big|_0^N \\ &= \lim_{N \rightarrow \infty} \left[ \frac{1}{(3-s)^2} + \left( \frac{N}{3-s} - \frac{1}{(3-s)^2} \right) e^{(3-s)N} \right] = \frac{1}{(s-3)^2}.\end{aligned}$$

6. Referring to the table of integrals on the inside front cover, we see that, for  $s > 0$ ,

$$\begin{aligned}\mathcal{L}\{\cos bt\}(s) &= \int_0^{\infty} e^{-st} \cos bt dt = \lim_{N \rightarrow \infty} \int_0^N e^{-st} \cos bt dt \\ &= \lim_{N \rightarrow \infty} \frac{e^{-st} (-s \cos bt + b \sin bt)}{s^2 + b^2} \Big|_0^N \\ &= \lim_{N \rightarrow \infty} \left[ \frac{e^{-sN} (-s \cos bN + b \sin bN)}{s^2 + b^2} - \frac{-s}{s^2 + b^2} \right] = \frac{s}{s^2 + b^2},\end{aligned}$$

where we have used integration by parts to find an antiderivative of  $e^{-st} \cos 2t$ .

## Chapter 7

8. For  $s > -1$ ,

$$\begin{aligned}\mathcal{L}\{e^{-t} \sin 2t\}(s) &= \int_0^{\infty} e^{-st} e^{-t} \sin 2t \, dt = \int_0^{\infty} e^{-(s+1)t} \sin 2t \, dt \\ &= \lim_{N \rightarrow \infty} \left. \frac{e^{-(s+1)t} (-(s+1) \sin 2t - 2 \cos 2t)}{(s+1)^2 + 4} \right|_0^N \\ &= \lim_{N \rightarrow \infty} \frac{e^{-(s+1)N} [-(s+1) \sin 2N - 2 \cos 2N] + 2}{(s+1)^2 + 4} = \frac{2}{(s+1)^2 + 4}.\end{aligned}$$

10. In this problem,  $f(t)$  is also a piecewise defined function. So, we split the integral and obtain

$$\begin{aligned}\mathcal{L}\{f(t)\}(s) &= \int_0^{\infty} e^{-st} f(t) \, dt = \int_0^1 e^{-st} (1-t) \, dt + \int_1^{\infty} e^{-st} \cdot 0 \, dt = \int_0^1 (1-t) e^{-st} \, dt \\ &= \left( -\frac{1-t}{s} + \frac{1}{s^2} \right) e^{-st} \Big|_0^1 = \frac{e^{-s}}{s^2} + \frac{1}{s} - \frac{1}{s^2},\end{aligned}$$

which is valid for all  $s$ .

12. Splitting the integral in the definition of Laplace transform, we get

$$\begin{aligned}\mathcal{L}\{f(t)\}(s) &= \int_0^{\infty} e^{-st} f(t) \, dt = \int_0^3 e^{-st} e^{2t} \, dt + \int_3^{\infty} e^{-st} \cdot 1 \, dt \\ &= \frac{e^{(2-s)t}}{2-s} \Big|_0^3 - \frac{e^{-st}}{s} \Big|_3^{\infty} = \frac{1 - e^{-3(s-2)}}{s-2} + \frac{e^{-3s}}{s},\end{aligned}$$

which is valid for all  $s > 2$ .

14. By the linearity of the Laplace transform,

$$\mathcal{L}\{5 - e^{2t} + 6t^2\}(s) = 5\mathcal{L}\{1\}(s) - \mathcal{L}\{e^{2t}\}(s) + 6\mathcal{L}\{t^2\}(s).$$

From Table 7.1 in the text, we see that

$$\begin{aligned}\mathcal{L}\{1\}(s) &= \frac{1}{s}, & s > 0, \\ \mathcal{L}\{e^{2t}\}(s) &= \frac{1}{s-2}, & s > 2, \\ \mathcal{L}\{t^2\}(s) &= \frac{2!}{s^2+1} = \frac{2}{s^3}, & s > 0.\end{aligned}$$

Thus, the formula

$$\mathcal{L}\{5 - e^{2t} + 6t^2\}(s) = \frac{5}{s} - \frac{1}{s-2} + \frac{12}{s^3}$$

is valid for  $s$  in the intersection of the sets  $s > 2$  and  $s > 0$ , which is  $s > 2$ .

16. Using the linearity of Laplace transform and Table 7.1 in the text, we get

$$\begin{aligned}\mathcal{L}\{t^2 - 3t - 2e^{-t} \sin 3t\}(s) &= \mathcal{L}\{t^2\}(s) - 3\mathcal{L}\{t\}(s) - 2\mathcal{L}\{e^{-t} \sin 3t\}(s) \\ &= \frac{2!}{s^{2+1}} - 3\frac{1!}{s^{1+1}} - 2\frac{3}{(s+1)^2 + 3^2} \\ &= \frac{2}{s^3} - \frac{3}{s^2} - \frac{6}{(s+1)^2 + 9},\end{aligned}$$

valid for  $s > 0$ .

18. Using the linearity of Laplace transform and Table 7.1, we get

$$\begin{aligned}\mathcal{L}\{t^4 - t^2 - t + \sin \sqrt{2}t\} &= \mathcal{L}\{t^4\} - \mathcal{L}\{t^2\} - \mathcal{L}\{t\} + \mathcal{L}\{\sin \sqrt{2}t\} \\ &= \frac{4!}{s^{4+1}} - \frac{2!}{s^{2+1}} - \frac{1!}{s^{1+1}} + \frac{\sqrt{2}}{s^2 + (\sqrt{2})^2} \\ &= \frac{24}{s^5} - \frac{2}{s^3} - \frac{1}{s^2} + \frac{\sqrt{2}}{s^2 + 2},\end{aligned}$$

valid for  $s > 0$ .

20. For  $s > -2$ , we have

$$\begin{aligned}\mathcal{L}\{e^{-2t} \cos \sqrt{3}t - t^2 e^{-2t}\}(s) &= \mathcal{L}\{e^{-2t} \cos \sqrt{3}t\}(s) - \mathcal{L}\{t^2 e^{-2t}\}(s) \\ &= \frac{s+2}{(s+2)^2 + (\sqrt{3})^2} - \frac{2!}{(s+2)^{2+1}} \\ &= \frac{s+2}{(s+2)^2 + 3} - \frac{2}{(s+2)^3}.\end{aligned}$$

22. Since the function  $g_1(t) \equiv 0$  is continuous on  $(-\infty, \infty)$  and  $f(t) = g_1(t)$  for  $t$  in  $[0, 2)$ , we conclude that  $f(t)$  is continuous on  $[0, 2)$  and continuous from the left at  $t = 2$ . The function  $g_2(t) \equiv t$  is also continuous on  $(-\infty, \infty)$ , and so  $f(t)$  (which is the same as  $g_2(t)$  on  $[2, 10]$ ) is continuous on  $(2, 10]$ . Since

$$\lim_{t \rightarrow 2^-} f(t) = 0 \neq 2 \lim_{t \rightarrow 2^+} f(t),$$

$f(t)$  has a jump discontinuity at  $t = 2$ . Thus  $f(t)$  is piecewise continuous on  $[0, 10]$ . The graph of  $f(t)$  is depicted in Fig. 7-A on page 263.

24. Given function is a rational function and, therefore, continuous on its domain, which is all reals except zeros of the denominator. Solving  $t^2 - 4 = 0$ , we conclude that the

## Chapter 7

points of discontinuity of  $f(t)$  are  $t = \pm 2$ . The point  $t = -2$  is not in  $[0, 10]$ , and

$$\lim_{t \rightarrow 2} f(t) = \lim_{t \rightarrow 2} \frac{t^2 - 3t + 2}{t^2 - 4} = \lim_{t \rightarrow 2} \frac{(t-2)(t-1)}{(t-2)(t+2)} = \lim_{t \rightarrow 2} \frac{t-1}{t+2} = \frac{1}{4}.$$

Therefore,  $f(t)$  has a removable singularity at  $t = 2$ , and it is piecewise continuous on  $[0, 10]$ . The graph of  $f(t)$  is shown in Fig. 7–B on page 263.

**26.** Since

$$\lim_{t \rightarrow 1^+} f(t) = \lim_{t \rightarrow 1^+} \frac{t}{t^2 - 1} = +\infty,$$

$f(t)$  has an infinite discontinuity at  $t = 1$ , and it is so neither continuous nor piecewise continuous  $[0, 10]$ . The graph of  $f(t)$  is depicted in Fig. 7–C on page 263.

**28.** This function is continuous everywhere except, possibly,  $t = 0$ . Using L'Hospital's rule, we see that

$$\lim_{t \rightarrow 0} f(t) = \lim_{t \rightarrow 0} \frac{\sin t}{t} = \lim_{t \rightarrow 0} \frac{\cos t}{1} = 1 = f(1).$$

Therefore,  $f(t)$  is continuous at  $t = 0$  as well, and so it is continuous on  $(-\infty, \infty)$ . The graph of  $f(t)$  is given in Fig. 7–D on page 264.

**30.** All the Laplace transforms  $F(s)$  in Table 7.1 are proper rational functions, that is, the degree of the numerator is less than the degree of the denominator. Therefore,

$$\lim_{s \rightarrow \infty} F(s) = 0.$$

**32.** This statement is a consequence of the following more general result.

*If  $\lim_{t \rightarrow \infty} f(t) = 0$  and, for some  $T$ ,  $|g(t)| \leq M$  for  $t \geq T$ , then  $\lim_{t \rightarrow \infty} f(t)g(t) = 0$ .*

Indeed, for  $t \geq T$ , one has

$$0 \leq |f(t)g(t)| \leq M|f(t)| \rightarrow 0, \quad \text{as } t \rightarrow \infty.$$

Therefore, by the squeeze theorem,

$$\lim_{t \rightarrow \infty} |f(t)g(t)| = 0 \quad \Leftrightarrow \quad \lim_{t \rightarrow \infty} f(t)g(t) = 0.$$

In the given problem, we take  $f(t) = e^{-st}$  and  $g(t) = s \sin bt + b \cos bt$ . Then  $f(t) \rightarrow 0$ , as  $t \rightarrow \infty$ , because  $s > 0$  and  $g(t)$  is bounded (by  $s + |b|$ ).

**EXERCISES 7.3: Properties of the Laplace Transform**

2. Using the linearity of the Laplace transform, we get

$$\mathcal{L}\{3t^2 - e^{2t}\}(s) = 3\mathcal{L}\{t^2\}(s) - \mathcal{L}\{e^{2t}\}(s).$$

From Table 7.1 in Section 7.2 we know that

$$\mathcal{L}\{t^2\}(s) = \frac{2!}{s^3} = \frac{2}{s^3}, \quad \mathcal{L}\{e^{2t}\}(s) = \frac{1}{s-2}.$$

Thus

$$\mathcal{L}\{3t^2 - e^{2t}\}(s) = 3\frac{2}{s^3} - \frac{1}{s-2} = \frac{6}{s^3} - \frac{1}{s-2}.$$

4. By the linearity of the Laplace transform,

$$\mathcal{L}\{3t^4 - 2t^2 + 1\}(s) = 3\mathcal{L}\{t^4\}(s) - 2\mathcal{L}\{t^2\}(s) + \mathcal{L}\{1\}(s).$$

From Table 7.1 of the text we see that

$$\mathcal{L}\{t^4\}(s) = \frac{4!}{s^5}, \quad \mathcal{L}\{t^2\}(s) = \frac{2!}{s^3}, \quad \mathcal{L}\{1\}(s) = \frac{1}{s}, \quad s > 0.$$

Therefore,

$$\mathcal{L}\{3t^4 - 2t^2 + 1\}(s) = 3\frac{4!}{s^5} - 2\frac{2!}{s^3} + \frac{1}{s} = \frac{72}{s^5} - \frac{4}{s^3} + \frac{1}{s},$$

is valid for  $s > 0$ .

6. We use the linearity of the Laplace transform and Table 7.1 to get

$$\begin{aligned} \mathcal{L}\{e^{-2t} \sin 2t + e^{3t} t^2\}(s) &= \mathcal{L}\{e^{-2t} \sin 2t\}(s) + \mathcal{L}\{e^{3t} t^2\}(s) \\ &= \frac{2}{(s+2)^2 + 4} + \frac{2}{(s-3)^3}, \quad s > 3. \end{aligned}$$

8. Since  $(1 + e^{-t})^2 = 1 + 2e^{-t} + e^{-2t}$ , we have from the linearity of the Laplace transform that

$$\mathcal{L}\{(1 + e^{-t})^2\}(s) = \mathcal{L}\{1\}(s) + 2\mathcal{L}\{e^{-t}\}(s) + \mathcal{L}\{e^{-2t}\}(s).$$

From Table 7.1 of the text, we get

$$\mathcal{L}\{1\}(s) = \frac{1}{s}, \quad \mathcal{L}\{e^{-t}\}(s) = \frac{1}{s+1}, \quad \mathcal{L}\{e^{-2t}\}(s) = \frac{1}{s+2}.$$

Thus

$$\mathcal{L}\{(1 + e^{-t})^2\}(s) = \frac{1}{s} + \frac{2}{s+1} + \frac{1}{s+2}, \quad s > 0.$$

## Chapter 7

10. Since

$$\mathcal{L}\{e^{2t} \cos 5t\}(s) = \frac{s-2}{(s-2)^2 + 25},$$

we use Theorem 6 to get

$$\begin{aligned} \mathcal{L}\{te^{2t} \cos 5t\}(s) &= \mathcal{L}\{t(e^{2t} \cos 5t)\}(s) = -[\mathcal{L}\{e^{2t} \cos 5t\}(s)]' = -\left[\frac{s-2}{(s-2)^2 + 25}\right]' \\ &= -\frac{[(s-2)^2 + 25] - (s-2) \cdot 2(s-2)}{[(s-2)^2 + 25]^2} = \frac{(s-2)^2 - 25}{[(s-2)^2 + 25]^2}. \end{aligned}$$

12. Since  $\sin 3t \cos 3t = (1/2) \sin 6t$ , we obtain

$$\mathcal{L}\{\sin 3t \cos 3t\}(s) = \frac{1}{2} \mathcal{L}\{\sin 6t\}(s) = \frac{1}{2} \frac{6}{s^2 + 6^2} = \frac{3}{s^2 + 36}.$$

14. In this problem, we need the trigonometric identity  $\sin^2 t = (1 - \cos 2t)/2$  and the linearity of the Laplace transform.

$$\begin{aligned} \mathcal{L}\{e^{7t} \sin^2 t\}(s) &= \mathcal{L}\left\{e^{7t} \frac{1 - \cos 2t}{2}\right\}(s) = \frac{1}{2} [\mathcal{L}\{e^{7t}\}(s) - \mathcal{L}\{e^{7t} \cos 2t\}(s)] \\ &= \frac{1}{2} \left[ \frac{1}{s-7} - \frac{s-7}{(s-7)^2 + 4} \right] = \frac{2}{(s-7)[(s-7)^2 + 4]}. \end{aligned}$$

16. Since

$$t \sin^2 t = \frac{t(1 - \cos 2t)}{2},$$

we write

$$\begin{aligned} \mathcal{L}\{t \sin^2 t\}(s) &= \frac{1}{2} [\mathcal{L}\{t\}(s) - \mathcal{L}\{t \cos 2t\}(s)] \\ &= \frac{1}{2} \left[ \frac{1}{s^2} + \left( \frac{s}{s^2 + 4} \right)' \right] = \frac{1}{2} \left[ \frac{1}{s^2} + \frac{4 - s^2}{(s^2 + 4)^2} \right], \end{aligned}$$

which holds for  $s > 0$ .

18. Since  $\cos A \cos B = [\cos(A - B) + \cos(A + B)]/2$ , we get

$$\begin{aligned} \mathcal{L}\{\cos nt \cos mt\}(s) &= \mathcal{L}\left\{ \frac{\cos(n-m)t + \cos(n+m)t}{2} \right\}(s) \\ &= \frac{1}{2} [\mathcal{L}\{\cos(n-m)t\}(s) + \mathcal{L}\{\cos(n+m)t\}(s)] \\ &= \frac{1}{2} \left[ \frac{s}{s^2 + (n-m)^2} + \frac{s}{s^2 + (n+m)^2} \right] \\ &= \frac{s(s^2 + n^2 + m^2)}{[s^2 + (n-m)^2][s^2 + (n+m)^2]}. \end{aligned}$$

20. Since  $\sin A \sin B = [\cos(A - B) - \cos(A + B)]/2$ , using the linearity of the Laplace transform and Theorem 6, we get

$$\begin{aligned} \mathcal{L}\{t \sin 2t \sin 5t\}(s) &= -\frac{d}{ds} \mathcal{L}\left\{\frac{\cos 3t - \cos 7t}{2}\right\}(s) = -\frac{1}{2} \frac{d}{ds} \left(\frac{s}{s^2 + 9} - \frac{s}{s^2 + 49}\right) \\ &= -20 \left[\frac{s}{(s^2 + 9)(s^2 + 49)}\right]' = \frac{20(3s^4 + 58s^2 - 441)}{(s^2 + 9)^2(s^2 + 49)^2}. \end{aligned}$$

22. We represent  $t^n = t^n \cdot 1$  and apply (6) to get

$$\begin{aligned} \mathcal{L}\{t^n\}(s) &= \mathcal{L}\{t^n \cdot 1\}(s) = (-1)^n \frac{d^n}{ds^n} [\mathcal{L}\{1\}(s)] = (-1)^n \frac{d^n (s^{-1})}{ds^n} \\ &= (-1)^n (-1)(-2) \cdots (-n) s^{-1-n} = \frac{(-1)^n (-1)^{n-1} \cdot 2 \cdots n}{s^{n+1}} = \frac{n!}{s^{n+1}}. \end{aligned}$$

24. (a) Applying (1), the “translation in  $s$ ” property of the Laplace transform, to  $f(t) = t^n$  yields

$$\mathcal{L}\{e^{at}t^n\}(s) = \mathcal{L}\{t^n\}(s - a) = \frac{n!}{(s - a)^{n+1}}, \quad s > a.$$

(b) We apply (6) to the Laplace transform of  $f(t) = e^{at}$ , which is of exponential order  $a$ .

$$\begin{aligned} \mathcal{L}\{t^n e^{at}\}(s) &= (-1)^n \frac{d^n}{ds^n} [\mathcal{L}\{e^{at}\}(s)] = (-1)^n \frac{d^n [(s - a)^{-1}]}{ds^n} \\ &= (-1)^n (-1)(-2) \cdots (-n) (s - a)^{-1-n} = \frac{n!}{(s - a)^{n+1}}, \quad s > a. \end{aligned}$$

26. (a) By Definition 3, there exist constants  $M$ ,  $T$ , and  $\alpha$  such that

$$|f(t)| \leq M e^{\alpha t} \quad \text{for } t \geq T.$$

Since  $f(t)$  is piecewise continuous on  $[0, T]$ , there exists a finite number of points

$$0 = t_0 < t_1 < \cdots < t_n = T$$

such that  $f(t)$  is continuous on each  $(t_j, t_{j+1})$  and has finite one-sided limits at endpoints. This implies that  $f(t)$  is bounded on any closed subinterval of  $(t_{j-1}, t_j)$ , and bounded near the endpoints. Thus,

$$|f(t)| \leq M_j \quad \text{on } (t_j, t_{j+1}), \quad j = 0, 1, \dots, n - 1.$$

Therefore,

$$|f(t)| \leq N = \max_{0 \leq j < n} \{M_j, f(t_j)\} \quad 0 \leq t < T,$$



## Chapter 7

and so

$$|f(t)| \leq (Ne^{-\alpha t}) e^{\alpha t} \leq \sup_{0 \leq t \leq T} (Ne^{-\alpha t}) e^{\alpha t} = Le^{\alpha t}$$

on  $[0, T)$ .

Hence, on  $[0, \infty)$ ,

$$|f(t)| \leq \max\{L, M\}e^{\alpha t} = Ke^{\alpha t}.$$

(b) For  $s > \alpha$ , we have

$$\begin{aligned} 0 &\leq |\mathcal{L}\{f(t)\}(s)| = \left| \int_0^{\infty} f(t)e^{-st} dt \right| \leq \int_0^{\infty} |f(t)|e^{-st} dt \\ &\leq \int_0^{\infty} Ke^{\alpha t}e^{-st} dt = K \int_0^{\infty} e^{(\alpha-s)t} dt = \frac{K}{\alpha-s} e^{(\alpha-s)t} \Big|_{t=0}^{t=\infty} = \frac{K}{s-\alpha}. \end{aligned}$$

Since

$$\lim_{s \rightarrow \infty} \frac{K}{s-\alpha} = 0,$$

by the squeeze theorem

$$\lim_{s \rightarrow \infty} |\mathcal{L}\{f(t)\}(s)| = 0,$$

which is equivalent to

$$\lim_{s \rightarrow \infty} \mathcal{L}\{f(t)\}(s) = 0.$$

**28.** First observe that since both functions  $f(t)$  are continuous on  $[0, \infty)$ , of exponential order  $\alpha$  for any  $\alpha > 0$ , and  $f(t)/t \rightarrow 0$  as  $t \rightarrow 0^+$ . Thus, the formula in Problem 27 applies.

(a) From Table 1,

$$\begin{aligned} F(s) &= \mathcal{L}\{t^5\}(s) = \frac{5!}{s^6} = 5!s^{-6} \\ \Rightarrow \int_s^{\infty} F(u)du &= 5! \int_s^{\infty} u^{-6} du = \frac{5!}{-5} u^{-5} \Big|_s^{\infty} = \frac{4!}{s^5} = \mathcal{L}\{t^4\}(s) = \mathcal{L}\left\{\frac{t^5}{t}\right\}(s). \end{aligned}$$

(b) Here, we use (21) on the inside back cover with  $n = 2$  to conclude that

$$\begin{aligned} F(s) &= \mathcal{L}\{t^{3/2}\}(s) = \frac{3\sqrt{\pi}}{4s^{5/2}} = \frac{3\sqrt{\pi}}{4} s^{-5/2} \\ \Rightarrow \int_s^{\infty} F(u)du &= \frac{3\sqrt{\pi}}{4} \int_s^{\infty} u^{-5/2} du = \frac{3\sqrt{\pi}}{4} \cdot \frac{-2}{3} u^{-3/2} \Big|_s^{\infty} \end{aligned}$$

$$= \frac{\sqrt{\pi}}{2s^{3/2}} = \mathcal{L}\{t^{1/2}\}(s) = \mathcal{L}\left\{\frac{t^{3/2}}{t}\right\}(s).$$

30. From the linearity properties (2) and (3) of the text we have

$$\mathcal{L}\{g\}(s) = \mathcal{L}\{y'' + 5y' + 6y\}(s) = \mathcal{L}\{y''\}(s) + 5\mathcal{L}\{y'\}(s) + 6\mathcal{L}\{y\}(s).$$

Next, applying properties (2) and (4) yields

$$\mathcal{L}\{g\}(s) = [s^2\mathcal{L}\{y\}(s) - sy(0) - y'(0)] + 5[s\mathcal{L}\{y\}(s) - y(0)] + 6\mathcal{L}\{y\}(s).$$

Keeping in mind the fact that both initial values are zero, we get

$$G(s) = (s^2 + 6s + 10)Y(s), \quad \text{where} \quad G(s) = \mathcal{L}\{g\}(s), \quad Y(s) = \mathcal{L}\{y\}(s).$$

Therefore, the transfer function  $H(s)$  is given by

$$H(s) = \frac{Y(s)}{G(s)} = \frac{1}{s^2 + 6s + 10}.$$

32. The graphs of the function  $f(t) = 1$  and its translation  $g(t)$  to the right by  $c = 2$  are shown in Fig. 7-E(a), page 264.

We use the result of Problem 31 to find  $\mathcal{L}\{g(t)\}$ .

$$\mathcal{L}\{g(t)\}(s) = e^{-(2)s}\mathcal{L}\{1\}(s) = \frac{e^{-2s}}{s}.$$

34. The graphs of the function  $f(t) = \sin t$  and its translation  $g(t)$  to the right by  $c = \pi$  units are shown in Fig. 7-E(b).

We use the formula in Problem 31 to find  $\mathcal{L}\{g(t)\}$ .

$$\mathcal{L}\{g(t)\}(s) = e^{-\pi s}\mathcal{L}\{\sin t\}(s) = \frac{e^{-\pi s}}{s^2 + 1}.$$

36. We prove the formula by induction.

(i) Since  $0! = 1$  and

$$\mathcal{L}\{t^0\}(s) = \mathcal{L}\{1\}(s) = \frac{1}{s} = \frac{0!}{s^{0+1}},$$

the formula is correct for  $n = 0$ .

## Chapter 7

- (ii) We now assume that the formula is valid for  $n = k$  and show that it is valid then for  $n = k + 1$ . Indeed, since

$$t^{k+1} = (k+1) \int_0^t \tau^k d\tau,$$

applying (5), we conclude that

$$\begin{aligned} \mathcal{L}\{t^{k+1}\}(s) &= \mathcal{L}\left\{(k+1) \int_0^t \tau^k d\tau\right\}(s) \\ &= (k+1) \frac{1}{s} \mathcal{L}\{t^k\}(s) = (k+1) \frac{1}{s} \frac{k!}{s^{k+1}} = \frac{(k+1)!}{s^{(k+1)+1}}. \end{aligned}$$

Therefore, the formula is valid for any  $n \geq 0$ .

**38.** We have

- (a)  $\lim_{s \rightarrow \infty} s \mathcal{L}\{1\}(s) = \lim_{s \rightarrow \infty} s \cdot \frac{1}{s} = 1;$   
 (b)  $\lim_{s \rightarrow \infty} s \mathcal{L}\{e^t\}(s) = \lim_{s \rightarrow \infty} \frac{s}{s-1} = 1 = e^t \Big|_{t=0};$   
 (c)  $\lim_{s \rightarrow \infty} s \mathcal{L}\{e^{-t}\}(s) = \lim_{s \rightarrow \infty} \frac{s}{s+1} = 1 = e^{-t} \Big|_{t=0};$   
 (d)  $\lim_{s \rightarrow \infty} s \mathcal{L}\{\cos t\}(s) = \lim_{s \rightarrow \infty} \frac{s^2}{s^2+1} = 1 = \cos t \Big|_{t=0};$   
 (e)  $\lim_{s \rightarrow \infty} s \mathcal{L}\{\sin t\}(s) = \lim_{s \rightarrow \infty} \frac{s}{s^2+1} = 0 = \sin t \Big|_{t=0};$   
 (f)  $\lim_{s \rightarrow \infty} s \mathcal{L}\{t^2\}(s) = \lim_{s \rightarrow \infty} \frac{s^2!}{s^3} = 0 = t^2 \Big|_{t=0};$   
 (g)  $\lim_{s \rightarrow \infty} s \mathcal{L}\{t \cos t\}(s) = \lim_{s \rightarrow \infty} \frac{s(s^2-1)}{(s^2+1)^2} = 0 = t \cos t \Big|_{t=0}.$

### EXERCISES 7.4: Inverse Laplace Transform

2. Writing  $2/(s^2+4) = 2/(s^2+2^2)$ , from Table 7.1 (Section 7.2) we get

$$\mathcal{L}^{-1}\left\{\frac{2}{s^2+4}\right\}(t) = \mathcal{L}^{-1}\left\{\frac{2}{s^2+2^2}\right\}(t) = \sin 2t.$$

4. We use the linearity of the inverse Laplace transform and Table 7.1 to conclude that

$$\mathcal{L}^{-1}\left\{\frac{4}{s^2+9}\right\}(t) = \frac{4}{3} \mathcal{L}^{-1}\left\{\frac{3}{s^2+3^2}\right\}(t) = \frac{4}{3} \sin 3t.$$

6. The linearity of the inverse Laplace transform and Table 7.1 yields

$$\mathcal{L}^{-1} \left\{ \frac{3}{(2s+5)^3} \right\} (t) = \frac{3}{8} \mathcal{L}^{-1} \left\{ \frac{1}{(s+5/2)^3} \right\} (t) = \frac{3}{16} t^2 e^{-5t/2}.$$

8. From Table 7.1, the function  $4!/s^5$  is the Laplace transform of  $t^4$ . Therefore,

$$\mathcal{L}^{-1} \left\{ \frac{1}{s^5} \right\} (t) = \frac{1}{4!} \mathcal{L}^{-1} \left\{ \frac{4!}{s^5} \right\} (t) = \frac{1}{24} t^4.$$

10. By completing the square in the denominator, we get

$$\begin{aligned} \frac{s-1}{2s^2+s+3} &= \frac{1}{2} \frac{s-1}{(s+1/4)^2 + (\sqrt{47}/4)^2} \\ &= \frac{1}{2} \left[ \frac{s+(1/4)}{(s+1/4)^2 + (\sqrt{47}/4)^2} - \frac{5}{\sqrt{47}} \frac{\sqrt{47}/4}{(s+1/4)^2 + (\sqrt{47}/4)^2} \right] \end{aligned}$$

so that

$$\mathcal{L}^{-1} \left\{ \frac{s-1}{2s^2+s+3} \right\} (t) = \frac{1}{2} e^{-t/4} \cos \left( \frac{\sqrt{47}t}{4} \right) - \frac{5}{2\sqrt{47}} e^{-t/4} \sin \left( \frac{\sqrt{47}t}{4} \right).$$

(See the Laplace transforms for  $e^{\alpha t} \sin bt$  and  $e^{\alpha t} \cos bt$  in Table 7.1).

12. In this problem, we use the partial fractions decomposition method. Since the denominator,  $(s+1)(s-2)$ , is a product of two nonrepeated linear factors, the expansion has the form

$$\frac{-s-7}{(s+1)(s-2)} = \frac{A}{s+1} + \frac{B}{s-2} = \frac{A(s-2) + B(s+1)}{(s+1)(s-2)}.$$

Therefore,

$$-s-7 = A(s-2) + B(s+1). \quad (7.1)$$

Evaluating both sides of (7.1) at  $s = -1$  and  $s = 2$ , we find constants  $A$  and  $B$ .

$$\begin{aligned} s = -1 : \quad -6 &= -3A \quad \Rightarrow \quad A = 2, \\ s = 2 : \quad -9 &= 3B \quad \Rightarrow \quad B = -3. \end{aligned}$$

Hence,

$$\frac{-s-7}{(s+1)(s-2)} = \frac{2}{s+1} - \frac{3}{s-2}.$$

14. First, we factor the denominator completely. Since  $s^2 - 3s + 2 = (s-1)(s-2)$ , we have

$$\frac{-8s^2 - 5s + 9}{(s+1)(s^2 - 3s + 2)} = \frac{-8s^2 - 5s + 9}{(s+1)(s-1)(s-2)}.$$

## Chapter 7

Since the denominator has only nonrepeated linear factors, we can write

$$\frac{-8s^2 - 5s + 9}{(s+1)(s-1)(s-2)} = \frac{A}{s+1} + \frac{B}{s-1} + \frac{C}{s-2}.$$

for some  $A$ ,  $B$  and  $C$ . Clearing fractions gives us

$$-8s^2 - 5s + 9 = A(s-1)(s-2) + B(s+1)(s-2) + C(s+1)(s-1).$$

With  $s = -1$ , this yields  $6 = A(-2)(-3)$  so that  $A = 1$ . Substituting  $s = 1$ , we get  $-4 = B(2)(-1)$  so that  $B = 2$ . Finally,  $s = 2$  yields  $-33 = C(3)(1)$  so that  $C = -11$ . Thus,

$$\frac{-8s^2 - 5s + 9}{(s+1)(s^2 - 3s + 2)} = \frac{1}{s+1} + \frac{2}{s-1} - \frac{11}{s-2}.$$

**16.** Since the denominator has one linear and one irreducible quadratic factors, we have

$$\frac{-5s - 36}{(s+2)(s^2 + 9)} = \frac{A}{s+2} + \frac{Bs + C(3)}{s^2 + 3^2} = \frac{A(s^2 + 9) + (Bs + 3C)(s+2)}{(s+2)[s^2 + 9]},$$

which implies that

$$-5s - 36 = A(s^2 + 9) + (Bs + 3C)(s+2).$$

Taking  $s = -2$ ,  $s = 0$ , and  $s = 1$ , we find  $A$ ,  $C$ , and  $B$ , respectively.

$$\begin{aligned} s = -2 : \quad -26 &= 13A & \Rightarrow & \quad A = -2, \\ s = 0 : \quad -36 &= 9A + 6C & \Rightarrow & \quad C = -3, \\ s = 1 : \quad -41 &= 10A + 3(B + 3C) & \Rightarrow & \quad B = 2, \end{aligned}$$

and so

$$\frac{-5s - 36}{(s+2)(s^2 + 9)} = -2 \frac{1}{s+2} + 2 \frac{s}{s^2 + 9} - 3 \frac{3}{s^2 + 9}.$$

**18.** We have

$$\frac{3s^2 + 5s + 3}{s^4 + s^3} = \frac{3s^2 + 5s + 3}{s^3(s+1)} = \frac{A}{s^3} + \frac{B}{s^2} + \frac{C}{s} + \frac{D}{s+1}. \quad (7.2)$$

Multiplying this equation by  $s+1$  and evaluating the result at  $s = -1$  yields

$$\left. \frac{3s^2 + 5s + 3}{s^3} \right|_{s=-1} = (s+1) \left( \frac{A}{s^3} + \frac{B}{s^2} + \frac{C}{s} \right) + D \Big|_{s=-1} \Rightarrow D = -1.$$

We can find  $A$  by multiplying (7.2) by  $s^3$  and substituting  $s = 0$ .

$$\left. \frac{3s^2 + 5s + 3}{s+1} \right|_{s=0} = A + Bs + Cs^2 + \frac{Ds^3}{s+1} \Big|_{s=0} \Rightarrow A = 3.$$

Thus,

$$\begin{aligned}\frac{3s^2 + 5s + 3}{s^3(s+1)} &= \frac{3}{s^3} + \frac{B}{s^2} + \frac{C}{s} - \frac{1}{s+1} \\ \Rightarrow 3s^2 + 5s + 3 &= 3(s+1) + Bs(s+1) + Cs^2(s+1) - s^3.\end{aligned}\quad (7.3)$$

One can now compare the coefficients at  $s^3$  and  $s$  to find  $B$  and  $C$ . Alternatively, differentiating (7.3) and evaluating the derivatives at  $s = 0$  yields

$$6s + 5|_{s=0} = 5 = 3 + B(2s + 1)|_{s=0} = 3 + B \quad \Rightarrow \quad B = 2.$$

(The last two terms in the right-hand side of (7.3) have zero derivative at  $s = 0$ .) Similarly, evaluating the second derivative in (7.3) at  $s = 0$ , we find that

$$6 = 2B + C(6s + 2)|_{s=0} = 4 + 2C \quad \Rightarrow \quad C = 1.$$

Therefore,

$$\frac{3s^2 + 5s + 3}{s^4 + s^3} = \frac{3}{s^3} + \frac{2}{s^2} + \frac{1}{s} - \frac{1}{s+1}.$$

**20.** Factoring the denominator completely yields

$$\begin{aligned}\frac{s}{(s-1)(s^2-1)} &= \frac{s}{(s-1)^2(s+1)} = \frac{A}{(s-1)^2} + \frac{B}{s-1} + \frac{C}{s+1} \\ &= \frac{A(s+1) + B(s^2-1) + C(s-1)^2}{(s-1)^2(s+1)}.\end{aligned}$$

Thus,

$$s = A(s+1) + B(s^2-1) + C(s-1)^2.\quad (7.4)$$

Evaluating this equality at  $s = 1$  and  $s = -1$ , we find  $A$  and  $C$ , respectively.

$$\begin{aligned}s = 1: \quad 1 &= 2A \quad \Rightarrow \quad A = 1/2, \\ s = -1: \quad -1 &= 4C \quad \Rightarrow \quad C = -1/4.\end{aligned}$$

To find  $B$ , we evaluate both sides of (7.4) at, say,  $s = 0$ .

$$0 = A - B + C \quad \Rightarrow \quad B = A + C = 1/4.$$

Hence,

$$\frac{s}{(s-1)(s^2-1)} = \frac{1}{2} \frac{1}{(s-1)^2} + \frac{1}{4} \frac{1}{s-1} - \frac{1}{4} \frac{1}{s+1}.$$

## Chapter 7

- 22.** Since the denominator contains only nonrepeated linear factors, the partial fractions decomposition has the form

$$\begin{aligned}\frac{s+11}{(s-1)(s+3)} &= \frac{A}{s-1} + \frac{B}{s+3} = \frac{A(s+3) + B(s-1)}{(s-1)(s+3)} \\ \Rightarrow s+11 &= A(s+3) + B(s-1).\end{aligned}$$

At  $s = 1$ , this yields  $A = 3$ , and we find that  $B = -2$  substituting  $s = -3$ . Therefore,

$$\frac{s+11}{(s-1)(s+3)} = 3\frac{1}{s-1} - 2\frac{1}{s+3},$$

and the linear property of the inverse Laplace transform yields

$$\mathcal{L}^{-1}\left\{\frac{s+11}{(s-1)(s+3)}\right\} = 3\mathcal{L}^{-1}\left\{\frac{1}{s-1}\right\} - 2\mathcal{L}^{-1}\left\{\frac{1}{s+3}\right\} = 3e^t - 2e^{-3t}.$$

- 24.** Observing that the quadratic  $s^2 - 4s + 13 = (s-2)^2 + 3^2$  is irreducible, the partial fractions decomposition for  $F(s)$  has the form

$$\frac{7s^2 - 41s + 84}{(s-1)(s^2 - 4s + 13)} = \frac{A}{s-1} + \frac{B(s-2) + C(3)}{(s-2)^2 + 3^2}.$$

Clearing fractions gives us

$$7s^2 - 41s + 84 = A[(s-2)^2 + 9] + [B(s-2) + C(3)](s-1).$$

With  $s = 1$ , this yields  $50 = 10A$  so that  $A = 5$ ;  $s = 2$  gives  $30 = A(9) + C(3)$ , or  $C = -5$ . Finally, the coefficient  $A + B$  at  $s^2$  in the right-hand side must match the one in the left-hand side, which is 7. So  $B = 7 - A = 2$ . Therefore,

$$\frac{7s^2 - 41s + 84}{(s-1)(s^2 - 4s + 13)} = 5\frac{1}{s-1} + 2\frac{s-2}{(s-2)^2 + 3^2} - 5\frac{3}{(s-2)^2 + 3^2},$$

which yields

$$\begin{aligned}\mathcal{L}^{-1}\left\{\frac{7s^2 - 41s + 84}{(s-1)(s^2 - 4s + 13)}\right\} &= 5\mathcal{L}^{-1}\left\{\frac{1}{s-1}\right\} + 2\mathcal{L}^{-1}\left\{\frac{s-2}{(s-2)^2 + 3^2}\right\} \\ &\quad - 5\mathcal{L}^{-1}\left\{\frac{3}{(s-2)^2 + 3^2}\right\} \\ &= 5e^t + 2e^{2t}\cos 3t - 5e^{2t}\sin 3t.\end{aligned}$$

- 26.** The partial fractions decomposition has the form

$$F(s) = \frac{A}{s^3} + \frac{B}{s^2} + \frac{C}{s} + \frac{D}{s-2}. \quad (7.5)$$

Multiplying (7.5) by  $s^3$  and substituting  $s = 0$  yields

$$\left. \frac{7s^3 - 2s^2 - 3s + 6}{s - 2} \right|_{s=0} = -3 = A + Bs + Cs^2 + \left. \frac{Ds^3}{s - 2} \right|_{s=0} = A.$$

Thus,  $A = -3$ . Multiplying (7.5) by  $s - 2$  and evaluating the result at  $s = 2$ , we get

$$\left. \frac{7s^3 - 2s^2 - 3s + 6}{s^3} \right|_{s=2} = 6 = (s - 2) \left[ -\frac{3}{s^3} + \frac{B}{s^2} + \frac{C}{s} \right] + D \Big|_{s=2} = D.$$

So,  $D = 6$  and (7.5) becomes

$$\frac{7s^3 - 2s^2 - 3s + 6}{s^3(s - 2)} = -\frac{3}{s^3} + \frac{B}{s^2} + \frac{C}{s} + \frac{6}{s - 2}.$$

Clearing the fractions yields

$$7s^3 - 2s^2 - 3s + 6 = -3(s - 2) + Bs(s - 2) + Cs^2(s - 2) + 6s^3.$$

Matching the coefficients at  $s^3$ , we obtain  $C + 6 = 7$  or  $C = 1$ . Finally, the coefficients at  $s^2$  lead to  $B - 2C = -2$  or  $B = 0$ . Therefore,

$$F(s) = \frac{7s^3 - 2s^2 - 3s + 6}{s^3(s - 2)} = -\frac{3}{s^3} + \frac{1}{s} + \frac{6}{s - 2}$$

and

$$\mathcal{L}^{-1}\{F(s)\}(t) = -\frac{3}{2}t^2 + 1 + 6e^{2t}.$$

**28.** First, we find  $F(s)$ .

$$\begin{aligned} F(s)(s^2 + s - 6) &= \frac{s^2 + 4}{s^2 + s} \\ \Rightarrow F(s) &= \frac{s^2 + 4}{s(s + 1)(s^2 + s - 6)} = \frac{s^2 + 4}{s(s + 1)(s + 3)(s - 2)}. \end{aligned}$$

The partial fractions expansion yields

$$\frac{s^2 + 4}{s(s + 1)(s + 3)(s - 2)} = \frac{A}{s} + \frac{B}{s + 1} + \frac{C}{s + 3} + \frac{D}{s - 2}.$$

Clearing fractions gives us

$$s^2 + 4 = A(s + 1)(s + 3)(s - 2) + Bs(s + 3)(s - 2) + Cs(s + 1)(s - 2) + Ds(s + 1)(s + 3).$$

With  $s = 0$ ,  $s = -1$ ,  $s = -3$ , and  $s = 2$  this yields  $A = -2/3$ ,  $B = 5/6$ ,  $C = -13/30$ , and  $D = 4/15$ . So,

$$\mathcal{L}^{-1}\{F(s)\}(t) = -\frac{2}{3}\mathcal{L}^{-1}\left\{\frac{1}{s}\right\}(t) + \frac{5}{6}\mathcal{L}^{-1}\left\{\frac{1}{s + 1}\right\}(t)$$



$$\begin{aligned}
& -\frac{13}{30}\mathcal{L}^{-1}\left\{\frac{1}{s+3}\right\}(t) + \frac{4}{15}\mathcal{L}^{-1}\left\{\frac{1}{s-2}\right\}(t) \\
& = -\frac{2}{3} + \frac{5}{6}e^{-t} - \frac{13}{30}e^{-3t} + \frac{4}{15}e^{2t}.
\end{aligned}$$

**30.** Solving for  $F(s)$  yields

$$F(s) = \frac{2s+5}{(s-1)(s^2+2s+1)} = \frac{A}{(s+1)^2} + \frac{B}{s+1} + \frac{C}{s-1}. \quad (7.6)$$

Thus, clearing fractions, we conclude that

$$2s+5 = A(s-1) + B(s^2-1) + C(s+1)^2.$$

Substitution  $s = 1$  into this equation yields  $C = 7/4$ . With  $s = -1$ , we get  $A = -3/2$ . Finally, substitution  $s = 0$  results  $5 = -A - B + C$  or  $B = -A + C - 5 = -7/4$ . Now we use the linearity of the inverse Laplace transform and obtain

$$\begin{aligned}
\mathcal{L}^{-1}\{F(s)\}(t) & = -\frac{3}{2}\mathcal{L}^{-1}\left\{\frac{1}{(s+1)^2}\right\}(t) - \frac{7}{4}\mathcal{L}^{-1}\left\{\frac{1}{s+1}\right\}(t) + \frac{7}{4}\mathcal{L}^{-1}\left\{\frac{1}{s-1}\right\}(t) \\
& = -\frac{3}{2}te^{-t} - \frac{7}{4}e^{-t} + \frac{7}{4}e^t.
\end{aligned}$$

**32.** Functions  $f_1(t)$ ,  $f_2(t)$ , and  $f_3(t)$  coincide for all  $t$  in  $[0, \infty)$  except for a discrete set of points. Since the Laplace transform of a function is a definite integral, it does not depend on values of the function at these points. Therefore, in (a), (b), and (c) we have one and the same Laplace transform, that is

$$\mathcal{L}\{f_1(t)\}(s) = \mathcal{L}\{f_2(t)\}(s) = \mathcal{L}\{f_3(t)\}(s) = \mathcal{L}\{e^t\}(s) = \frac{1}{s-1}.$$

$f_3(t) = e^t$  is continuous on  $[0, \infty]$  while  $f_1(t)$  and  $f_2(t)$  have (removable) discontinuities at  $t = 1, 2, \dots$  and  $t = 5, 8$ , respectively. By Definition 4, then

$$\mathcal{L}^{-1}\left\{\frac{1}{s-1}\right\}(t) = f_3(t) = e^t.$$

**34.** We are looking for  $\mathcal{L}^{-1}\{F(s)\}(t) = f(t)$ . According to the formula given just before this problem (with  $n = 1$ ),

$$f(t) = \frac{-1}{t}\mathcal{L}^{-1}\left\{\frac{dF}{ds}\right\}(t)$$

Since

$$F(s) = \ln\left(\frac{s-4}{s-3}\right) = \ln(s-4) - \ln(s-3),$$

we have

$$\begin{aligned}\frac{dF(s)}{ds} &= \frac{d}{ds} [\ln(s-4) - \ln(s-3)] = \frac{1}{s-4} - \frac{1}{s-3} \\ \Rightarrow \mathcal{L}^{-1} \left\{ \frac{dF}{ds} \right\} (t) &= \mathcal{L}^{-1} \left\{ \frac{1}{s-4} - \frac{1}{s-3} \right\} (t) = e^{4t} - e^{3t} \\ \Rightarrow \mathcal{L}^{-1} \{F(s)\} (t) &= \frac{-1}{t} (e^{4t} - e^{3t}) = \frac{e^{3t} - e^{4t}}{t}.\end{aligned}$$

**36.** Taking the derivative of  $F(s)$ , we get

$$\frac{dF(s)}{ds} = \frac{d}{ds} \arctan \left( \frac{1}{s} \right) = \frac{1}{1 + (1/s)^2} \frac{d}{ds} \left( \frac{1}{s} \right) = -\frac{1}{s^2 + 1}.$$

So, from Table 7.1, Section 7.2, we have

$$\mathcal{L}^{-1} \left\{ \frac{dF(s)}{ds} \right\} (t) = -\sin t.$$

Thus,

$$\mathcal{L}^{-1} \{F(s)\} (t) = \frac{-1}{t} \mathcal{L}^{-1} \left\{ \frac{dF(s)}{ds} \right\} (t) = \frac{\sin t}{t}.$$

**38.** Since  $s = r$  is a simple root of  $Q(s)$ , we can write  $Q(s) = (s-r)\tilde{Q}(s)$ , where  $\tilde{Q}(r) \neq 0$ .

Therefore,

$$\lim_{s \rightarrow r} \frac{(s-r)P(s)}{Q(s)} = \lim_{s \rightarrow r} \frac{(s-r)P(s)}{(s-r)\tilde{Q}(s)} = \frac{P(r)}{\tilde{Q}(r)} =: A.$$

Thus, the function  $(s-r)P(s)/Q(s) - A$  is a rational function satisfying

$$\lim_{s \rightarrow r} \left[ \frac{(s-r)P(s)}{Q(s)} - A \right] = 0.$$

Therefore,

$$\frac{(s-r)P(s)}{Q(s)} - A = (s-r)\tilde{R}(s),$$

where  $\tilde{R}(s)$  has a finite limit at  $s = r$  meaning that its denominator, which is (in the reduced form)  $\tilde{Q}(s)$  is not zero at  $s = r$ . Thus,

$$\frac{P(s)}{Q(s)} = \frac{A + (s-r)\tilde{R}(s)}{s-r} = \frac{A}{s-r} + \tilde{R}(s).$$

It is worth mentioning that

$$A = \lim_{s \rightarrow r} \frac{(s-r)P(s)}{Q(s)} = \lim_{s \rightarrow r} \frac{P(s)}{Q(s)/(s-r)} = \frac{P(r)}{Q'(r)}. \quad (7.7)$$

## Chapter 7

40. Since  $s - r_j$ ,  $j = 1, 2, \dots, n$ , are simple linear factors of  $Q(s)$ , applying Problem 38 repeatedly, we conclude that the partial fractions decomposition of  $P(s)/Q(s)$  has the form

$$\frac{P(s)}{Q(s)} = \sum_{j=1}^n \frac{A_j}{s - r_j}.$$

Multiplying this equation by  $s - r_i$  and taking the limit, as  $s \rightarrow r_i$ , yields

$$\lim_{s \rightarrow r_i} \frac{(s - r_i)P(s)}{Q(s)} = \lim_{s \rightarrow r_i} \left[ (s - r_i) \sum_{j=1}^n \frac{A_j}{s - r_j} \right] = \lim_{s \rightarrow r_i} \left[ A_i + (s - r_i) \sum_{j \neq i} \frac{A_j}{s - r_j} \right] = A_i.$$

Similarly to (7.7), we conclude that

$$A_i = \frac{P(r_i)}{Q'(r_i)}$$

so that

$$\frac{P(s)}{Q(s)} = \sum_{i=1}^n \frac{P(r_i)}{Q'(r_i)} \frac{1}{s - r_i}.$$

Using now the linearity of the inverse Laplace transform, we get

$$\mathcal{L}^{-1} \left\{ \frac{P(s)}{Q(s)} \right\} (t) = \sum_{i=1}^n \frac{P(r_i)}{Q'(r_i)} \mathcal{L}^{-1} \left\{ \frac{1}{s - r_i} \right\} (t) = \sum_{i=1}^n \frac{P(r_i)}{Q'(r_i)} e^{r_i t}.$$

42. Similarly to Problem 38, we conclude that

$$\lim_{s \rightarrow \alpha + i\beta} \frac{[(s - \alpha)^2 + \beta^2] P(s)}{Q(s)} = A + iB$$

so that

$$\lim_{s \rightarrow \alpha - i\beta} \frac{[(s - \alpha)^2 + \beta^2] P(s)}{Q(s)} = \overline{\lim_{s \rightarrow \alpha + i\beta} \frac{[(s - \alpha)^2 + \beta^2] P(s)}{Q(s)}} = A - iB$$

since  $P(s)$  and  $Q(s)$  are polynomial with real coefficients. Therefore,

$$\frac{P(s)}{Q(s)} = \frac{A + iB}{s - (\alpha + i\beta)} + \frac{A - iB}{s - (\alpha - i\beta)} + \tilde{R}(s),$$

where  $\tilde{R}(s)$  has finite limits as  $s \rightarrow \alpha \pm i\beta$ . Simplifying yields

$$\begin{aligned} \frac{P(s)}{Q(s)} &= \frac{(A + iB)[s - (\alpha - i\beta)] + (A - iB)[s - (\alpha + i\beta)]}{(s - \alpha)^2 + \beta^2} + \tilde{R}(s) \\ &= \frac{2A(s - \alpha) - 2B\beta}{(s - \alpha)^2 + \beta^2} + \tilde{R}(s). \end{aligned}$$

Re-denoting  $2A$  by  $A$  and  $-2B$  by  $B$ , we get the required formula

$$\frac{P(s)}{Q(s)} = \frac{A(s - \alpha) + B\beta}{(s - \alpha)^2 + \beta^2} + \tilde{R}(s).$$

Multiplying this representation by  $(s - \alpha)^2 + \beta^2$  and taking the limit yields

$$\begin{aligned} \lim_{s \rightarrow \alpha + i\beta} \frac{[(s - \alpha)^2 + \beta^2] P(s)}{Q(s)} \\ = \lim_{s \rightarrow \alpha + i\beta} \left\{ A(s - \alpha) + B\beta + [(s - \alpha)^2 + \beta^2] \tilde{R}(s) \right\} = B\beta + iA\beta. \end{aligned}$$

### EXERCISES 7.5: Solving Initial Value Problems

2. Let  $Y = Y(s) := \mathcal{L}\{y(t)\}(s)$ .<sup>1</sup> Applying the Laplace transform to both sides of the given equation and using Theorem 5 in Section 7.3 to express  $\mathcal{L}\{y''\}$  and  $\mathcal{L}\{y'\}$  in terms of  $Y$ , we obtain

$$\begin{aligned} (s^2Y + 2s - 5) - (sY + 2) - 2Y &= 0 \\ \Rightarrow Y &= \frac{1}{s^2 - s - 2} (7 - 2s) = \frac{7 - 2s}{(s - 2)(s + 1)} = \frac{1}{s - 2} - \frac{3}{s + 1}. \end{aligned}$$

Taking now the inverse Laplace transform and using its linearity and Table 7.1 from Section 7.2 yields

$$y(t) = \mathcal{L}^{-1} \left\{ \frac{1}{s - 2} - \frac{3}{s + 1} \right\} (t) = e^{2t} - 3e^{-t}.$$

4. Applying the Laplace transform to both sides of the given equation and using Theorem 5 in Section 7.3 to express  $\mathcal{L}\{y''\}$  and  $\mathcal{L}\{y'\}$  in terms of  $Y$ , we obtain

$$\begin{aligned} (s^2Y + s - 7) + 6(sY + 1) + 5Y &= \frac{12}{s - 1} \\ \Rightarrow Y &= \frac{1}{s^2 + 6s + 5} \left( 1 - s + \frac{12}{s - 1} \right) \\ &= \frac{-s^2 + 2s + 11}{(s + 1)(s + 5)(s - 1)} = \frac{1}{s - 1} - \frac{1}{s + 5} - \frac{1}{s + 1}. \end{aligned}$$

Taking now the inverse Laplace transform and using its linearity and Table 7.1 from Section 7.2 yields

$$y(t) = \mathcal{L}^{-1} \left\{ \frac{1}{s - 1} - \frac{1}{s + 5} - \frac{1}{s + 1} \right\} (t) = e^t - e^{-5t} - e^{-t}.$$

<sup>1</sup>We will use this notation in all solutions in Section 7.5.

## Chapter 7

6. Applying the Laplace transform to both sides of the given equation and using Theorem 5 in Section 7.3 to express  $\mathcal{L}\{y''\}$  and  $\mathcal{L}\{y'\}$  in terms of  $Y$ , we obtain

$$\begin{aligned}(s^2Y - 2s - 7) - 4(sY - 2) + 5Y &= \frac{4}{s-3} \\ \Rightarrow Y &= \frac{1}{s^2 - 4s + 5} \left( 2s - 1 + \frac{4}{s-3} \right) \\ &= \frac{2s^2 - 7s + 7}{(s-3)[(s-2)^2 + 1^2]} = \frac{2}{s-3} + \frac{1}{(s-2)^2 + 1^2}.\end{aligned}$$

Taking now the inverse Laplace transform and using its linearity and Table 7.1 from Section 7.2 yields

$$y(t) = \mathcal{L}^{-1} \left\{ \frac{2}{s-3} + \frac{1}{(s-2)^2 + 1^2} \right\} (t) = 2e^{3t} + e^{2t} \sin t.$$

8. Applying the Laplace transform to both sides of the given equation and using Theorem 5 in Section 7.3 to express  $\mathcal{L}\{y''\}$  and  $\mathcal{L}\{y'\}$  in terms of  $Y$ , we obtain

$$\begin{aligned}(s^2Y - 3) + 4Y &= \frac{8}{s^3} - \frac{4}{s^2} + \frac{10}{s} \\ \Rightarrow Y &= \frac{1}{s^2 + 4} \left( 3 + \frac{8}{s^3} - \frac{4}{s^2} + \frac{10}{s} \right) \\ &= \frac{3s^3 + 10s^2 - 4s + 8}{s^3(s^2 + 2^2)} = \frac{2}{s^3} - \frac{1}{s^2} + \frac{2}{s} - 2 \frac{s}{s^2 + 2^2} + 2 \frac{2}{s^2 + 2^2}.\end{aligned}$$

Taking now the inverse Laplace transform and using its linearity and Table 7.1 from Section 7.2 yields

$$y(t) = \mathcal{L}^{-1} \left\{ \frac{2}{s^3} - \frac{1}{s^2} + \frac{2}{s} - 2 \frac{s}{s^2 + 2^2} + 2 \frac{2}{s^2 + 2^2} \right\} (t) = t^2 - t + 2 - 2 \cos 2t + 2 \sin 2t.$$

10. Applying the Laplace transform to both sides of the given equation and using Theorem 5 in Section 7.3 to express  $\mathcal{L}\{y''\}$  and  $\mathcal{L}\{y'\}$  in terms of  $Y$ , we obtain

$$\begin{aligned}(s^2Y - 5) - 4Y &= \frac{4}{s^2} - \frac{8}{s+2} \\ \Rightarrow Y &= \frac{1}{s^2 - 4} \left( 5 + \frac{4}{s^2} - \frac{8}{s+2} \right) \\ &= \frac{5s^3 + 2s^2 + 4s + 8}{s^2(s+2)^2(s-2)} = \frac{2}{(s+2)^2} - \frac{1}{s+2} - \frac{1}{s^2} + \frac{1}{s-2}.\end{aligned}$$

Taking now the inverse Laplace transform and using its linearity and Table 7.1 from Section 7.2 yields

$$y(t) = \mathcal{L}^{-1} \left\{ \frac{2}{(s+2)^2} - \frac{1}{s+2} - \frac{1}{s^2} + \frac{1}{s-2} \right\} (t) = 2te^{-2t} - e^{-2t} - t + e^{2t}.$$

12. Since the Laplace transform approach requires that initial conditions are given at the origin, we make a shift in argument. Namely, let  $y(t) := w(t - 1)$ . Then

$$\begin{aligned}y'(t) &= w'(t - 1)(t - 1)' = w'(t - 1), \\y''(t) &= w''(t - 1)(t - 1)' = w''(t - 1).\end{aligned}$$

Thus, replacing  $t$  by  $t - 1$  in the given equation yields

$$y'' - 2y' + y = 6(t - 1) - 2 = 6t - 8$$

with the initial conditions  $y(0) = w(-1) = 3$ ,  $y'(0) = w'(-1) = 7$ .

Applying the Laplace transform to both sides of this equation and using Theorem 5 in Section 7.3 to express  $\mathcal{L}\{y''\}$  and  $\mathcal{L}\{y'\}$  in terms of  $Y$ , we obtain

$$\begin{aligned}(s^2Y - 3s - 7) - 2(sY - 3) + Y &= \frac{6}{s^2} - \frac{8}{s} \\ \Rightarrow Y &= \frac{1}{s^2 - 2s + 1} \left( 3s + 1 + \frac{6}{s^2} - \frac{8}{s} \right) \\ &= \frac{3s^3 + s^2 - 8s + 6}{s^2(s - 1)^2} = \frac{6}{s^2} + \frac{4}{s} - \frac{1}{s - 1} + \frac{2}{(s - 1)^2}.\end{aligned}$$

Taking now the inverse Laplace transform and using its linearity and Table 7.1 from Section 7.2 yields

$$y(t) = \mathcal{L}^{-1} \left\{ \frac{6}{s^2} + \frac{4}{s} - \frac{1}{s - 1} + \frac{2}{(s - 1)^2} \right\} (t) = 6t + 4 - e^t + 2te^t.$$

Finally, shifting the argument back, we get

$$w(t) = y(t + 1) = 6t + 10 - e^{t+1} + 2(t + 1)e^{t+1} = 6t + 10 + e^{t+1} + 2te^{t+1}.$$

14. Similarly to Problem 12, we make a shift in argument first. Let  $w(t) := y(t + \pi)$ . Then

$$\begin{aligned}w'(t) &= y'(t + \pi)(t + \pi)' = y'(t + \pi), \\w''(t) &= y''(t + \pi)(t + \pi)' = y''(t + \pi).\end{aligned}$$

Thus, replacing  $t$  by  $t + \pi$  in the given equation yields

$$w'' + w = t + \pi$$

with the initial conditions  $w(0) = y(\pi) = 0$ ,  $w'(0) = y'(\pi) = 0$ .

## Chapter 7

Applying the Laplace transform to both sides of this equation and using Theorem 5 in Section 7.3 to express  $\mathcal{L}\{w''\}$  in terms of  $W := \mathcal{L}\{w\}$ , we obtain

$$\begin{aligned} s^2W + W &= \frac{1}{s^2} + \frac{\pi}{s} \\ \Rightarrow W &= \frac{1}{s^2 + 1} \left( \frac{1}{s^2} + \frac{\pi}{s} \right) = \frac{1 + \pi s}{s^2(s^2 + 1)} = \frac{1}{s^2} + \frac{\pi}{s} - \frac{\pi s}{s^2 + 1} - \frac{1}{s^2 + 1}. \end{aligned}$$

Taking now the inverse Laplace transform and using its linearity and Table 7.1 from Section 7.2 yields

$$w(t) = \mathcal{L}^{-1} \left\{ \frac{1}{s^2} + \frac{\pi}{s} - \frac{\pi s}{s^2 + 1} - \frac{1}{s^2 + 1} \right\} (t) = t + \pi - \pi \cos t - \sin t.$$

Shifting the argument back, we finally get

$$y(t) = w(t - \pi) = (t - \pi) + \pi - \pi \cos(t - \pi) - \sin(t - \pi) = t + \pi \cos t + \sin t.$$

- 16.** Applying the Laplace transform to both sides of the given equation and using Theorem 5 in Section 7.3 to express  $\mathcal{L}\{y''\}$  in terms of  $Y$ , we obtain

$$\begin{aligned} (s^2Y + 1) + 6Y &= \frac{2}{s^3} - \frac{1}{s} \\ \Rightarrow Y &= \frac{1}{s^2 + 6} \left( -1 + \frac{2}{s^3} - \frac{1}{s} \right) = \frac{-s^3 - s^2 + 2}{s^3(s^2 + 6)}. \end{aligned}$$

- 18.** Applying the Laplace transform to both sides of the given equation and using Theorem 5 in Section 7.3 to express  $\mathcal{L}\{y''\}$  and  $\mathcal{L}\{y'\}$  in terms of  $Y$ , we obtain

$$\begin{aligned} (s^2Y - s - 3) - 2(sY - 1) - Y &= \frac{1}{s - 2} - \frac{1}{s - 1} = \frac{1}{(s - 1)(s - 2)} \\ \Rightarrow Y &= \frac{1}{s^2 - 2s - 1} \left[ s + 1 + \frac{1}{(s - 1)(s - 2)} \right] = \frac{s^3 - 2s^2 - s + 3}{(s - 1)(s - 2)(s^2 - 2s - 1)}. \end{aligned}$$

- 20.** Applying the Laplace transform to both sides of the given equation and using Theorem 5 in Section 7.3 to express  $\mathcal{L}\{y''\}$  in terms of  $Y$ , we obtain

$$s^2Y + 3Y = \frac{3!}{s^4} = \frac{6}{s^4} \quad \Rightarrow \quad Y = \frac{6}{s^4(s^2 + 3)}.$$

- 22.** Applying the Laplace transform to both sides of the given equation and using Theorem 5 in Section 7.3 to express  $\mathcal{L}\{y''\}$  and  $\mathcal{L}\{y'\}$  in terms of  $Y$ , we obtain

$$(s^2Y - 2s + 1) - 6(sY - 2) + 5Y = \frac{1}{(s - 1)^2}.$$

Solving for  $Y(s)$  yields

$$\begin{aligned} Y(s) &= \frac{1}{s^2 - 6s + 5} \left[ 2s - 13 + \frac{1}{(s-1)^2} \right] \\ &= \frac{2s^3 - 17s^2 + 28s - 12}{(s-1)^2(s^2 - 6s + 5)} = \frac{2s^3 - 17s^2 + 28s - 12}{(s-1)^3(s-5)}. \end{aligned}$$

24. Let us find the Laplace transform of  $g(t)$ . (In Section 7.6 we will find a simple way to get the Laplace transform of piecewise defined functions using the unit step function  $u(t)$ , but here we should follow the definition of the Laplace transform given in Section 7.2.)

$$\begin{aligned} \mathcal{L}\{g(t)\}(s) &= \int_0^{\infty} e^{-st} g(t) dt = \int_0^3 e^{-st} dt + \int_3^{\infty} te^{-st} dt \\ &= -\frac{e^{-st}}{s} \Big|_{t=0}^3 - \frac{te^{-st}}{s} \Big|_{t=3}^{\infty} + \frac{1}{s} \int_3^{\infty} e^{-st} dt = \frac{1 - e^{-3s}}{s} + \frac{3e^{-3s}}{s} - \frac{e^{-st}}{s^2} \Big|_{t=3}^{\infty} \\ &= \frac{1 + 2e^{-3s}}{s} + \frac{e^{-3s}}{s^2} = \frac{s + 2se^{-3s} + e^{-3s}}{s^2}. \end{aligned}$$

Applying the Laplace transform to both sides of the given equation and using Theorem 5 in Section 7.3 to express  $\mathcal{L}\{y''\}$  in terms of  $Y$ , we obtain

$$(s^2Y - s - 2) - Y = \frac{s + 2se^{-3s} + e^{-3s}}{s^2}.$$

Solving for  $Y(s)$  yields

$$Y(s) = \frac{1}{s^2 - 1} \left( s + 2 + \frac{s + 2se^{-3s} + e^{-3s}}{s^2} \right) = \frac{s^3 + 2s^2 + s + 2se^{-3s} + e^{-3s}}{s^3(s-1)(s+1)}.$$

26. Applying the Laplace transform to both sides of the given equation and using Theorem 5 in Section 7.3 to express  $\mathcal{L}\{y'''\}$ ,  $\mathcal{L}\{y''\}$  and  $\mathcal{L}\{y'\}$  in terms of  $Y$ , we obtain

$$(s^3Y - s^2 - 4s + 2) + 4(s^2Y - s - 4) + (sY - 1) + Y = -\frac{12}{s}.$$

Solving for  $Y(s)$  yields

$$\begin{aligned} Y(s) &= \frac{1}{s^3 + 4s^2 + s - 6} \left( s^2 + 8s + 15 - \frac{12}{s} \right) \\ &= \frac{s^3 + 8s^2 + 15s - 12}{s(s^3 + 4s^2 + s - 6)} = \frac{s^3 + 8s^2 + 15s - 12}{s(s-1)(s+2)(s+3)} \\ &= \frac{1}{s-1} + \frac{1}{s+3} - \frac{3}{s+2} + \frac{2}{s}. \end{aligned}$$

Taking now the inverse Laplace transform leads to the solution

$$y(t) = e^t + e^{-3t} - 3e^{-2t} + 2.$$



## Chapter 7

- 28.** Applying the Laplace transform to both sides of the given equation and using Theorem 5 in Section 7.3 to express  $\mathcal{L}\{y'''\}$ ,  $\mathcal{L}\{y''\}$  and  $\mathcal{L}\{y'\}$  in terms of  $Y$ , we obtain

$$(s^3Y - 2s + 4) + (s^2Y - 2) + 3(sY) - 5Y = -\frac{16}{s+1}.$$

Solving for  $Y(s)$  yields

$$\begin{aligned} Y(s) &= \frac{1}{s^3 + s^2 + 3s - 5} \left( 2s - 2 + \frac{16}{s+1} \right) \\ &= \frac{2s^2 + 14}{(s+1)(s^3 + s^2 + 3s - 5)} = \frac{2s^2 + 14}{(s+1)(s-1)[(s+1)^2 + 2^2]} \\ &= -\frac{2}{s+1} + \frac{1}{s-1} + \frac{s+1}{(s+1)^2 + 2^2}. \end{aligned}$$

Taking now the inverse Laplace transform we get

$$y(t) = -2e^{-t} + e^t + e^{-t} \cos 2t.$$

- 30.** Using the initial conditions,  $y(0) = a$  and  $y'(0) = b$ , and the formula (4) of Section 7.3, we conclude that

$$\begin{aligned} \mathcal{L}\{y'\}(s) &= sY(s) - y(0) = sY(s) - a, \\ \mathcal{L}\{y''\}(s) &= s^2Y(s) - sy(0) - y'(0) = s^2Y(s) - as - b. \end{aligned} \tag{7.8}$$

Applying the Laplace transform to the given equation yields

$$\begin{aligned} [s^2Y(s) - as - b] + 6[sY(s) - a] + 5Y(s) &= \mathcal{L}\{t\}(s) = \frac{1}{s^2} \\ \Rightarrow (s^2 + 6s + 5)Y(s) &= as + b + 6a + \frac{1}{s^2} = \frac{as^3 + (6a+b)s^2 + 1}{s^2} \\ \Rightarrow Y(s) &= \frac{as^3 + (6a+b)s^2 + 1}{s^2(s^2 + 6s + 5)} \\ &= \frac{as^3 + (6a+b)s^2 + 1}{s^2(s+1)(s+5)} = \frac{A}{s^2} + \frac{B}{s} + \frac{C}{s+1} + \frac{D}{s+5}. \end{aligned}$$

Solving for  $A$ ,  $B$ ,  $C$ , and  $D$ , we find that

$$A = \frac{1}{5}, \quad B = -\frac{6}{25}, \quad C = \frac{5a+b+1}{4}, \quad D = -\frac{25a+25b+1}{100}.$$

Hence,

$$\begin{aligned} Y(s) &= \left(\frac{1}{5}\right) \frac{1}{s^2} - \left(\frac{6}{25}\right) \frac{1}{s} + \left(\frac{5a+b+1}{4}\right) \frac{1}{s+1} - \left(\frac{25a+25b+1}{100}\right) \frac{1}{s+5} \\ \Rightarrow y(t) &= \frac{t}{5} - \frac{6}{25} + \frac{5a+b+1}{4} e^{-t} - \frac{25a+25b+1}{100} e^{-5t}. \end{aligned}$$

32. Applying the Laplace transform to both sides the given equation yields

$$\begin{aligned} [s^2Y(s) - as - b] - 5[sY(s) - a] + 6Y(s) &= \mathcal{L}\{-6te^{2t}\}(s) = -\frac{6}{(s-2)^2} \\ \Rightarrow (s^2 - 5s + 6)Y(s) &= as + b - 5a - \frac{6}{(s-2)^2} \\ &= \frac{as^3 + (b-9a)s^2 + (24a-4b)s + (4b-20a-6)}{(s-2)^2} \\ \Rightarrow Y(s) &= \frac{as^3 + (b-9a)s^2 + (24a-4b)s + (4b-20a-6)}{(s-2)^2(s^2-5s+6)} \\ &= \frac{as^3 + (b-9a)s^2 + (24a-4b)s + (4b-20a-6)}{(s-2)^3(s-3)} \\ &= \frac{A}{(s-2)^3} + \frac{B}{(s-2)^2} + \frac{C}{s-2} + \frac{D}{s-3}. \end{aligned}$$

(For the Laplace transforms of  $y'$  and  $y''$  we have used equations (7.8).) Solving for  $A$ ,  $B$ ,  $C$ , and  $D$ , we find that

$$A = 6, \quad B = 6, \quad C = 3a - b + 6, \quad D = b - 2a - 6.$$

Hence,

$$\begin{aligned} Y(s) &= \frac{6}{(s-2)^3} + \frac{6}{(s-2)^2} + \frac{3a-b+6}{s-2} + \frac{b-2a-6}{s-3} \\ \Rightarrow y(t) &= 3t^2e^{2t} + 6te^{2t} + (3a-b+6)e^{2t} + (b-2a-6)e^{3t}. \end{aligned}$$

34. By Theorem 6 in Section 7.3,

$$\mathcal{L}\{t^2y''(t)\}(s) = (-1)^2 \frac{d^2}{ds^2} [\mathcal{L}\{y''(t)\}(s)] = \frac{d^2}{ds^2} [\mathcal{L}\{y''(t)\}(s)]. \quad (7.9)$$

Theorem 5 in Section 7.3 says that

$$\mathcal{L}\{y''(t)\}(s) = s^2Y(s) - y(0)s - y'(0).$$

Substituting this equation into (7.9) yields

$$\begin{aligned} \mathcal{L}\{t^2y'(t)\}(s) &= \frac{d^2}{ds^2} [s^2Y(s) - y(0)s - y'(0)] = \frac{d^2}{ds^2} [s^2Y(s)] \\ &= \frac{d}{ds} [s^2Y'(s) + 2sY(s)] = s^2Y''(s) + 4sY'(s) + 2Y(s). \end{aligned}$$

36. We apply the Laplace transform to the given equation and obtain

$$\mathcal{L}\{ty''\}(s) - \mathcal{L}\{ty'\}(s) + \mathcal{L}\{y\}(s) = \mathcal{L}\{2\}(s) = \frac{2}{s}. \quad (7.10)$$

## Chapter 7

Using Theorem 5 in Section 7.3 and the initial conditions, we express  $\mathcal{L}\{y''\}$  and  $\mathcal{L}\{y'\}$  in terms of  $Y$ .

$$\begin{aligned}\mathcal{L}\{y'\}(s) &= sY(s) - y(0) = sY(s) - 2, \\ \mathcal{L}\{y''\}(s) &= s^2Y(s) - sy(0) - y'(0) = s^2Y(s) - 2s + 1.\end{aligned}$$

We now involve Theorem 6 in Section 7.3 to get

$$\begin{aligned}\mathcal{L}\{ty'\}(s) &= -\frac{d}{ds}[\mathcal{L}\{y'\}(s)] = -\frac{d}{ds}[sY(s) - 2] = -sY'(s) - Y(s), \\ \mathcal{L}\{ty''\}(s) &= -\frac{d}{ds}[\mathcal{L}\{y''\}(s)] = -\frac{d}{ds}[s^2Y(s) - 2s + 1] = -s^2Y'(s) - 2sY(s) + 2.\end{aligned}\tag{7.11}$$

Substituting these equations into (7.10), we obtain

$$\begin{aligned}(-s^2Y' - 2sY + 2) - (-sY' - Y) + Y &= \frac{2}{s} \\ \Rightarrow s(1-s)Y' + 2(1-s)Y &= \frac{2(1-s)}{s} \\ \Rightarrow Y' + \frac{2}{s}Y(s) &= \frac{2}{s^2}.\end{aligned}$$

The integrating factor of this first order linear differential equation is

$$\mu(s) = \exp\left(\int \frac{2}{s} ds\right) = e^{2\ln|s|} = s^2.$$

Hence,

$$Y(s) = \frac{1}{\mu(s)} \int \mu(s) \left(\frac{2}{s^2}\right) ds = \frac{1}{s^2} \int 2 ds = \frac{2}{s} + \frac{C}{s^2},$$

where  $C$  is an arbitrary constant. Therefore,

$$y(t) = \mathcal{L}^{-1}\{Y\}(t) = \mathcal{L}^{-1}\left\{\frac{2}{s} + \frac{C}{s^2}\right\}(t) = 2 + Ct.$$

From the initial condition  $y'(0) = -1$  we find that  $C = -1$  so that the solution to the given initial value problem is  $y(t) = 2 - t$ ,

**38.** Taking the Laplace transform of both sides of  $y'' + ty' - y = 0$ , we conclude that

$$\mathcal{L}\{y''\}(s) + \mathcal{L}\{ty'\}(s) - \mathcal{L}\{y\}(s) = 0.$$

Since, similarly to (7.10),

$$\mathcal{L}\{ty'\}(s) = -sY'(s) - Y(s),$$

we get

$$\begin{aligned} (s^2Y - 3) + (-sY' - Y) - Y &= 0 \\ \Rightarrow -sY' + (s^2 - 2)Y &= 3 \quad \Rightarrow \quad Y' + \left(\frac{2}{s} - s\right)Y = -\frac{3}{s}. \end{aligned}$$

This is a first order linear differential equation in  $Y(s)$ , which can be solved by methods of Section 2.3. Namely, it has an integrating factor

$$\mu(s) = \exp \left[ \int \left( \frac{2}{s} - s \right) ds \right] = \exp \left( 2 \ln |s| - \frac{s^2}{2} \right) = s^2 e^{-s^2/2}.$$

Thus,

$$\begin{aligned} Y(s) &= \frac{1}{\mu(s)} \int \mu(s) \left( -\frac{3}{s} \right) ds = -\frac{3}{s^2 e^{-s^2/2}} \int s e^{-s^2/2} ds \\ &= \frac{3}{s^2 e^{-s^2/2}} \left( e^{-s^2/2} + C \right) = \frac{3}{s^2} \left( 1 + C e^{s^2/2} \right). \end{aligned}$$

The constant  $C$  must be zero in order to ensure that  $Y(s) \rightarrow 0$  as  $s \rightarrow \infty$ . Therefore,  $Y(s) = 3/s^2$ , and from Table 7.1 we get

$$y(t) = \mathcal{L}^{-1} \left\{ \frac{3}{s^2} \right\} (t) = 3t.$$

- 40.** This additional assumption makes the total fed back torque to the steering shaft equal to  $-ke(t) - \mu e'(t)$ , where  $k > 0$  and  $\mu > 0$  are proportionality constants. Thus, the Newton's second law

$$(\text{moment of inertia}) \times (\text{angular acceleration}) = \text{total torque}$$

yields

$$Iy''(t) = -ke(t) - \mu e'(t). \quad (7.12)$$

Since

$$y(t) = e(t) + g(t) = e(t) + a, \quad y'(t) = e'(t), \quad \text{and} \quad y''(t) = e''(t),$$

the equation (7.12) becomes

$$Ie'' + \mu e' + ke = 0 \quad (7.13)$$

with the initial conditions  $e(0) = y(0) - a = -a$ ,  $e'(0) = y'(0) = 0$ .

Let  $E = E(s) := \mathcal{L}\{e(t)\}(s)$ . Taking the Laplace transform of (7.13), we obtain

$$I(s^2E + as) + \mu(sE + a) + kE = 0 \quad \Rightarrow \quad E = -\frac{a(Is + \mu)}{Is^2 + \mu s + k} = -\frac{a(s + \mu/I)}{s^2 + (\mu/I)s + (k/I)}.$$

## Chapter 7

Assuming a mild damping (that is,  $\mu < 2\sqrt{Ik}$ ), we have  $(\mu/I)^2 - (4k/I) < 0$  so that the quadratic  $s^2 + (\mu/I)s + (k/I)$  is irreducible and, therefore,

$$\begin{aligned} E &= -a \left\{ \frac{s + \mu/I}{[s + \mu/(2I)]^2 + [(k/I) - \mu^2/(4I^2)]} \right\} \\ &= -a \left\{ \frac{s + \mu/(2I)}{[s + \mu/(2I)]^2 + [(k/I) - \mu^2/(4I^2)]} \right. \\ &\quad \left. + \frac{\mu/(2I)}{\sqrt{(k/I) - \mu^2/(4I^2)}} \cdot \frac{\sqrt{(k/I) - \mu^2/(4I^2)}}{[s + \mu/(2I)]^2 + [(k/I) - \mu^2/(4I^2)]} \right\}. \end{aligned}$$

Taking the inverse Laplace transform and simplifying yields

$$e(t) = -ae^{-\mu t/(2I)} \left[ \cos \left( \frac{\sqrt{4Ik - \mu^2}}{2I} t \right) + \frac{\mu}{\sqrt{4Ik - \mu^2}} \sin \left( \frac{\sqrt{4Ik - \mu^2}}{2I} t \right) \right].$$

### EXERCISES 7.6: Transforms of Discontinuous and Periodic Functions

2. To find the Laplace transform of  $g(t) = u(t-1) - u(t-4)$ , we apply the linearity of the Laplace transform and formula (4) of the text. This yields

$$\mathcal{L}\{u(t-1) - u(t-4)\}(s) = \frac{e^{-s}}{s} - \frac{e^{-4s}}{s} = \frac{e^{-s} - e^{-4s}}{s}.$$

The graph of  $g(t)$  is shown in Fig. 7-F, page 264.

4. The graph of the function  $y(t) = tu(t-1)$  is shown in Fig. 7-G on page 265. For this function, formula (8) is more convenient. To apply the shifting property, we observe that  $g(t) = t$  and  $a = 1$ . Hence,

$$g(t+a) = g(t+1) = t+1.$$

Now the Laplace transform of  $g(t+1)$  is

$$\mathcal{L}\{t+1\}(s) = \frac{1}{s^2} + \frac{1}{s}.$$

Hence, by formula (8), we have

$$\mathcal{L}\{tu(t-1)\}(s) = e^{-s}\mathcal{L}\{g(t+1)\}(s) = e^{-s} \left( \frac{1}{s^2} + \frac{1}{s} \right) = \frac{e^{-s}(s+1)}{s^2}.$$

6. The function  $g(t)$  equals zero until  $t$  reaches 2, at which point  $g(t)$  jumps to  $t+1$ . We can express this jump by  $(t+1)u(t-2)$ . Hence,

$$g(t) = (t+1)u(t-2)$$

and, by formula (8),

$$\mathcal{L}\{g(t)\}(s) = e^{-2s}\mathcal{L}\{u[(t+1)+2]\}(s) = e^{-2s}\left(\frac{1}{s^2} + \frac{3}{s}\right) = \frac{e^{-2s}(3s+1)}{s^2}.$$

8. Observe from the graph that  $g(t)$  is given by

$$\begin{cases} 0, & t < \pi/2, \\ \sin t, & t > \pi/2. \end{cases}$$

The function  $g(t)$  equals zero until  $t$  reaches the point  $\pi/2$ , at which  $g(t)$  jumps to the function  $\sin t$ . We can express this jump by  $(\sin t)u(t - 1)$ . Hence

$$g(t) = (\sin t)u\left(t - \frac{\pi}{2}\right).$$

Taking the Laplace transform of both sides and using formula (8), we find that the Laplace transform of the function  $g(t)$  is given by

$$\begin{aligned} \mathcal{L}\{g(t)\}(s) &= \mathcal{L}\left\{(\sin t)u\left(t - \frac{\pi}{2}\right)\right\}(s) \\ &= e^{-\pi s/2}\mathcal{L}\left\{\sin\left(t + \frac{\pi}{2}\right)\right\}(s) = e^{-\pi s/2}\mathcal{L}\{\cos t\}(s) = \frac{e^{-\pi s/2}s}{s^2 + 1}. \end{aligned}$$

10. Observe from the graph that  $g(t)$  is given by

$$g(t) = \begin{cases} 0, & t < 1, \\ (t-1)^2, & t > 1. \end{cases} = (t-1)^2u(t-1).$$

Thus, by formula (5), we find that

$$\mathcal{L}\{g(t)\}(s) = \mathcal{L}\{(t-1)^2u(t-1)\}(s) = e^{-s}\mathcal{L}\{t^2\}(s) = \frac{2e^{-s}}{s^3}.$$

12. We use formula (6) of the text with  $a = 3$  and  $F(s) = 1/s^2$ . Since

$$f(t) = \mathcal{L}^{-1}\{F(s)\}(t) = \mathcal{L}^{-1}\left\{\frac{1}{s^2}\right\}(t) = t,$$

we get

$$\mathcal{L}^{-1}\left\{\frac{e^{-3s}}{s^2}\right\}(t) = f(t-3)u(t-3) = (t-3)u(t-3).$$

14. Here,  $F(s) = 1/(s^2 + 9)$  so that  $f(t) = \mathcal{L}^{-1}\{F(s)\}(t) = (\sin 3t)/3$ . Thus, applying Theorem 8 we get

$$\mathcal{L}^{-1}\left\{\frac{e^{-3s}}{s^2 + 9}\right\}(t) = f(t-3)u(t-3) = \frac{\sin(3t-9)}{3}u(t-3).$$

## Chapter 7

**16.** We apply formula (6) (Theorem 8) with  $F(s) = 1/(s^2 + 4)$  and  $a = 1$ .

$$\mathcal{L}^{-1} \left\{ \frac{e^{-s}}{s^2 + 4} \right\} (t) = \mathcal{L}^{-1} \left\{ \frac{1}{s^2 + 4} \right\} (t-1)u(t-1) = \frac{\sin(2t-2)}{2} u(t-1) ..$$

**18.** By partial fractions decomposition,

$$\frac{3s^2 - s + 2}{(s-1)(s^2+1)} = -\frac{2}{s-1} + \frac{s}{s^2+1}$$

so that

$$\begin{aligned} \mathcal{L}^{-1} \left\{ \frac{e^{-s}(3s^2 - s + 2)}{(s-1)(s^2+1)} \right\} (t) &= \mathcal{L}^{-1} \left\{ \frac{2e^{-s}}{s-1} \right\} (t) + \mathcal{L}^{-1} \left\{ \frac{e^{-s}s}{s^2+1} \right\} (t) \\ &= \left[ 2\mathcal{L}^{-1} \left\{ \frac{1}{s-1} \right\} (t-1) + \mathcal{L}^{-1} \left\{ \frac{s}{s^2+1} \right\} (t-1) \right] u(t-1) \\ &= [2e^{t-1} + \cos(t-1)] u(t-1). \end{aligned}$$

**20.** In this problem, we apply methods of Section 7.5 of solving initial value problems using the Laplace transform. Taking the Laplace transform of both sides of the given equation and using the linear property of the Laplace transform, we get

$$\mathcal{L} \{I'' + 4I\} (s) = \mathcal{L} \{I''\} (s) + 4\mathcal{L} \{I\} (s) = \mathcal{L} \{g(t)\} (s). \quad (7.14)$$

Let us denote  $\mathbf{I}(s) := \mathcal{L} \{I\} (s)$ . By Theorem 5, Section 7.3,

$$\mathcal{L} \{I''\} (s) = s^2\mathbf{I}(s) - sI(0) - I'(0) = s^2\mathbf{I}(s) - s - 3.$$

Thus,

$$\mathcal{L} \{I'' + 4I\} (s) = (s^2\mathbf{I}(s) - s - 3) + 4\mathbf{I}(s) = (s^2 + 4)\mathbf{I}(s) - (s + 3). \quad (7.15)$$

To find the Laplace transform of  $g(t)$ , we express this function using the unit step function  $u(t)$ . Since  $g(t)$  identically equals to  $3 \sin t$  for  $0 < t < 2\pi$  and jumps to 0 at  $t = 2\pi$ , we can write

$$g(t) = (3 \sin t) [1 - u(t - 2\pi)] = 3 [\sin t - (\sin t)u(t - 2\pi)].$$

Therefore,

$$\mathcal{L} \{g(t)\} (s) = 3 \left[ \frac{1}{s^2 + 1} - \frac{e^{-2\pi s}}{s^2 + 1} \right] = \frac{3(1 - e^{-2\pi s})}{s^2 + 1}$$

Substituting this equation and (7.15) into (7.14) and solving for  $\mathbf{I}(s)$  yields

$$\mathbf{I}(s) = \frac{s}{s^2 + 4} + \frac{3}{s^2 + 4} + \frac{3(1 - e^{-2\pi s})}{(s^2 + 1)(s^2 + 4)}.$$

Since

$$\frac{3}{(s^2 + 1)(s^2 + 4)} = \frac{1}{s^2 + 1} - \frac{1}{s^2 + 4},$$

we obtain

$$\mathbf{I}(s) = \frac{s}{s^2 + 4} + \frac{3}{s^2 + 4} + (1 - e^{-2\pi s}) \left( \frac{1}{s^2 + 1} - \frac{1}{s^2 + 4} \right). \quad (7.16)$$

Applying the inverse Laplace transform to both sides of (7.16) yields

$$\begin{aligned} I(t) &= \cos 2t + \frac{3}{2} \sin 2t + \sin t - \frac{1}{2} \sin 2t - \left[ \sin(t - 2\pi) - \frac{1}{2} \sin 2(t - 2\pi) \right] u(t - 2\pi) \\ &= \sin t + \sin 2t + \cos 2t + \left( \frac{1}{2} \sin 2t - \sin t \right) u(t - 2\pi). \end{aligned}$$

**22.** In the windowed version (11) of  $f(t)$ ,  $f_T(t) = e^t$  and  $T = 1$ . Thus,

$$F_T(s) := \int_0^{\infty} e^{-st} f_T(t) dt = \int_0^1 e^{-st} e^t dt = \int_0^1 e^{(1-s)t} dt = \frac{e^{1-s} - 1}{1 - s}.$$

From Theorem 9, we obtain

$$\mathcal{L}\{f(t)\}(s) = \frac{F_T(s)}{1 - e^{-s}} = \frac{1 - e^{1-s}}{(s - 1)(1 - e^{-s})}.$$

The graph of the function  $y = f(t)$  is given in Fig. **7-H**, page 265.

**24.** We use formula (12) of the text. With the period  $T = 2$ , the windowed version  $f_T(t)$  of  $f(t)$  is

$$f_T(t) = \begin{cases} f(t), & 0 < t < 2, \\ 0, & t > 2 \end{cases} = \begin{cases} t, & 0 < t < 1, \\ 1 - t, & 1 < t < 2, \\ 0, & t > 2. \end{cases}$$

Therefore,

$$F_T(s) = \int_0^{\infty} e^{-st} f_T(t) dt = \int_0^1 e^{-st} t dt + \int_1^2 e^{-st} (1 - t) dt.$$

Integration by parts yields

$$F_T(s) = \frac{1 - 2e^{-s} - se^{-s} + e^{-2s} + se^{-2s}}{s^2}.$$



## Chapter 7

Therefore, by formula (12),

$$\mathcal{L}\{f(t)\}(s) = \frac{F_T(s)}{1 - e^{-sT}} = \frac{1 - 2e^{-s} - se^{-s} + e^{-2s} + se^{-2s}}{s^2(1 - e^{-2s})}.$$

The graph of  $f(t)$  is shown in Fig. 7-I on page 265.

- 26.** Similarly to Example 6 of the text, we conclude that  $f(t)$  is a periodic function with period  $T = a$ , whose windowed version has the form

$$f_T(t) = \frac{t}{a}, \quad 0 < t < a.$$

Thus, we have

$$F_T(s) = \mathcal{L}\{f_T(t)\}(s) = \int_0^a e^{-st}(t/a) dt = \frac{1}{a} \int_0^a te^{-st} dt = \frac{1 - e^{-as} - ase^{-as}}{as^2}.$$

Applying now Theorem 9 yields

$$\mathcal{L}\{f(t)\}(s) = \frac{1 - e^{-as} - ase^{-as}}{as^2(1 - e^{-as})}.$$

- 28.** Observe that  $f(t)$  is periodic with period  $T = 2\pi$  and

$$f_T(t) = \begin{cases} \sin t, & 0 < t < \pi, \\ 0, & \pi < t < 2\pi. \end{cases}$$

By formula (12) of the text we have

$$\begin{aligned} \mathcal{L}\{f(t)\}(s) &= \frac{\mathcal{L}\{f_T(t)\}(s)}{1 - e^{-2\pi s}} = \frac{\int_0^\pi \sin t e^{-st} dt}{1 - e^{-2\pi s}} \\ &= \frac{1 + e^{-\pi s}}{(s^2 + 1)(1 - e^{-2\pi s})} = \frac{1}{(s^2 + 1)(1 - e^{-\pi s})}, \end{aligned}$$

where we have used integration by parts to evaluate the integral. (One can also use the table of integrals in the text.)

- 30.** Applying the Laplace transform to both sides of the given differential equation and using formulas (4), Section 7.3, and (4) in this section, we obtain

$$\mathcal{L}\{w'' + w\}(s) = \mathcal{L}\{w''\}(s) + \mathcal{L}\{w\}(s)$$

$$\begin{aligned}
&= \mathcal{L}\{u(t-2) - u(t-4)\}(s) = \mathcal{L}\{u(t-2)\}(s) - \mathcal{L}\{u(t-4)\}(s) \\
\Rightarrow \quad s^2W(s) - s + W(s) &= \frac{e^{-2s} - e^{-4s}}{s} \quad \Rightarrow \quad W(s) = \frac{s}{s^2+1} + \frac{e^{-2s} - e^{-4s}}{s(s^2+1)} \\
\Rightarrow \quad W(s) &= \frac{s}{s^2+1} + (e^{-2s} - e^{-4s}) \left( \frac{1}{s} - \frac{s}{s^2+1} \right).
\end{aligned}$$

Thus,

$$w(t) = \mathcal{L}^{-1}\{W(s)\}(t) = \cos t + [1 - \cos(t-2)]u(t-2) - [1 - \cos(t-4)]u(t-4).$$

The graph of the solution is shown in Fig. 7-J, page 265.

**32.** We apply the Laplace transform to both sides of the differential equation and get

$$\begin{aligned}
\mathcal{L}\{y''\}(s) + \mathcal{L}\{y\}(s) &= 3[\mathcal{L}\{\sin 2t\}(s) - \mathcal{L}\{(\sin 2t)u(t-2\pi)\}(s)] \\
\Rightarrow [s^2Y(s) - s + 2] + Y(s) &= 3\left[\frac{2}{s^2+4} - e^{-2\pi s}\mathcal{L}\{\sin 2(t+2\pi)\}(s)\right] = \frac{6(1-e^{-2\pi s})}{s^2+4} \\
\Rightarrow Y(s) &= \frac{s-2}{s^2+1} + \frac{6(1-e^{-2\pi s})}{(s^2+1)(s^2+4)} = \frac{s}{s^2+1} - \frac{2}{s^2+4} - \left(\frac{2}{s^2+1} - \frac{2}{s^2+4}\right)e^{-2\pi s}.
\end{aligned}$$

Therefore,

$$\begin{aligned}
y(t) &= \mathcal{L}^{-1}\{Y(s)\}(t) = \mathcal{L}^{-1}\left\{\frac{s}{s^2+1} - \frac{2}{s^2+4} - \left(\frac{2}{s^2+1} - \frac{2}{s^2+4}\right)e^{-2\pi s}\right\}(t) \\
&= \mathcal{L}^{-1}\left\{\frac{s}{s^2+1}\right\}(t) - \mathcal{L}^{-1}\left\{\frac{2}{s^2+4}\right\}(t) - \left[2\mathcal{L}^{-1}\left\{\frac{1}{s^2+1}\right\}(t-2\pi) \right. \\
&\quad \left. - \mathcal{L}^{-1}\left\{\frac{2}{s^2+4}\right\}(t-2\pi)\right]u(t-2\pi) \\
&= \cos t - \sin 2t - 2(\sin t)u(t-2\pi) + (\sin 2t)u(t-2\pi).
\end{aligned}$$

The graph of the solution is shown in Fig. 7-K on page 266.

**34.** By formula (4) of the text and the linearity of the Laplace transform,

$$\mathcal{L}\{u(t-\pi) - u(t-2\pi)\}(s) = \frac{e^{-\pi s} - e^{-2\pi s}}{s}.$$

Thus, taking the Laplace transform of both sides of the given equation and using the initial conditions,  $y(0) = y'(0) = 0$  (see (4) in Section 7.3) gives us

$$[s^2Y(s) + 4]sY(s) + 4Y(s) = \frac{e^{-\pi s} - e^{-2\pi s}}{s},$$

where  $Y(s)$  is the Laplace transform of  $y(t)$ . Solving for  $Y(s)$  yields

$$Y(s) = \frac{e^{-\pi s} - e^{-2\pi s}}{s(s^2 + 4s + 4)} = \frac{e^{-\pi s} - e^{-2\pi s}}{s(s+2)^2}$$

## Chapter 7

$$\begin{aligned}
 &= (e^{-\pi s} - e^{-2\pi s}) \left[ \frac{1}{4s} - \frac{1}{4(s+2)} - \frac{1}{2(s+2)^2} \right] \\
 &= \frac{1}{4} (e^{-\pi s} - e^{-2\pi s}) \left[ \frac{1}{s} - \frac{1}{s+2} - 2 \frac{1}{(s+2)^2} \right].
 \end{aligned}$$

Therefore, by Theorem 8,

$$\begin{aligned}
 y(t) = \mathcal{L}^{-1} \{Y(s)\} (t) &= \frac{1}{4} [1 - e^{-2(t-\pi)} - 2(t-\pi)e^{-2(t-\pi)}] u(t-\pi) \\
 &\quad - \frac{1}{4} [1 - e^{-2(t-2\pi)} - 2(t-2\pi)e^{-2(t-2\pi)}] u(t-2\pi).
 \end{aligned}$$

- 36.** We take the Laplace transform of the both sides of the given equation and use the initial conditions,  $y(0) = 0$  and  $y'(0) = 1$  to obtain

$$\begin{aligned}
 [s^2 Y(s) - 1] + 5sY(s) + 6Y(s) &= \mathcal{L} \{tu(t-2)\} (s) \\
 &= \mathcal{L} \{(t-2)u(t-2)\} (s) + 2\mathcal{L} \{u(t-2)\} (s) \\
 &= \frac{e^{-2s}}{s^2} + 2 \frac{e^{-2s}}{s} = \frac{e^{-2s}(2s+1)}{s^2}
 \end{aligned}$$

Therefore,

$$\begin{aligned}
 (s^2 + 5s + 6) Y(s) &= 1 + \frac{e^{-2s}(2s+1)}{s^2} \\
 \Rightarrow Y(s) &= \frac{1}{(s+2)(s+3)} + \frac{e^{-2s}(2s+1)}{s^2(s+2)(s+3)}.
 \end{aligned}$$

Using partial fractions decomposition yields

$$\begin{aligned}
 Y(s) &= \frac{1}{s+2} - \frac{1}{s+3} + e^{-2s} \left[ \frac{1}{6s^2} + \frac{7}{36s} - \frac{3}{4(s+2)} + \frac{5}{9(s+3)} \right] \\
 \Rightarrow y(t) &= \mathcal{L}^{-1} \left\{ \frac{1}{s+2} - \frac{1}{s+3} + e^{-2s} \left[ \frac{1}{6s^2} + \frac{7}{36s} - \frac{3}{4(s+2)} + \frac{5}{9(s+3)} \right] \right\} (t) \\
 &= e^{-2t} - e^{-3t} + \left[ \frac{7}{36} + \frac{t-2}{6} - \frac{3e^{-2(t-2)}}{4} + \frac{5e^{-3(t-2)}}{9} \right] u(t-2).
 \end{aligned}$$

- 38.** We can express  $g(t)$  using the unit step function as

$$g(t) = 10 + 10u(t-10) - 20u(t-20).$$

Thus, formula (8) of the text yields

$$\mathcal{L} \{g(t)\} (s) = \frac{10}{s} + \frac{10e^{-10s}}{s} - \frac{20e^{-20s}}{s} = \frac{10}{s} (1 + e^{-10s} - 2e^{-20s}).$$

Let  $Y(s) = \mathcal{L}\{y\}(s)$ . Applying the Laplace transform to the given equation and using the initial conditions, we obtain

$$\begin{aligned}\mathcal{L}\{y''\}(s) + 2\mathcal{L}\{y'\}(s) + 10Y(s) &= \mathcal{L}\{g(t)\}(s) \\ \Rightarrow [s^2Y(s) + s] + 2[sY(s) + 1] + 10Y(s) &= \frac{10}{s}(1 + e^{-10s} - 2e^{-20s}) \\ \Rightarrow Y(s) &= -\frac{s+2}{(s+1)^2+9} + \frac{10}{s[(s+1)^2+9]}(1 + e^{-10s} - 2e^{-20s}).\end{aligned}$$

Using partial fractions decomposition, we can write

$$\begin{aligned}Y(s) &= -\frac{s+2}{(s+1)^2+9} + \left[\frac{1}{s} - \frac{s+2}{(s+1)^2+9}\right](1 + e^{-10s} - 2e^{-20s}) \\ &= \frac{1}{s} - \frac{2(s+2)}{(s+1)^2+9} + \left[\frac{1}{s} - \frac{s+2}{(s+1)^2+9}\right](e^{-10s} - 2e^{-20s}) \\ &= \frac{1}{s} - 2\frac{s+1}{(s+1)^2+9} - \frac{2}{3}\frac{3}{(s+1)^2+9} \\ &\quad + \left[\frac{1}{s} - \frac{s+1}{(s+1)^2+9} - \frac{1}{3}\frac{3}{(s+1)^2+9}\right](e^{-10s} - 2e^{-20s}).\end{aligned}$$

Therefore, taking the inverse Laplace transform, we finally obtain

$$\begin{aligned}y(t) &= 1 - 2\cos 3te^{-t} - \frac{2}{3}\sin 3te^{-t} \\ &\quad + \left[1 - e^{-(t-10)}\cos 3(t-10) - \frac{1}{3}e^{-(t-10)}\sin 3(t-10)\right]u(t-10) \\ &\quad - 2\left[1 - e^{-(t-20)}\cos 3(t-20) - \frac{1}{3}e^{-(t-20)}\sin 3(t-20)\right]u(t-20).\end{aligned}$$

40. We can express  $g(t)$  using the unit step function as

$$g(t) = e^{-t} + (1 - e^{-t})u(t-3).$$

Thus, taking the Laplace transform yields

$$\mathcal{L}\{g(t)\}(s) = \frac{1}{s+1} + \left(\frac{1}{s} - \frac{e^{-3}}{s+1}\right)e^{-3s}$$

so that

$$\begin{aligned}\mathcal{L}\{y'' + 3y' + 2y\}(s) &= [s^2Y(s) - 2s + 1] + 3[sY(s) - 2] + 2Y(s) \\ &= \frac{1}{s+1} + \left(\frac{1}{s} - \frac{e^{-3}}{s+1}\right)e^{-3s},\end{aligned}$$

where  $Y(s) = \mathcal{L}\{y\}(s)$ . Solving for  $Y(s)$ , we obtain

$$(s^2 + 3s + 2)Y(s) = 2s + 5 + \frac{1}{s+1} + \left(\frac{1}{s} - \frac{e^{-3}}{s+1}\right)e^{-3s}$$

$$\begin{aligned} &= \frac{2s^2 + 7s + 6}{s + 1} + \left( \frac{1}{s} - \frac{e^{-3}}{s + 1} \right) e^{-3s} \\ \Rightarrow \quad Y(s) &= \frac{2s^2 + 7s + 6}{(s + 1)^2(s + 2)} + \frac{s(1 - e^{-3}) + 1}{s(s + 1)^2(s + 2)} e^{-3s} \\ &= \frac{2}{s + 1} + \frac{1}{(s + 1)^2} + e^{-3s} \left[ \frac{1}{2s} - \frac{e^{-3}}{(s + 1)^2} - \frac{1 - e^{-3}}{s + 1} + \frac{1 - 2e^{-3}}{2(s + 2)} \right]. \end{aligned}$$

Therefore,

$$\begin{aligned} y(t) &= \mathcal{L}^{-1}\{Y(s)\}(t) = 2e^{-t} + te^{-t} \\ &\quad + \left[ \frac{1}{2} - e^{-3}(t - 3)e^{-(t-3)} - (1 - e^{-3})e^{-(t-3)} + \frac{1 - 2e^{-3}}{2}e^{-2(t-3)} \right] u(t - 3) \\ &= 2e^{-t} + te^{-t} + \left[ \frac{1}{2} - e^{-3}(t - 4e^3)e^{-t} + \frac{e^6 - 2e^3}{2}e^{-2t} \right] u(t - 3). \end{aligned}$$

**42. (a)** For  $nT < t < (n + 1)T$ ,

$$u(t - kT) = \begin{cases} 1, & 0 \leq k \leq n \\ 0, & k \geq n + 1. \end{cases}$$

Thus, (18) reduces to

$$\begin{aligned} g(t) &= e^{-\alpha t} + e^{-\alpha(t-T)} + \dots + e^{-\alpha(t-nT)} \\ &= e^{-\alpha t} (1 + e^{\alpha T} + \dots + e^{\alpha nT}) = e^{-\alpha t} \left[ 1 + e^{\alpha T} + (e^{\alpha T})^2 + \dots + (e^{\alpha T})^n \right]. \end{aligned}$$

We can now apply the *Hint* formula with  $x = e^{\alpha T}$  to get the required.

**(b)** Let  $nT < t < (n + 1)T$ . Subtracting  $(n + 1)T$  from this inequality, we conclude that

$$nT - (n + 1)T < t - (n + 1)T =: v < (n + 1)T - (n + 1)T \quad \Rightarrow \quad -T < v < 0.$$

Using the formula from part (a), we get

$$\begin{aligned} g(t) &= e^{-\alpha t} \frac{e^{(n+1)\alpha T} - 1}{e^{\alpha T} - 1} = \frac{e^{-\alpha t} e^{(n+1)\alpha T}}{e^{\alpha T} - 1} - \frac{e^{-\alpha t}}{e^{\alpha T} - 1} \\ &= \frac{e^{-\alpha[t-(n+1)T]}}{e^{\alpha T} - 1} - \frac{e^{-\alpha t}}{e^{\alpha T} - 1} = \frac{e^{-\alpha v}}{e^{\alpha T} - 1} - \frac{e^{-\alpha t}}{e^{\alpha T} - 1}. \end{aligned}$$

**(c)** With  $\alpha = 1$  and  $T = 2$ , we have

$$g(t) = \frac{e^{-v} - e^{-t}}{e^2 - 1}, \quad v = t - 2(n + 1), \quad 2n < t < 2(n + 1).$$

The graph of  $g(t)$  is depicted in Fig. 7–L on page 266.

44. We apply the formula given in Problem 43 with  $\beta = 1$  and  $T = \pi$ .

$$\begin{aligned} g(t) &= \sin t + \sin(t - \pi)u(t - \pi) + \sin(t - 2\pi)u(t - 2\pi) + \cdots \\ &= \sin t [1 - u(t - \pi)] + \sin t [u(t - 2\pi) - u(t - 3\pi)] + \cdots \\ &= \sin t \sum_{k=0}^{\infty} \{u(t - 2k\pi) - u[t - (2k + 1)\pi]\} = \sin t \sum_{k=0}^{\infty} h_k(t), \end{aligned}$$

where the functions

$$h_k(t) := u(t - 2k\pi) - u[t - (2k + 1)\pi] = \begin{cases} 0, & t < 2k\pi \\ 1, & 2k\pi < t < (2k + 1)\pi \\ 0, & t > (2k + 1)\pi, \end{cases} \quad k = 0, 1, \dots$$

Therefore,

$$\sum_{k=0}^{\infty} h_k(t) = \begin{cases} 1, & 2n\pi < t < (2n + 1)\pi \\ 0, & (2n + 1)\pi < t < 2(n + 1)\pi, \end{cases} \quad n = 0, 1, \dots,$$

which is periodic with period  $2\pi$ . Thus,

$$g(t) = \sin t \sum_{k=0}^{\infty} h_k(t) = \begin{cases} \sin t, & 2n\pi < t < (2n + 1)\pi \\ 0, & (2n + 1)\pi < t < 2(n + 1)\pi, \end{cases} \quad n = 0, 1, \dots,$$

is also periodic with period  $2\pi$ .

46. Note that  $f(t)$  is periodic with period  $T = 2a = 2$ . In order to apply the method of Laplace transform to given initial value problem, let us find  $\mathcal{L}\{f\}(s)$  first. Since the period of  $f(t)$  is  $T = 2$  and  $f(t) = 1$  on  $(0, 1)$ , the windowed version of  $f(t)$  is

$$f_T(t) = \begin{cases} 1, & 0 < t < 1, \\ 0, & \text{otherwise,} \end{cases}$$

and so

$$F_T(s) = \int_0^{\infty} e^{-st} f_T(t) dt = \int_0^1 e^{-st} dt = \frac{1 - e^{-s}}{s}.$$

Hence, Theorem 9 yields the following formula for  $\mathcal{L}\{f\}(s)$ :

$$\mathcal{L}\{f\}(s) = \frac{1 - e^{-s}}{s(1 - e^{-2s})} = \frac{1}{s(1 + e^{-s})}.$$

We can now apply the Laplace transform to the given differential equation and obtain

$$\mathcal{L}\{y''\}(s) + 3\mathcal{L}\{y'\}(s) + 2\mathcal{L}\{y\}(s) = (s^2 + 3s + 2)Y(s) = \frac{1}{s(1 + e^{-s})}$$

## Chapter 7

$$\Rightarrow Y(s) = \frac{1}{1+e^{-s}} \frac{1}{s(s+1)(s+2)} = \frac{1}{1+e^{-s}} \left[ \frac{1}{2s} - \frac{1}{s+1} + \frac{1}{2(s+2)} \right].$$

Since

$$\frac{1}{1+e^{-s}} = \sum_{k=0}^{\infty} (-1)^k e^{-ks},$$

similarly to (18) we obtain

$$y(t) = \sum_{k=0}^{\infty} (-1)^k \left[ \frac{1}{2} - e^{-(t-k)} + \frac{1}{2} e^{-2(t-k)} \right] u(t-k).$$

For  $n < t < n+1$ , this yields

$$\begin{aligned} y(t) &= \sum_{k=0}^n (-1)^k \left[ \frac{1}{2} - e^{-(t-k)} + \frac{1}{2} e^{-2(t-k)} \right] \\ &= \frac{1 - (-1)^{n+1}}{4} + e^{-t} \frac{(-1)^{n+1} e^{n+1} - 1}{e+1} - e^{-2t} \frac{(-1)^{n+1} e^{2(n+1)} - 1}{2(e^2+1)}. \end{aligned}$$

48. Since

$$\sin t = \sum_{k=0}^{\infty} \frac{(-1)^k t^{2k+1}}{(2k+1)!} \quad (7.17)$$

and

$$\mathcal{L}\{t^{2k+1}\}(s) = \frac{(2k+1)!}{s^{2k+2}},$$

using the linearity of the Laplace transform we have

$$\mathcal{L}\{\sin t\}(s) = \mathcal{L}\left\{ \sum_{k=0}^{\infty} \frac{(-1)^k t^{2k+1}}{(2k+1)!} \right\}(s) = \sum_{k=0}^{\infty} \frac{(-1)^k (2k+1)! / s^{2k+2}}{(2k+1)!} = \frac{1}{s^2} \sum_{k=0}^{\infty} \left( -\frac{1}{s^2} \right)^k.$$

We can apply now the summation formula for geometric series, that is,

$$1 + x + x^2 + \cdots = \frac{1}{1-x},$$

which is valid for  $|x| < 1$ . Taking  $x = -1/s^2$ ,  $s > 1$ , yields

$$\mathcal{L}\{\sin t\}(s) = \frac{1}{s^2} \cdot \frac{1}{1 - (-1/s^2)} = \frac{1}{s^2 + 1}.$$

50. Recall that the Taylor's series for  $e^x$  about  $x = 0$  is

$$e^x = \sum_{k=0}^{\infty} \frac{x^k}{k!} \quad (7.18)$$

so that

$$e^{-t^2} = \sum_{k=0}^{\infty} \frac{(-1)^k t^{2k}}{k!}$$

Therefore,

$$\mathcal{L}\{e^{-t^2}\}(s) = \sum_{k=0}^{\infty} \frac{(-1)^k}{k!} \mathcal{L}\{t^{2k}\}(s) = \sum_{k=0}^{\infty} \frac{(-1)^k}{k!} \frac{(2k)!}{s^{2k+1}} = \sum_{k=0}^{\infty} \frac{(-1)^k (2k)!}{k!} \left(\frac{1}{s}\right)^{2k+1}.$$

**52.** The given relation is equivalent to

$$\mathcal{L}\{t^{n-1/2}\}(s) = \frac{1 \cdot 3 \cdots (2n-1)\sqrt{\pi}}{2^n} \frac{1}{s^{n+1/2}}. \quad (7.19)$$

From formula (17) of the text,

$$\mathcal{L}\{t^{n-1/2}\}(s) = \frac{\Gamma[(n-1/2)+1]}{s^{(n-1/2)+1}} = \frac{\Gamma(n+1/2)}{s^{n+1/2}}.$$

The recursive formula (16) then yields

$$\begin{aligned} \Gamma\left(n + \frac{1}{2}\right) &= \Gamma\left(\frac{2n-1}{2} + 1\right) = \frac{2n-1}{2} \Gamma\left(\frac{2n-3}{2} + 1\right) = \cdots \\ &= \frac{2n-1}{2} \frac{2n-3}{2} \cdots \frac{1}{2} \Gamma\left(\frac{1}{2}\right) = \frac{(2n-1)(2n-3)\cdots 1}{2^n} \sqrt{\pi}, \end{aligned}$$

and (7.19) follows.

**54.** Since

$$\arctan x = \sum_{n=0}^{\infty} (-1)^n \frac{x^{2n+1}}{2n+1} = x - \frac{x^3}{3} + \frac{x^5}{5} - \cdots,$$

letting  $x = 1/s$ , we obtain

$$\arctan\left(\frac{1}{s}\right) = \frac{1}{s} - \frac{1}{3s^3} + \frac{1}{5s^5} - \cdots.$$

**56.** Substituting  $-1/s$  for  $x$  into the Taylor's series (7.18) yields

$$e^{-1/s} = 1 - \frac{1}{s} + \frac{1}{2!s^2} - \frac{1}{3!s^3} + \cdots + \frac{(-1)^n}{n!s^n} + \cdots.$$

Thus, we have

$$s^{-3/2}e^{-1/s} = \frac{1}{s^{3/2}} - \frac{1}{s^{5/2}} + \frac{1}{2!s^{7/2}} + \cdots + \frac{(-1)^n}{n!s^{n+3/2}} + \cdots = \sum_{n=0}^{\infty} \frac{(-1)^n}{n!s^{n+3/2}}.$$



## Chapter 7

Replacing in Problem 52 of this section  $n$  by  $n + 1$  yields

$$\mathcal{L}^{-1} \left\{ \frac{1}{s^{n+(3/2)}} \right\} (t) = \frac{2^{n+1} t^{n+(1/2)}}{1 \cdot 3 \cdot 5 \cdots (2n+1) \sqrt{\pi}},$$

so that

$$\begin{aligned} \mathcal{L}^{-1} \{ s^{-3/2} e^{-1/s} \} &= \mathcal{L}^{-1} \left\{ \sum_{n=0}^{\infty} \frac{(-1)^n}{n! s^{n+3/2}} \right\} \\ &= \sum_{n=0}^{\infty} \frac{(-1)^n}{n!} \mathcal{L}^{-1} \left\{ \frac{1}{s^{n+(3/2)}} \right\} = \sum_{n=0}^{\infty} \frac{(-1)^n}{n!} \frac{2^{n+1} t^{n+(1/2)}}{1 \cdot 3 \cdot 5 \cdots (2n+1) \sqrt{\pi}}. \end{aligned}$$

Multiplying the numerator and denominator of the  $n$ th term by  $2 \cdot 4 \cdots (2n) = 2^n n!$ , we obtain

$$\begin{aligned} \mathcal{L}^{-1} \{ s^{-3/2} e^{-1/s} \} (t) &= \sum_{n=0}^{\infty} \frac{(-1)^n 2^{n+1} 2^n t^{n+(1/2)}}{(2n+1)! \sqrt{\pi}} = \sum_{n=0}^{\infty} \frac{(-1)^n 2^{2n+1}}{(2n+1)! \sqrt{\pi}} t^{(2n+1)/2} \\ &= \frac{1}{\sqrt{\pi}} \sum_{n=0}^{\infty} \frac{(-1)^n (2\sqrt{t})^{2n+1}}{(2n+1)!} = \frac{1}{\sqrt{\pi}} \sin(2\sqrt{t}). \end{aligned}$$

(See (7.17).)

**58. (a)** Since

$$u(t-a) = \begin{cases} 0, & t < a \\ 1, & t > a, \end{cases}$$

we have

**(i)** for  $t < 0$ ,

$$u(t) - u(t-a) = 0 - 0 = 0;$$

**(ii)** for  $0 < t < a$ ,

$$u(t) - u(t-a) = 1 - 0 = 1;$$

**(iii)** for  $t > a$ ,

$$u(t) - u(t-a) = 1 - 1 = 0.$$

Thus,  $u(t) - u(t-a) = G_a(t)$ .

**(b)** We use now formula (4) from the text to get

$$\begin{aligned} \mathcal{L} \{ G_a \} (s) &= \mathcal{L} \{ u(t) - u(t-a) \} (s) \\ &= \mathcal{L} \{ u(t) \} (s) - \mathcal{L} \{ u(t-a) \} (s) = \frac{1}{s} - \frac{e^{-as}}{s} = \frac{1 - e^{-as}}{s}. \end{aligned}$$

(c) Since

$$G_a(t-b) = u(t-b) - u[(t-b)-a] = u(t-b) - u[t-(a+b)],$$

similarly to part (b) we have

$$\begin{aligned} \mathcal{L}\{G_a(t-b)\}(s) &= \mathcal{L}\{u(t-b) - u[t-(a+b)]\}(s) \\ &= \mathcal{L}\{u(t-b)\}(s) - \mathcal{L}\{u[t-(a+b)]\}(s) \\ &= \frac{e^{-bs}}{s} - \frac{e^{-(a+b)s}}{s} = \frac{e^{-bs} - e^{-(a+b)s}}{s}. \end{aligned}$$

60. Applying the Laplace transform to both sides of the original equation and using its linearity, we obtain

$$\mathcal{L}\{y''\}(s) - \mathcal{L}\{y\}(s) = \mathcal{L}\{G_4(t-3)\}(s). \quad (7.20)$$

Initial conditions,  $y(0) = 1$  and  $y'(0) = -1$ , and Theorem 5 in Section 7.3 imply that

$$\mathcal{L}\{y''\}(s) = s^2\mathcal{L}\{y\}(s) - sy(0) - y'(0) = s^2\mathcal{L}\{y\}(s) - s + 1.$$

In the right-hand side of (7.20), we can apply the result of Problem 58(c) with  $a = 4$  and  $b = 3$  to get

$$\mathcal{L}\{G_4(t-3)\}(s) = \frac{e^{-3s} - e^{-7s}}{s}.$$

Thus, (7.20) becomes

$$\begin{aligned} [s^2\mathcal{L}\{y\}(s) - s + 1] - \mathcal{L}\{y\}(s) &= \frac{e^{-3s} - e^{-7s}}{s} \\ \Rightarrow \mathcal{L}\{y\}(s) &= \frac{1}{s+1} + \frac{e^{-3s} - e^{-7s}}{s(s^2-1)}. \end{aligned}$$

Substituting partial fractions decomposition

$$\frac{1}{s(s^2-1)} = \frac{(1/2)}{s-1} + \frac{(1/2)}{s+1} - \frac{1}{s}$$

yields

$$\mathcal{L}\{y\}(s) = \frac{1}{s+1} + e^{-3s} \left[ \frac{(1/2)}{s-1} + \frac{(1/2)}{s+1} - \frac{1}{s} \right] - e^{-7s} \left[ \frac{(1/2)}{s-1} + \frac{(1/2)}{s+1} - \frac{1}{s} \right].$$

Since

$$\mathcal{L}^{-1} \left\{ \frac{1/2}{s-1} + \frac{1/2}{s+1} - \frac{1}{s} \right\} (t) = \frac{e^t + e^{-t} - 2}{2},$$

## Chapter 7

formula (6) of the text gives us

$$\mathcal{L}^{-1} \left\{ e^{-3s} \left[ \frac{(1/2)}{s-1} + \frac{(1/2)}{s+1} - \frac{1}{s} \right] \right\} (t) = \frac{e^{t-3} + e^{3-t} - 2}{2} u(t-3),$$

$$\mathcal{L}^{-1} \left\{ e^{-7s} \left[ \frac{(1/2)}{s-1} + \frac{(1/2)}{s+1} - \frac{1}{s} \right] \right\} (t) = \frac{e^{t-7} + e^{7-t} - 2}{2} u(t-7),$$

so that

$$y(t) = e^{-t} + \frac{e^{t-3} + e^{3-t} - 2}{2} u(t-3) - \frac{e^{t-7} + e^{7-t} - 2}{2} u(t-7).$$

- 62.** In this problem, we use the method of solving “mixing problems” discussed in Section 3.2. So, let  $x(t)$  denote the mass of salt in the tank at time  $t$  with  $t = 0$  denoting the moment when mixing started. Thus, using the formula

$$\text{mass} = \text{volume} \times \text{concentration},$$

we have the initial condition

$$x(0) = 500 \text{ (L)} \times 0.2 \text{ (kg/L)} = 100 \text{ (kg)}.$$

For the rate of change of  $x(t)$ , that is,  $x'(t)$ , we use then relation

$$x'(t) = \text{input rate} - \text{output rate}. \quad (7.21)$$

While the output rate (through the exit valve  $C$ ) can be computed as

$$\text{output rate} = \frac{x(t)}{500} \text{ (kg/L)} \times 12 \text{ (L/min)} = \frac{3x(t)}{125} \text{ (kg/min)}$$

for all  $t$ , the input rate has different formulas for different time intervals. Namely,

$$\begin{aligned} 0 < t < 10 \text{ (valve } B) : & \quad \text{input rate} = 12 \text{ (L/min)} \times 0.6 \text{ (kg/L)} = 7.2 \text{ (kg/min)} \\ 10 < t < 20 \text{ (valve } A) : & \quad \text{input rate} = 12 \text{ (L/min)} \times 0.4 \text{ (kg/L)} = 4.8 \text{ (kg/min)}; \\ t > 20 \text{ (valve } B) : & \quad \text{input rate} = 12 \text{ (L/min)} \times 0.6 \text{ (kg/L)} = 7.2 \text{ (kg/min)}. \end{aligned}$$

In other words, the input rate is a function of  $t$ , which can be written as

$$\text{input rate} = g(t) = \begin{cases} 7.2, & 0 < t < 10 \\ 4.8, & 10 < t < 20 \\ 7.2, & t > 20. \end{cases}$$

Using the unit step function, we can express

$$g(t) = 7.2 - 2.4u(t - 10) + 2.4u(t - 20) \text{ (kg/min)}.$$

Therefore, (7.21) becomes

$$x'(t) = g(t) - \frac{3x(t)}{125} \quad \Rightarrow \quad x'(t) + \frac{3}{125}x(t) = 7.2 - 2.4u(t - 10) + 2.4u(t - 20)$$

with the initial condition  $x(0) = 100$ . Taking the Laplace transform of both sides yields

$$\begin{aligned} \mathcal{L}\{x'\}(s) + \frac{3}{125}\mathcal{L}\{x\}(s) &= \mathcal{L}\{7.2 - 2.4u(t - 10) + 2.4u(t - 20)\}(s) \\ \Rightarrow [sX(s) - 100] + \frac{3}{125}X(s) &= \frac{7.2}{s} - \frac{2.4e^{-10s}}{s} + \frac{2.4e^{-20s}}{s} \\ \Rightarrow X(s) &= \frac{100s + 7.2}{s[s + (3/125)]} - \frac{2.4e^{-10s}}{s[s + (3/125)]} + \frac{2.4e^{-20s}}{s[s + (3/125)]}. \end{aligned} \quad (7.22)$$

Since

$$\begin{aligned} \frac{100s + 7.2}{s[s + (3/125)]} &= 100 \left[ \frac{3}{s} - \frac{2}{s + (3/125)} \right], \\ \frac{2.4}{s[s + (3/125)]} &= 100 \left[ \frac{1}{s} - \frac{1}{s + (3/125)} \right], \end{aligned}$$

applying the inverse Laplace transform in (7.22), we get

$$x(t) = 100 \left\{ [3 - 2e^{-3t/125}] - [1 - e^{-3(t-10)/125}]u(t - 10) + [1 - e^{-3(t-20)/125}]u(t - 20) \right\}.$$

Finally, dividing by the volume of the solution in the tank, which constantly equals to 500 L, we conclude that the concentration  $C$  is given by

$$C = [0.6 - 0.4e^{-3t/125}] - 0.2 [1 - e^{-3(t-10)/125}]u(t - 10) + 0.2 [1 - e^{-3(t-20)/125}]u(t - 20).$$

### EXERCISES 7.7: Convolution

2. Let  $Y(s) := \mathcal{L}\{y\}(s)$ ,  $G(s) := \mathcal{L}\{g\}(s)$ . Taking the Laplace transform of both sides of the given differential equation and using the linear property of the Laplace transform, we obtain

$$\begin{aligned} [s^2Y(s) - s] + 9Y(s) &= G(s) \quad \Rightarrow \quad (s^2 + 9)Y(s) = s + G(s) \\ \Rightarrow Y(s) &= \frac{s}{s^2 + 3^2} + \frac{G(s)}{s^2 + 3^2}. \end{aligned}$$

## Chapter 7

Taking now the inverse Laplace transform, we obtain

$$y(t) = \mathcal{L}^{-1} \left\{ \frac{s}{s^2 + 3^2} \right\} (t) + \frac{1}{3} \mathcal{L}^{-1} \left\{ \frac{3}{s^2 + 3^2} G(s) \right\} (t) = \cos 3t + \frac{1}{3} \sin(3t) * g(t).$$

Thus,

$$y(t) = \cos 3t + \frac{1}{3} \int_0^t \sin [3(t-v)] g(v) dv.$$

4. Let  $Y(s) := \mathcal{L}\{y\}(s)$ ,  $G(s) := \mathcal{L}\{g\}(s)$ . Taking the Laplace transform of both sides of the given differential equation and using the linear property of the Laplace transform, we obtain

$$\begin{aligned} [s^2 Y(s) - 1] + Y(s) &= G(s) &\Rightarrow & (s^2 + 1) Y(s) = 1 + G(s) \\ \Rightarrow Y(s) &= \frac{1}{s^2 + 1} + \frac{G(s)}{s^2 + 1}. \end{aligned}$$

Taking now the inverse Laplace transform, we obtain

$$\begin{aligned} y(t) &= \mathcal{L}^{-1} \left\{ \frac{1}{s^2 + 1} \right\} (t) + \mathcal{L}^{-1} \left\{ \frac{1}{s^2 + 1} G(s) \right\} (t) \\ &= \sin t + \sin t * g(t) = \sin t + \int_0^t \sin(t-v) g(v) dv. \end{aligned}$$

6. From Table 7.1, Section 7.2,  $\mathcal{L}^{-1}\{1/(s-a)\}(t) = e^{at}$ . Therefore, using the linearity of the inverse Laplace transform and the convolution theorem, we have

$$\begin{aligned} \mathcal{L}^{-1} \left\{ \frac{1}{(s+1)(s+2)} \right\} (t) &= \mathcal{L}^{-1} \left\{ \frac{1}{s+1} \cdot \frac{1}{s+2} \right\} (t) = e^{-t} * e^{-2t} \\ &= \int_0^t e^{-(t-v)} e^{-2v} dv e^{-t} \int_0^t e^{-v} dv = e^{-t} (1 - e^{-t}) = e^{-t} - e^{-2t}. \end{aligned}$$

8. Since  $1/(s^2 + 4)^2 = (1/4)[2/(s^2 + 2^2)] \cdot [2/(s^2 + 2^2)]$ , the convolution theorem tells us

$$\begin{aligned} \mathcal{L}^{-1} \left\{ \frac{1}{(s^2 + 4)^2} \right\} (t) &= \frac{1}{4} \mathcal{L}^{-1} \left\{ \frac{2}{s^2 + 4} \cdot \frac{2}{s^2 + 4} \right\} (t) \\ &= \frac{1}{4} \sin(2t) * \sin(2t) = \frac{1}{4} \int_0^t \sin [2(t-v)] \sin(2v) dv. \end{aligned}$$

Using the identity  $\sin \alpha \sin \beta = [\cos(\alpha - \beta) - \cos(\alpha + \beta)]/2$ , we get

$$\mathcal{L}^{-1} \left\{ \frac{1}{(s^2 + 4)^2} \right\} (t) = \frac{1}{8} \int_0^t [\cos(2t - 4v) - \cos 2t] dv$$

$$= \frac{1}{8} \left[ \frac{\sin(4v - 2t)}{4} - v \cos 2t \right] \Big|_0^t = \frac{\sin 2t}{16} - \frac{t \cos 2t}{8}.$$

10. We have

$$\begin{aligned} \mathcal{L}^{-1} \left\{ \frac{1}{s^3 (s^2 + 1)} \right\} &= \mathcal{L}^{-1} \left\{ \frac{1}{s^3} \right\} * \mathcal{L}^{-1} \left\{ \frac{1}{s^2 + 1} \right\} = \frac{t^2}{2} * \sin t = \frac{1}{2} \int_0^t (t - v)^2 \sin v \, dv \\ &= \frac{1}{2} \left[ -(v - t)^2 \cos v \Big|_0^t + 2 \int_0^t (v - t) \cos v \, dv \right] \\ &= \frac{1}{2} \left[ t^2 + 2(v - t) \sin v \Big|_0^t - 2 \int_0^t \sin v \, dv \right] = \frac{t^2}{2} + \cos t - 1. \end{aligned}$$

12. By the linearity of the inverse Laplace transform,

$$\mathcal{L}^{-1} \left\{ \frac{s + 1}{(s^2 + 1)^2} \right\} (t) = \mathcal{L}^{-1} \left\{ \frac{s}{(s^2 + 1)^2} \right\} (t) + \mathcal{L}^{-1} \left\{ \frac{1}{(s^2 + 1)^2} \right\} (t).$$

The second term can be evaluated similarly to that in Problem 8. (See also Example 2.)

$$\mathcal{L}^{-1} \left\{ \frac{1}{(s^2 + 1)^2} \right\} (t) = \frac{\sin t - t \cos t}{2}. \quad (7.23)$$

For the first term, we notice that  $s/(s^2 + 1)^2 = [s/(s^2 + 1)] \cdot [1/(s^2 + 1)]$  and apply the convolution theorem.

$$\mathcal{L}^{-1} \left\{ \frac{s}{(s^2 + 1)^2} \right\} (t) = \mathcal{L}^{-1} \left\{ \frac{s}{s^2 + 1} \cdot \frac{1}{s^2 + 1} \right\} (t) = \cos t * \sin t = \int_0^t \cos(t - v) \sin v \, dv.$$

Using the identity  $\sin \alpha \cos \beta = [\sin(\alpha + \beta) + \sin(\alpha - \beta)]/2$ , we get

$$\begin{aligned} \mathcal{L}^{-1} \left\{ \frac{s}{(s^2 + 1)^2} \right\} (t) &= \frac{1}{2} \int_0^t [\sin t + \sin(t - 2v)] \, dv \\ &= \frac{1}{2} \left[ v \sin t + \frac{\cos(t - 2v)}{2} \right] \Big|_{v=0}^{v=t} = \frac{t \sin t}{2}. \end{aligned} \quad (7.24)$$

Combining (7.23) and (7.24) yields

$$\mathcal{L}^{-1} \left\{ \frac{s + 1}{(s^2 + 1)^2} \right\} (t) = \frac{t \sin t}{2} + \frac{\sin t - t \cos t}{2} = \frac{t \sin t + \sin t - t \cos t}{2}.$$

## Chapter 7

14. Note that  $f(t) = e^t * \sin t$ . Hence, by formula (8) of the text,

$$\mathcal{L}\{f(t)\}(s) = \mathcal{L}\{e^t\}(s) \cdot \mathcal{L}\{\sin t\}(s) = \frac{1}{s-1} \cdot \frac{1}{s^2+1} = \frac{1}{(s-1)(s^2+1)}.$$

16. Note that

$$\int_0^t e^{t-v} y(v) dv = e^t * y(t).$$

Let  $Y(s) := \mathcal{L}\{y\}(s)$ . Taking the Laplace transform of the original equation and using Theorem 11, we obtain

$$\begin{aligned} Y(s) + \mathcal{L}\{e^t * y(t)\}(s) &= Y(s) + \frac{1}{s-1} Y(s) = \mathcal{L}\{\sin t\}(s) = \frac{1}{s^2+1} \\ \Rightarrow \left(1 + \frac{1}{s-1}\right) Y(s) &= \frac{1}{s^2+1} \\ \Rightarrow Y(s) &= \frac{s-1}{s(s^2+1)} = \frac{s}{s^2+1} + \frac{1}{s^2+1} - \frac{1}{s} \\ \Rightarrow y(t) &= \mathcal{L}^{-1}\left\{\frac{s}{s^2+1} + \frac{1}{s^2+1} - \frac{1}{s}\right\}(t) = \cos t + \sin t - 1. \end{aligned}$$

18. We use the convolution Theorem 11 to find the Laplace transform of the integral term.

$$\mathcal{L}\left\{\int_0^t (t-v)y(v) dv\right\}(s) = \mathcal{L}\{t * y(t)\}(s) = \mathcal{L}\{t\}(s)\mathcal{L}\{y(t)\}(s) = \frac{Y(s)}{s^2}, \quad (7.25)$$

where  $Y(s)$  denotes the Laplace transform of  $y(t)$ . Thus taking the Laplace transform of both sides of the given equation yields

$$\begin{aligned} Y(s) + \frac{Y(s)}{s^2} &= \frac{2}{s^3} \quad \Rightarrow \quad Y(s) = \frac{2}{s(s^2+1)} = 2\left(\frac{1}{s} - \frac{s}{s^2+1}\right) \\ \Rightarrow y(t) &= \mathcal{L}^{-1}\left\{2\left(\frac{1}{s} - \frac{s}{s^2+1}\right)\right\}(t) = 2(1 - \cos t). \end{aligned}$$

20. The Laplace transform of the integral term is found in Problem 18 (see (7.25)). Since

$$\mathcal{L}\{y'(t)\}(s) = sY(s) - y(0) = sY(s),$$

taking the Laplace transform of both sides of the given equation yields

$$\begin{aligned} sY(s) + \frac{Y(s)}{s^2} &= \frac{s^3+1}{s^2} Y(s) = \mathcal{L}\{t\}(s) = \frac{1}{s^2} \\ \Rightarrow Y(s) &= \frac{1}{s^3+1} = \frac{1}{(s+1)(s^2+s+1)} \end{aligned}$$

$$= \frac{1}{3} \frac{1}{s+1} - \frac{1}{3} \frac{s - (1/2)}{[s - (1/2)]^2 + (\sqrt{3}/2)^2} + \frac{1}{\sqrt{3}} \frac{(\sqrt{3}/2)}{[s - (1/2)]^2 + (\sqrt{3}/2)^2}.$$

Therefore,

$$\begin{aligned} y(t) &= \mathcal{L}^{-1} \left\{ \frac{1}{3} \frac{1}{s+1} - \frac{1}{3} \frac{s - (1/2)}{[s - (1/2)]^2 + (\sqrt{3}/2)^2} + \frac{1}{\sqrt{3}} \frac{(\sqrt{3}/2)}{[s - (1/2)]^2 + (\sqrt{3}/2)^2} \right\} (t) \\ &= \frac{1}{3} e^{-t} - \frac{1}{3} e^{t/2} \cos \left( \frac{\sqrt{3}t}{2} \right) + \frac{1}{\sqrt{3}} e^{t/2} \sin \left( \frac{\sqrt{3}t}{2} \right). \end{aligned}$$

**22.** We rewrite the given integro-differential equation in the form

$$y'(t) - 2e^t * y(t) = t$$

and take the Laplace transform of both sides using Theorem 11.

$$\begin{aligned} [sY(s) - y(0)] - \frac{2}{s-1} Y(s) &= \left( s - \frac{2}{s-1} \right) Y(s) - 2 = \frac{1}{s^2} \\ \Rightarrow Y(s) &= \frac{(2s^2 + 1)(s-1)}{s^2(s+1)(s-2)} = \left( \frac{1}{2} \right) \frac{1}{s^2} - \left( \frac{3}{4} \right) \frac{1}{s} + (2) \frac{1}{s+1} + \left( \frac{3}{4} \right) \frac{1}{s-2}, \end{aligned}$$

where  $Y(s) = \mathcal{L}\{y\}(s)$ . Thus, taking the inverse Laplace transform yields

$$\begin{aligned} y(t) &= \mathcal{L}^{-1} \left\{ \left( \frac{1}{2} \right) \frac{1}{s^2} - \left( \frac{3}{4} \right) \frac{1}{s} + (2) \frac{1}{s+1} + \left( \frac{3}{4} \right) \frac{1}{s-2} \right\} (t) \\ &= \frac{t}{2} - \frac{3}{4} + 2e^{-t} + \frac{3e^{2t}}{4}. \end{aligned}$$

**24.** Taking the Laplace transform of the differential equation, and assuming zero initial conditions, we obtain

$$s^2Y(s) - 9Y(s) = (s^2 - 9)Y(s) = G(s),$$

where  $Y = \mathcal{L}\{y\}$ ,  $G = \mathcal{L}\{g\}$ . Thus, the transfer function

$$H(s) = \frac{Y(s)}{G(s)} = \frac{1}{s^2 - 9}.$$

The impulse response function is then

$$\begin{aligned} h(t) &= \mathcal{L}^{-1}\{H(s)\}(t) = \mathcal{L}^{-1} \left\{ \frac{1}{s^2 - 9} \right\} (t) \\ &= \mathcal{L}^{-1} \left\{ \frac{1}{6} \left( \frac{1}{s-3} - \frac{1}{s+3} \right) \right\} (t) = \frac{e^{3t} - e^{-3t}}{6} = \frac{\sinh 3t}{3}. \end{aligned}$$



## Chapter 7

Next, we find the solution  $y_k(t)$  to the corresponding homogeneous equation that satisfies the initial conditions. Since the characteristic equation,  $r^2 - 9 = 0$ , has roots  $r = \pm 3$ , we have

$$y_k(t) = C_1 e^{3t} + C_2 e^{-3t} \quad \Rightarrow \quad \begin{aligned} y_k(0) &= C_1 + C_2 = 2 \\ y'_k(0) &= 3C_1 - 3C_2 = 0 \end{aligned} \quad \Rightarrow \quad C_1 = C_2 = 1.$$

Therefore,  $y_k(t) = e^{3t} + e^{-3t} = 2 \cosh 3t$  and

$$y(t) = (h * g)(t) + y_k(t) = \frac{1}{3} \int_0^t \sinh[3(t-v)]g(v) dv + 2 \cosh 3t.$$

- 26.** Taking the Laplace transform of both sides of the given equation and assuming zero initial conditions, we get

$$\mathcal{L}\{y'' + 2y' - 15y\}(s) = \mathcal{L}\{g(t)\}(s) \quad \Rightarrow \quad s^2 Y(s) + 2sY(s) - 15Y(s) = G(s).$$

Thus,

$$H(s) = \frac{Y(s)}{G(s)} = \frac{1}{s^2 + 2s - 15} = \frac{1}{(s-3)(s+5)}$$

is the transfer function. The impulse response function  $h(t)$  is then given by

$$\begin{aligned} h(t) &= \mathcal{L}^{-1} \left\{ \frac{1}{(s-3)(s+5)} \right\} (t) = e^{3t} * e^{-5t} \\ &= \int_0^t e^{3(t-v)} e^{-5v} dv = e^{3t} \left( -\frac{e^{-8v}}{8} \Big|_0^t \right) = \frac{e^{3t} - e^{-5t}}{8}. \end{aligned}$$

To solve the given initial value problem, we use Theorem 12. To this end, we need the solution  $y_k(t)$  to the corresponding initial value problem for the homogeneous equation.

That is,

$$y'' + 2y' - 15y = 0, \quad y(0) = 0, \quad y'(0) = 8.$$

Applying the Laplace transform yields

$$\begin{aligned} [s^2 Y_k(s) - 8] + 2[sY_k(s)] - 15Y_k(s) &= 0 \\ \Rightarrow Y_k(s) &= \frac{8}{s^2 + 2s - 15} = \frac{8}{(s-3)(s+5)} = \frac{1}{s-3} - \frac{1}{s+5} \\ \Rightarrow y_k(t) &= \mathcal{L}^{-1} \left\{ \frac{1}{s-3} - \frac{1}{s+5} \right\} (t) = e^{3t} - e^{-5t}. \end{aligned}$$

So,

$$y(t) = (h * g)(t) + y_k(t) = \frac{1}{8} \int_0^t [e^{3(t-v)} - e^{-5(t-v)}] g(v) dv + e^{3t} - e^{-5t}.$$

28. Taking the Laplace transform and assuming zero initial conditions, we find the transfer function  $H(s)$ .

$$s^2Y(s) - 4sY(s) + 5Y(s) = G(s) \quad \Rightarrow \quad H(s) = \frac{Y(s)}{G(s)} = \frac{1}{s^2 - 4s + 5} = \frac{1}{(s-2)^2 + 1}.$$

Therefore, the impulse response function is

$$h(t) = \mathcal{L}^{-1}\{H(s)\}(t) = \mathcal{L}^{-1}\left\{\frac{1}{(s-2)^2 + 1}\right\}(t) = e^{2t} \sin t.$$

Next, we find the solution  $y_k(t)$  to the corresponding initial value problem for the homogeneous equation,

$$y'' - 4y' + 5y = 0, \quad y(0) = 0, \quad y'(0) = 1.$$

Since the associated equation,  $r^2 - 4r + 5 = 0$ , has roots  $r = 2 \pm i$ , a general solution to the homogeneous equations is

$$y_h(t) = e^{2t} (C_1 \cos t + C_2 \sin t).$$

We satisfy the initial conditions by solving

$$\begin{aligned} 0 = y(0) &= C_1 & \Rightarrow & C_1 = 0, \\ 1 = y'(0) &= 2C_1 + C_2 & & C_2 = 1. \end{aligned}$$

Hence,  $y_k(t) = e^{2t} \sin t$  and

$$y(t) = (h * g)(t) + y_k(t) = \int_0^t e^{2(t-v)} [\sin(t-v)] g(v) dv + e^{2t} \sin t$$

is the desired solution.

30. With given data, the initial value problem becomes

$$10I''(t) + 80I'(t) + 410I(t) = e(t) \quad \Rightarrow \quad I''(t) + 8I'(t) + 41I(t) = \frac{e(t)}{10},$$

$I(0) = 2$ ,  $I'(0) = -8$ . Using formula (15) of the text, we find the transfer function

$$H(s) = \frac{1}{s^2 + 8s + 41} = \frac{1}{(s+4)^2 + 5^2}.$$

Therefore,

$$h(t) = \mathcal{L}^{-1}\left\{\frac{1}{(s+4)^2 + 5^2}\right\}(t) = \frac{1}{5} e^{-4t} \sin 5t.$$

## Chapter 7

Next, we consider the initial value problem

$$I''(t) + 8I'(t) + 41I(t) = 0, \quad I(0) = 2, \quad I'(0) = -8$$

for the corresponding homogeneous equation. Its characteristic equation,  $r^2 + 8r + 41 = 0$ , has roots  $r = -4 \pm 5i$ , which give a general solution

$$I_h(t) = e^{-4t} (C_1 \cos 5t + C_2 \sin 5t).$$

Next, we find constants  $C_1$  and  $C_2$  so that the solution satisfies the initial conditions. Thus, we have

$$\begin{aligned} 2 = I(0) &= C_1, & \Rightarrow & C_1 = 2, \\ -8 = I'(0) &= -4C_1 + 5C_2 & & C_2 = 0, \end{aligned}$$

and so  $I_k(t) = 2e^{-4t} \cos 5t$ . Finally,

$$I(t) = [h * (e/10)](t) + I_k(t) = \frac{1}{50} \int_0^t e^{-4(t-v)} \sin [5(t-v)] e(v) dv + 2e^{-4t} \cos 5t.$$

**32.** By the convolution theorem, we get

$$\mathcal{L}\{1 * t * t^2\}(s) = \mathcal{L}\{1\}(s) \mathcal{L}\{t\}(s) \mathcal{L}\{t^2\}(s) = \frac{1}{s} \cdot \frac{1}{s^2} \cdot \frac{2}{s^3} = \frac{2}{s^6}.$$

Therefore,

$$1 * t * t^2 = \mathcal{L}^{-1}\left\{\frac{2}{s^6}\right\}(t) = \frac{1}{60} \mathcal{L}^{-1}\left\{\frac{5!}{s^6}\right\}(t) = \frac{t^5}{60}.$$

**34.** Using the commutative property (4) of the convolution and Fubini's theorem yields

$$\begin{aligned} (f * g) * h &= (g * f) * h = \int_0^t (g * f)(t-v) h(v) dv \\ &= \int_0^t \left[ \int_0^{t-v} g(t-v-u) f(u) du \right] h(v) dv = \int_0^t \int_0^{t-v} g(t-v-u) f(u) h(v) du dv \\ &= \int_0^t \left[ \int_0^{t-u} g(t-u-v) h(v) dv \right] f(u) du = \int_0^t (g * h)(t-u) f(u) du \\ &= (g * h) * f = f * (g * h). \end{aligned}$$

36. Let

$$G(t) := \int_0^t \int_0^v f(z) dz dv.$$

Clearly,  $G(0) = 0$ . By the fundamental theorem of calculus,

$$G'(t) = \int_0^t f(z) dz, \quad G'(0) = 0, \quad G''(t) = f(t).$$

Therefore, by Theorem 5 in Section 7.3, we get

$$\begin{aligned} F(s) &= \mathcal{L}\{G''(t)\}(s) = s^2 \mathcal{L}\{G(t)\}(s) - sG(0) - G'(0) = s^2 \mathcal{L}\{G(t)\}(s) \\ \Rightarrow \quad \mathcal{L}\{G(t)\}(s) &= \frac{F(s)}{s^2} \quad \Rightarrow \quad G(t) = \mathcal{L}^{-1}\left\{\frac{F(s)}{s^2}\right\}(t). \end{aligned}$$

We now apply Theorem 11 to conclude that

$$\begin{aligned} \mathcal{L}^{-1}\left\{\frac{1}{s^2} F(s)\right\}(t) &= \left(\mathcal{L}^{-1}\left\{\frac{1}{s^2}\right\} * \mathcal{L}^{-1}\{F(s)\}\right)(t) = t * f(t) \\ &= \int_0^t (t-v)f(v) dv = t \int_0^t f(v) dv - \int_0^t v f(v) dv \end{aligned}$$

### EXERCISES 7.8: Impulses and the Dirac Delta Function

2. By equation (2) of the text,

$$\int_{-\infty}^{\infty} e^{3t} \delta(t) dt = e^{3t} \Big|_{t=0} = 1.$$

4. By equation (3),

$$\int_{-\infty}^{\infty} e^{-2t} \delta(t+1) dt = e^{-2t} \Big|_{t=-1} = e^2.$$

6. Since  $\delta(t) = 0$  for  $t \neq 0$ ,

$$\int_{-1}^1 (\cos 2t) \delta(t) dt = \int_{-\infty}^{\infty} (\cos 2t) \delta(t) dt = \cos 2t \Big|_{t=0} = 1.$$

8. Using the linearity of the Laplace transform and formula (6), we get

$$\mathcal{L}\{3\delta(t-1)\}(s) = 3\mathcal{L}\{\delta(t-1)\}(s) = 3e^{-s}.$$

## Chapter 7

10. Since  $\delta(t-3) = 0$  for  $t \neq 3$ ,

$$\mathcal{L}\{t^3\delta(t-3)\}(s) := \int_0^{\infty} e^{-st}t^3\delta(t-3)dt = \int_{-\infty}^{\infty} e^{-st}t^3\delta(t-3)dt = e^{-st^3} \Big|_{t=3} = 27e^{-3s}$$

by equation (3) of the text.

Another way to solve this problem is to use Theorem 6 in Section 7.3. This yields

$$\mathcal{L}\{t^3\delta(t-3)\}(s) = (-1)^3 \frac{d^3}{ds^3} \mathcal{L}\{\delta(t-3)\}(s) = -\frac{d^3(e^{-3s})}{ds^3} = 27e^{-3s}.$$

12. The translation property of the Laplace transform (Theorem 3, Section 7.3) yields

$$\mathcal{L}\{e^t\delta(t-3)\}(s) = \mathcal{L}\{\delta(t-3)\}(s-1) = e^{-3(s-1)} = e^{3(1-s)}.$$

14. Let  $Y(s) := \mathcal{L}\{y(t)\}(s)$ . Applying the Laplace transform to both sides of the given equation, using Theorem 5 in Section 7.3 and the initial conditions, we find that

$$[s^2Y(s) - s - 1] + 2[sY(s) - 1] + 2Y(s) = \mathcal{L}\{\delta(t-\pi)\}(s) = e^{-\pi s}.$$

Solving for  $Y(s)$  yields

$$Y(s) = e^{-\pi s} \frac{1}{s^2 + 2s + 2} + \frac{s+3}{s^2 + 2s + 2} = e^{-\pi s} \frac{1}{(s+1)^2 + 1} + \frac{s+1}{(s+1)^2 + 1} + 2 \frac{1}{(s+1)^2 + 1}$$

Thus, by Theorem 8, Section 7.6 and Table 7.1 in Section 7.2,

$$\begin{aligned} y(t) &= [e^{-(t-\pi)} \sin(t-\pi)] u(t-\pi) + e^{-t} \cos t + 2e^{-t} \sin t \\ &= -e^{\pi-t} (\sin t) u(t-\pi) + e^{-t} \cos t + 2e^{-t} \sin t. \end{aligned}$$

16. Let  $Y := \mathcal{L}\{y\}$ . Taking the Laplace transform of  $y'' - 2y' - 3y = 2\delta(t-1) - \delta(t-3)$  and applying the initial conditions  $y(0) = 2$ ,  $y'(0) = 2$ , we obtain

$$\begin{aligned} (s^2Y - 2s - 2) - 2(sY - 2) - 3Y &= \mathcal{L}\{2\delta(t-1) - \delta(t-3)\} = 2e^{-s} - e^{-3s} \\ \Rightarrow Y(s) &= \frac{2s - 2 + 2e^{-s} - e^{-3s}}{s^2 - 2s - 3} = \frac{2s - 2 + e^{-s} + e^{-3s}}{(s-3)(s+1)} \\ &= \frac{1}{s-3} + \frac{1}{s+1} + \frac{e^{-s}}{2} \left( \frac{1}{s-3} - \frac{1}{s+1} \right) - \frac{e^{-3s}}{4} \left( \frac{1}{s-3} - \frac{1}{s+1} \right), \end{aligned}$$

so that by Theorem 8, Section 7.6, we get

$$y(t) = e^{3t} + e^{-t} + \frac{1}{2} [e^{3(t-1)} - e^{-(t-1)}] u(t-1) - \frac{1}{4} [e^{3(t-3)} - e^{-(t-3)}] u(t-3).$$

18. Let  $Y := \mathcal{L}\{y\}$ . Taking the Laplace transform of  $y'' - y' - 2y = 3\delta(t-1) + e^t$  and applying the initial conditions  $y(0) = 0$ ,  $y'(0) = 3$ , we obtain

$$\begin{aligned}(s^2Y - 3) - (sY) - 2Y &= \mathcal{L}\{3\delta(t-1) + e^t\} = \frac{1}{s-1} + 3e^{-s} \\ \Rightarrow Y(s) &= \frac{3s-2}{(s-1)(s^2-s-2)} + e^{-s} \frac{3}{s^2-s-2} \\ &= \frac{3s-2}{(s-1)(s-2)(s+1)} + e^{-s} \frac{3}{(s-2)(s+1)}.\end{aligned}$$

Taking the partial fractions decompositions yields

$$Y(s) = \frac{4}{3} \frac{1}{s-2} - \frac{1}{2} \frac{1}{s-1} - \frac{5}{6} \frac{1}{s+1} + e^{-s} \left( \frac{1}{s-2} - \frac{1}{s+1} \right)$$

so that from Table 7.1 in Section 7.2 and Theorem 8, Section 7.6, we get

$$y(t) = \frac{4}{3} e^{2t} - \frac{1}{2} e^t - \frac{5}{6} e^{-t} + [e^{2(t-1)} - e^{-(t-1)}] u(t-1).$$

20. By the translation property of the Laplace transform,

$$\mathcal{L}\{e^{-t}\delta(t-2)\}(s) = \mathcal{L}\{\delta(t-2)\}(s+1) = e^{-2(s+1)}.$$

Thus, the Laplace transform of the given equation yields

$$\mathcal{L}\{y'' + 5y' + 6y\} = (s^2Y - 2s + 5) + 5(sY - 2) + 6Y = e^{-2(s+1)}$$

or, solving for  $Y := \mathcal{L}\{y(t)\}(s)$ ,

$$\begin{aligned}Y &= \frac{2s+5+e^{-2(s+1)}}{s^2+5s+6} \frac{2s+5+e^{-2(s+1)}}{(s+2)(s+3)} \\ &= \frac{1}{s+2} + \frac{1}{s+3} + e^{-2} e^{-2s} \left( \frac{1}{s+2} - \frac{1}{s+3} \right).\end{aligned}$$

Applying now the inverse Laplace transform, we get

$$\begin{aligned}y(t) &= e^{-2t} + e^{-3t} + e^{-2} (e^{-2x} - e^{-3x}) \Big|_{x=t-2} u(t-2) \\ &= e^{-2t} + e^{-3t} + e^{-2} [e^{-2(t-2)} - e^{-3(t-2)}] u(t-2).\end{aligned}$$

22. We apply the Laplace transform to the given equation, solve the resulting equation for  $Y = \mathcal{L}\{y\}(s)$ , and then use the inverse Laplace transform. This yields

$$\mathcal{L}\{y''\}(s) + \mathcal{L}\{y\}(s) = \mathcal{L}\left\{\delta\left(t - \frac{\pi}{2}\right)\right\}(s)$$

## Chapter 7

$$\begin{aligned} \Rightarrow & [s^2Y(s) - 1] + Y(s) = e^{-\pi s/2} \\ \Rightarrow & Y(s) = \frac{1}{s^2 + 1} + e^{-\pi s/2} \frac{1}{s^2 + 1} \\ \Rightarrow & y(t) = \sin t + \left[ \sin \left( t - \frac{\pi}{2} \right) \right] u \left( t - \frac{\pi}{2} \right) = \sin t + (\cos t)u \left( t - \frac{\pi}{2} \right). \end{aligned}$$

The graph of the solution is shown in Fig. 7–M on page 266.

24. Similarly to Problem 22, we get

$$\begin{aligned} [s^2Y(s) - 1] + Y(s) &= e^{-\pi s} - e^{-2\pi s} \\ \Rightarrow Y(s) &= \frac{1}{s^2 + 1} + (e^{-\pi s} - e^{-2\pi s}) \frac{1}{s^2 + 1} \\ \Rightarrow y(t) &= \sin t + [\sin(t - \pi)]u(t - \pi) - [\sin(t - 2\pi)]u(t - 2\pi) \\ &= (\sin t)[1 - u(t - \pi) - u(t - 2\pi)]. \end{aligned}$$

The graph of the solution is shown in Fig. 7–N on page 266.

26. The Laplace transform of both sides of the given equation (with zero initial conditions) yields

$$s^2Y(s) - 6sY(s) + 13Y(s) = \mathcal{L}\{\delta(t)\}(s) = 1.$$

Thus,

$$Y(s) = \frac{1}{s^2 - 6s + 13} = \frac{1}{(s - 3)^2 + 2^2} = \frac{1}{2} \frac{2}{(s - 3)^2 + 2^2}.$$

Therefore, the impulse response function is

$$h(t) = \mathcal{L}^{-1}\{Y(s)\}(t) = \frac{1}{2} e^{3t} \sin 2t.$$

28. The Laplace transform of both sides of the given equation (with zero initial conditions) yields

$$s^2Y(s) - Y(s) = \mathcal{L}\{\delta(t)\}(s) = 1.$$

Thus,

$$Y(s) = \frac{1}{s^2 - 1} = \frac{1}{(s - 1)(s + 1)} = \frac{1}{2} \left( \frac{1}{s - 1} - \frac{1}{s + 1} \right).$$

Therefore, the impulse response function is

$$h(t) = \mathcal{L}^{-1}\{Y(s)\}(t) = \frac{1}{2} (e^t - e^{-t}) = \sinh t.$$

**30.** Let  $Y := \mathcal{L}\{y(t)\}$ . The Laplace transform of the left-hand side of the given equation (with the imposed initial conditions) is  $(s^2 + 1)Y(s)$ . For the right-hand side, one has

$$\mathcal{L}\left\{\sum_{k=1}^{\infty} \delta(t - 2k\pi)\right\}(s) = \sum_{k=1}^{\infty} e^{-2k\pi s}.$$

Hence,

$$Y(s) = \frac{1}{s^2 + 1} \sum_{k=1}^{\infty} e^{-2k\pi s}.$$

Taking the inverse Laplace transform in this equation yields the following sum  $y(t)$  of the series of impulse response functions  $h_k(t)$ :

$$\begin{aligned} y(t) &= \sum_{k=1}^{\infty} h_k(t) := \sum_{k=1}^{\infty} \sin(t - 2k\pi) u(t - 2k\pi) \\ &= \sum_{k=1}^{\infty} (\sin t) u(t - 2k\pi) = (\sin t) \sum_{k=1}^{\infty} u(t - 2k\pi). \end{aligned}$$

Evaluating  $y(t)$  at, say,  $t_n = (\pi/2) + 2n\pi$  for  $n = 1, 2, \dots$  we see that

$$y(t_n) = \left[ \sin\left(\frac{\pi}{2} + 2n\pi\right) \right] \sum_{k=1}^{\infty} u(t - 2k\pi) = \sum_{k=1}^n (1) = n \rightarrow \infty$$

with  $t_n \rightarrow \infty$ , meaning that the bridge will eventually collapse.

**32.** By taking the Laplace transform of

$$ay'' + by' + cy = \delta(t), \quad y(0) = y'(0) = 0,$$

and solving for  $Y := \mathcal{L}\{y\}$ , we find that the transfer function is given by

$$H(s) = \frac{1}{as^2 + bs + c}.$$

We consider the following possibilities.

(i) If the roots of the polynomial  $as^2 + bs + c$  are real and distinct, say  $r_1, r_2$ , then

$$H(s) = \frac{1}{a(s - r_1)(s - r_2)} = \frac{1}{a(r_1 - r_2)} \left( \frac{1}{s - r_1} - \frac{1}{s - r_2} \right).$$

Thus,

$$h(t) = \mathcal{L}^{-1}\{H(s)\}(t) = \frac{1}{a(r_1 - r_2)} (e^{r_1 t} - e^{r_2 t})$$

and, clearly,  $h(t)$  has zero limit as  $t \rightarrow \infty$  if and only if  $r_1$  and  $r_2$  are negative.



## Chapter 7

- (ii) If the roots of  $as^2 + bs + c$  are complex, then they are  $\alpha \pm i\beta$ , where  $\alpha$  and  $\beta \neq 0$  satisfy

$$H(s) = \frac{1}{a[(s - \alpha)^2 + \beta^2]}$$

so that

$$h(t) = \mathcal{L}^{-1}\{H(s)\}(t) = \frac{1}{a\beta} e^{\alpha t} \sin \beta t,$$

and, again, it is clear that  $h(t) \rightarrow 0$  as  $t \rightarrow \infty$  if and only if the real part  $\alpha$  of the roots is negative.

- (iii) Finally, if the characteristic equation has a double real root  $r_0$ , then

$$H(s) = \frac{1}{a(r - r_0)^2},$$

implying that

$$h(t) = \mathcal{L}^{-1}\{H(s)\}(t) = \frac{1}{a} t e^{r_0 t},$$

which, again, vanishes at infinity if and only if  $r_0 < 0$ .

- 34.** Let a function  $f(t)$  be defined and  $n$  times continuously differentiable in a neighborhood  $[-\epsilon, \epsilon]$  of the origin. Since, for  $t \neq 0$ ,  $\delta(t)$  and all its derivatives equal zero, we can (formally) consider the improper integral  $\int_{-\infty}^{\infty} f(t)\delta^{(n)}(t)dt$  assuming that the integrand vanishes outside of  $[-\epsilon, \epsilon]$ . Then, applying integration by parts  $n$  times yields

$$\begin{aligned} \int_{-\infty}^{\infty} f(t)\delta^{(n)}(t) dt &= \int_{-\epsilon}^{\epsilon} f(t)\delta^{(n)}(t) dt = f(t)\delta^{(n-1)}(t)\Big|_{-\epsilon}^{\epsilon} - \int_{-\epsilon}^{\epsilon} f'(t)\delta^{(n-1)}(t) dt \\ &= - \int_{-\epsilon}^{\epsilon} f'(t)\delta^{(n-1)}(t) dt = \dots = (-1)^n \int_{-\epsilon}^{\epsilon} f^{(n)}(t)\delta(t) dt \\ &= (-1)^n \int_{-\infty}^{\infty} f^{(n)}(t)\delta(t) dt = (-1)^n f^{(n)}(0) \end{aligned}$$

by equation (2) of the text.

### EXERCISES 7.9: Solving Linear Systems with Laplace Transforms

- 2.** Let  $X = \mathcal{L}\{x\}$ ,  $Y = \mathcal{L}\{y\}$ . Applying the Laplace transform to both sides of the given equations and using Theorem 4, Section 7.3, for evaluating Laplace transforms of the

derivatives yields

$$\begin{aligned} sX(s) + 1 &= X(s) - Y(s) & \Rightarrow & \quad (s-1)X(s) + Y(s) = -1 \\ sY(s) &= 2X(s) + 4Y(s) & & \quad -2X(s) + (s-4)Y(s) = 0. \end{aligned}$$

Solving this system for, say,  $Y(s)$ , we obtain

$$Y(s) = -\frac{2}{s^2 - 5s + 6} = -\frac{2}{(s-2)(s-3)} = \frac{2}{s-2} - \frac{2}{s-3}.$$

Therefore,

$$y(t) = \mathcal{L}^{-1} \left\{ \frac{2}{s-2} - \frac{2}{s-3} \right\} (t) = 2e^{2t} - 2e^{3t}.$$

From the second equation in the given system we find that

$$x(t) = \frac{1}{2} (y' - 4y) = \frac{1}{2} [(4e^{2t} - 6e^{3t}) - 4(2e^{2t} - 2e^{3t})] = -2e^{2t} + e^{3t}.$$

4. Let  $X = \mathcal{L}\{x\}$ ,  $Y = \mathcal{L}\{y\}$ . Applying the Laplace transform to both sides of the given equations and using Theorem 4, Section 7.3, for evaluating Laplace transforms of the derivatives yields

$$\begin{aligned} sX(s) - 3X(s) + 2Y(s) &= 1/(s^2 + 1) & \Rightarrow & \quad (s-3)X(s) + 2Y(s) = 1/(s^2 + 1) \\ 4X(s) - sY(s) - Y(s) &= s/(s^2 + 1) & & \quad 4X(s) - (s+1)Y(s) = s/(s^2 + 1). \end{aligned}$$

Solving this system for  $X(s)$ , we obtain

$$X(s) = \frac{3s + 1}{(s^2 + 1)(s^2 - 2s + 5)} = \frac{3s + 1}{(s^2 + 1)[(s-1)^2 + 2^2]}.$$

The partial fractions decomposition for  $X(s)$  is

$$X(s) = \frac{7}{10} \frac{s}{s^2 + 1} - \frac{1}{10} \frac{1}{s^2 + 1} - \frac{7}{10} \frac{s-1}{(s-1)^2 + 2^2} + \frac{2}{5} \frac{2}{(s-1)^2 + 2^2}.$$

Hence, the inverse Laplace transform gives us

$$x(t) = \left(\frac{7}{10}\right) \cos t - \left(\frac{1}{10}\right) \sin t - \left(\frac{7}{10}\right) e^t \cos 2t + \left(\frac{2}{5}\right) e^t \sin 2t.$$

From the first equation in the system,

$$y(t) = \frac{\sin t - x'(t) + 3x(t)}{2}.$$

Substituting the solution  $x(t)$  and collecting similar terms yields

$$y(t) = \left(\frac{11}{10}\right) \cos t + \left(\frac{7}{10}\right) \sin t - \left(\frac{11}{10}\right) e^t \cos 2t - \left(\frac{3}{5}\right) e^t \sin 2t.$$

## Chapter 7

6. Denote  $X = \mathcal{L}\{x\}$ ,  $Y = \mathcal{L}\{y\}$ . The Laplace transform of the given equations yields

$$\begin{aligned} sX(s) - X(s) - Y(s) &= 1/s & \Rightarrow & & (s-1)X(s) - Y(s) &= 1/s \\ -X(s) + sY(s) + (5/2) - Y(s) &= 0 & & & -X(s) + (s-1)Y(s) &= -(5/2). \end{aligned}$$

We multiply the first equation by  $(s-1)$  and add to the second equation.

$$\begin{aligned} [(s-1)^2 - 1]X(s) &= \frac{s-1}{s} - \frac{5}{2} = -\frac{3s+2}{2s} \\ \Rightarrow X(s) &= -\frac{3s+2}{2s[(s-1)^2 - 1]} = -\frac{1}{2} \frac{3s+2}{s^2(s+2)} = \frac{1}{2s^2} + \frac{1}{s} - \frac{1}{s-2}. \end{aligned}$$

Taking the inverse Laplace transform we find

$$x(t) = \frac{t}{2} + 1 - e^{2t}.$$

From the first equation in the given system,

$$y(t) = x'(t) - x(t) - 1 = -\frac{t}{2} - \frac{3}{2} - e^{2t}.$$

8. By taking the Laplace transform of both sides of these differential equations and using the linearity of the Laplace transform, we obtain

$$\begin{aligned} \mathcal{L}\{D[x]\}(s) + \mathcal{L}\{y\}(s) &= \mathcal{L}\{0\}(s) = 0 & \Rightarrow & & sX(s) - (7/4) + Y(s) &= 0 \\ 4\mathcal{L}\{x\}(s) + \mathcal{L}\{D[y]\}(s) &= \mathcal{L}\{3\}(s) = 3/s & & & 4X(s) + sY(s) - 4 &= 3/s \end{aligned}$$

or, equivalently,

$$\begin{aligned} sX(s) + Y(s) &= (7/4) \\ 4X(s) + sY(s) &= (4s+3)/s, \end{aligned}$$

where  $X(s)$  and  $Y(s)$  are the Laplace transforms of  $x(t)$  and  $y(t)$ , respectively. Solving this system for  $X(s)$  yields

$$X(s) = \frac{7s^2 - 16s - 12}{4s(s^2 - 4)} = \left(\frac{3}{4}\right) \frac{1}{s} + \left(\frac{3}{2}\right) \frac{1}{s+2} - \left(\frac{1}{2}\right) \frac{1}{s-2}.$$

The inverse Laplace transform leads now to

$$x(t) = \mathcal{L}^{-1} \left\{ \left(\frac{3}{4}\right) \frac{1}{s} + \left(\frac{3}{2}\right) \frac{1}{s+2} - \left(\frac{1}{2}\right) \frac{1}{s-2} \right\} (t) = \frac{3}{4} + \left(\frac{3}{2}\right) e^{-2t} - \left(\frac{1}{2}\right) e^{2t}.$$

Differentiating  $x(t)$ , we find  $y(t)$ . (See the first equation in the given system.)

$$y(t) = -x'(t) = 3e^{-2t} + e^{2t}.$$

10. Denote  $X = \mathcal{L}\{x\}$ ,  $Y = \mathcal{L}\{y\}$ . The Laplace transform of the given equations (for the given initial conditions) yields

$$\begin{aligned} s^2X(s) - s - 1 + Y(s) &= 1/s \\ X(s) + s^2Y(s) - s + 1 &= -1/s \end{aligned} \quad \Rightarrow \quad \begin{aligned} s^2X(s) + Y(s) &= s + 1 + (1/s) \\ X(s) + s^2Y(s) &= s - 1 - (1/s). \end{aligned}$$

If we multiply the first equation by  $s^2$  and subtract the second equation from the result, we get

$$\begin{aligned} (s^4 - 1)X(s) &= s^3 + s^2 + 1 + \frac{1}{s} = \frac{s^4 + s^3 + s + 1}{s} \\ \Rightarrow X(s) &= \frac{s^4 + s^3 + s + 1}{s(s^4 - 1)} = \frac{s^4 + s^3 + s + 1}{s(s-1)(s+1)(s^2+1)}, \end{aligned}$$

which, using partial fractions, can be written as

$$X(s) = \frac{s}{s^2 + 1} + \frac{1}{s - 1} - \frac{1}{s}.$$

Taking the inverse Laplace transform, we find that

$$x(t) = \cos t + e^t - 1.$$

From the first equation in the given system,

$$y(t) = 1 - x''(t) = \cos t - e^t + 1.$$

12. Since

$$\begin{aligned} \mathcal{L}\{x'\}(s) &= sX(s) - x(0) = sX(s), \\ \mathcal{L}\{y''\}(s) &= s^2Y(s) - sy(0) - y'(0) = s^2Y(s) - s + 1, \end{aligned}$$

applying the Laplace transform to the given equations yields

$$\begin{aligned} sX(s) + Y(s) &= X(s) \\ 2sX(s) + s^2Y(s) - s + 1 &= e^{-3s}/s \end{aligned} \quad \Rightarrow \quad \begin{aligned} (s-1)X(s) + Y(s) &= 0 \\ 2sX(s) + s^2Y(s) &= s - 1 + e^{-3s}/s. \end{aligned}$$

Solving for  $X(s)$  yields

$$\begin{aligned} X(s) &= \frac{1 - s - e^{-3s}}{s(s^2 - s - 2)} = \frac{1 - s}{s(s+1)(s-2)} - e^{-3s} \frac{1}{s^2(s+1)(s-2)} \\ &= -\frac{1}{2s} + \frac{(2/3)}{s+1} - \frac{(1/6)}{s-2} - e^{-3s} \left[ \frac{1}{4s} - \frac{1}{2s^2} - \frac{(1/3)}{s+1} + \frac{(1/12)}{s-2} \right]. \end{aligned}$$

## Chapter 7

Using linearity of the inverse Laplace transform and formula (6) in Section 7.6, we get

$$\begin{aligned} x(t) &= -\frac{1}{2} + \left(\frac{2}{3}\right) e^{-t} - \left(\frac{1}{6}\right) e^{2t} - \left[ \frac{1}{4} - \frac{x}{2} - \left(\frac{1}{3}\right) e^{-x} + \left(\frac{1}{12}\right) e^{2x} \right] \Big|_{x=t-3} u(t-3) \\ &= -\frac{1}{2} + \frac{2e^{-t}}{3} - \frac{e^{2t}}{6} - \left( \frac{1}{4} - \frac{t-3}{2} - \frac{e^{3-t}}{3} + \frac{e^{2t-6}}{12} \right) u(t-3). \end{aligned}$$

Since  $y = x - x'$  (see the first equation in the given system), we obtain

$$y(t) = -\frac{1}{2} + \frac{4e^{-t}}{3} + \frac{e^{2t}}{6} - \left( \frac{3}{4} - \frac{t-3}{2} - \frac{2e^{3-t}}{3} - \frac{e^{2t-6}}{12} \right) u(t-3).$$

14. Since

$$\begin{aligned} \mathcal{L}\{x''\}(s) &= s^2X(s) - sx(0) - x'(0) = s^2X(s) - s, \\ \mathcal{L}\{y''\}(s) &= s^2Y(s) - sy(0) - y'(0) = s^2Y(s), \end{aligned}$$

applying the Laplace transform to the given equations yields

$$\begin{aligned} s^2X(s) - s &= Y(s) + e^{-s}/s & \Rightarrow & \quad s^2X(s) - Y(s) = s + (e^{-s}/s) \\ s^2Y(s) &= X(s) + (1/s) - e^{-s}/s & \Rightarrow & \quad -X(s) + s^2Y(s) = (1/s) - (e^{-3s}/s). \end{aligned}$$

Solving for  $X(s)$  yields

$$\begin{aligned} X(s) &= \frac{s^4 + 1}{s(s^4 - 1)} + \frac{s^2 - 1}{s(s^4 - 1)} e^{-s} = \frac{s^4 + 1}{s(s^4 - 1)} + \frac{1}{s(s^2 + 1)} e^{-s} \\ &= -\frac{1}{s} + \left(\frac{1}{2}\right) \frac{1}{s+1} + \left(\frac{1}{2}\right) \frac{1}{s-1} + \frac{s}{s^2 + 1} + \left(\frac{1}{s} - \frac{s}{s^2 + 1}\right) e^{-s}. \end{aligned}$$

Using linearity of the inverse Laplace transform and formula (6) in Section 7.6, we get

$$\begin{aligned} x(t) &= -1 + \frac{e^{-t}}{2} + \frac{e^t}{2} + \cos t + [1 - \cos(t-1)] u(t-1) \\ &= \cosh t + \cos t - 1 + [1 - \cos(t-1)] u(t-1). \end{aligned}$$

Since  $y = x'' - u(t-1)$  (see the first equation in the system), after some algebra we obtain

$$y(t) = \cosh t - \cos t - [1 - \cos(t-1)] u(t-1).$$

16. First, note that the initial conditions are given at the point  $t = \pi$ . Thus, for the Laplace transform method, we have to shift the argument to get zero initial point. Let us denote

$$w(t) := x(t+1) \quad \text{and} \quad v(t) := y(t+\pi).$$

The chain rule yields

$$w'(t) = x'(t + \pi)(t + \pi)' = x'(t + \pi), \quad v'(t) = y'(t + \pi)(t + \pi)' = y'(t + \pi).$$

In the original system, we substitute  $t + \pi$  for  $t$  to get

$$w'(t) - 2w(t) + v'(t) = -[\cos(t + \pi) + 4\sin(t + \pi)] = \cos t + 4\sin t$$

$$2w(t) + v'(t) + v(t) = \sin(t + \pi) + 3\cos(t + \pi) = -\sin t - 3\cos t$$

with initial conditions  $w(0) = x(\pi) = 0$ ,  $v(0) = y(\pi) = 3$ . Taking the Laplace transform and using Theorem 4, Section 7.3, we obtain the system

$$\begin{aligned} sW(s) - 2W(s) + sV(s) - 3 &= \frac{s + 4}{s^2 + 1} \\ 2W(s) + sV(s) - 3 + V(s) &= \frac{-3s - 1}{s^2 + 1} \end{aligned}$$

or, after collecting similar terms,

$$\begin{aligned} (s - 2)W(s) + sV(s) &= \frac{3s^2 + s + 7}{s^2 + 1} \\ 2W(s) + (s + 1)V(s) &= \frac{3s^2 - 3s + 2}{s^2 + 1}. \end{aligned}$$

Solving this system for  $V(s)$  yields

$$\begin{aligned} V(s) &= \frac{3s^3 - 15s^2 + 6s - 18}{(s^2 + 1)(s^2 - 3s - 2)} = \frac{3s^3 - 15s^2 + 6s - 18}{(s^2 + 1)[s - (3 + \sqrt{17})/2][s - (3 - \sqrt{17})/2]} \\ &= -\frac{s}{s^2 + 1} + \left(\frac{2\sqrt{17} - 12}{\sqrt{17}}\right) \frac{1}{s - (3 + \sqrt{17})/2} + \left(\frac{2\sqrt{17} + 12}{\sqrt{17}}\right) \frac{1}{s - (3 - \sqrt{17})/2}. \end{aligned}$$

Therefore, taking the inverse Laplace transform, we obtain

$$v(t) = -\cos t + \left(\frac{2\sqrt{17} - 12}{\sqrt{17}}\right) e^{(3+\sqrt{17})t/2} + \left(\frac{2\sqrt{17} + 12}{\sqrt{17}}\right) e^{(3-\sqrt{17})t/2}.$$

Shifting the argument back gives

$$y(t) = v(t - \pi) = \cos t + \left(\frac{2\sqrt{17} - 12}{\sqrt{17}}\right) e^{(3+\sqrt{17})(t-\pi)/2} + \left(\frac{2\sqrt{17} + 12}{\sqrt{17}}\right) e^{(3-\sqrt{17})(t-\pi)/2}.$$

We can now find  $x(t)$  by substituting  $y(t)$  into the second equation of the original system.

$$\begin{aligned} x(t) &= \frac{\sin t + 3\cos t - y'(t) - y(t)}{2} \\ &= \cos t + \sin t + \left(\frac{\sqrt{17} + 13}{2\sqrt{17}}\right) e^{(3+\sqrt{17})(t-\pi)/2} + \left(\frac{\sqrt{17} - 13}{2\sqrt{17}}\right) e^{(3-\sqrt{17})(t-\pi)/2}. \end{aligned}$$

## Chapter 7

- 18.** We first take the Laplace transform of both sides of all three of these equations and use the initial conditions to obtain a system of equations for the Laplace transforms of the solution functions.

$$\begin{aligned} sX(s) - 2Y(s) &= 0 & sX(s) - 2Y(s) &= 0 \\ sX(s) - [sZ(s) + 2] &= 0 & \Rightarrow & sX(s) - sZ(s) = 2 \\ X(s) + sY(s) - Z(s) &= 3/s & X(s) + sY(s) - Z(s) &= 3/s. \end{aligned}$$

Solving this system yields

$$X(s) = \frac{2}{s^3}, \quad Y(s) = \frac{1}{s^2}, \quad Z(s) = \frac{2}{s^3} - \frac{2}{s}.$$

Taking the inverse Laplace transforms, we get

$$x(t) = \mathcal{L}^{-1}\{X(s)\}(t) = t^2, \quad y(t) = \mathcal{L}^{-1}\{Y(s)\}(t) = t, \quad z(t) = \mathcal{L}^{-1}\{Z(s)\}(t) = t^2 - 2.$$

- 20.** Taking the Laplace transforms of the given equations yields

$$\begin{aligned} s^2X(s) - 3s + sY(s) - y(0) &= 2/s & \Rightarrow & s^2X(s) + sY(s) - y(0) = 2/s + 3s \\ 4X(s) + sY(s) - y(0) &= 6/s & & 4X(s) + sY(s) - y(0) = 6/s. \end{aligned}$$

Subtracting the second equation from the first one, we get

$$(s^2 - 4)X(s) = \frac{3s^2 - 4}{s} \quad \Rightarrow \quad X(s) = \frac{3s^2 - 4}{s(s^2 - 4)} = \frac{1}{s} + \frac{1}{s - 2} + \frac{1}{s + 2}.$$

We now take the inverse Laplace transform and conclude that

$$x(t) = \mathcal{L}^{-1}\{X(s)\}(t) = 1 + e^{2t} + e^{-2t} = 1 + 2 \cosh 2t.$$

From the second equation in the original system,

$$y'(t) = 6 - 4x(t) = 2 - 8 \cosh 2t.$$

Integrating  $y'(s)$  from  $s = 1$  (due to the initial condition) to  $s = t$  we obtain

$$y(t) = \int_1^t (2 - 8 \cosh 2s) ds + 4 = (2s - 4 \sinh 2s) \Big|_1^t + 4 = 2t - 4 \sinh 2t + 2 + 4 \sinh 2.$$

- 22.** For the mass  $m_1$  there is only one force acting on it, that is, the force due to the spring with the spring constant  $k_1$ ; so, it equals to  $-k_1(x - y)$ . Hence, we get

$$m_1 x'' = -k_1(x - y).$$

For the mass  $m_2$ , there are two forces: the force due to the spring with the spring constant  $k_2$ , which is  $-k_2y$ ; and the force due to the spring with the spring constant  $k_1$ , which is  $k_1(y - x)$ . Thus, we get

$$m_2y'' = k_1(x - y) - k_2y.$$

Therefore, the system governing the motion is

$$\begin{aligned} m_1x'' &= k_1(y - x) \\ m_2y'' &= -k_1(y - x) - k_2y. \end{aligned}$$

With  $m_1 = 1$ ,  $m_2 = 2$ ,  $k_1 = 4$ , and  $k_2 = 10/3$  the system becomes

$$\begin{aligned} x'' + 4x - 4y &= 0 \\ -4x + 2y'' + (22/3)y &= 0 \end{aligned} \tag{7.26}$$

with initial conditions

$$x(0) = -1, \quad x'(0) = 0, \quad y(0) = 0, \quad y'(0) = 0.$$

The Laplace transform of this system yields

$$\begin{aligned} [s^2X(s) + s] + 4X(s) - 4Y(s) &= 0 \\ -4X(s) + 2[s^2Y(s)] + (22/3)Y(s) &= 0 \end{aligned} \quad \Rightarrow \quad \begin{aligned} (s^2 + 4)X(s) - 4Y(s) &= -s \\ -2X(s) + (s^2 + (11/3))Y(s) &= 0. \end{aligned}$$

Multiplying the first equation by 2, the second equation  $-$  by  $s^2 + 4$  and adding the results together, we obtain

$$\begin{aligned} \left[ \left( s^2 + \frac{11}{3} \right) (s^2 + 4) - 8 \right] Y(s) &= -2s \\ \Rightarrow Y(s) &= -\frac{6s}{3s^4 + 23s^2 + 20} = -\left( \frac{6}{17} \right) \frac{s}{s^2 + 1} + \left( \frac{6}{17} \right) \frac{s}{s^2 + (20/3)}. \end{aligned}$$

Therefore,

$$y(t) = \mathcal{L}^{-1}\{Y(s)\}(t) = -\left( \frac{6}{17} \right) \cos t + \left( \frac{6}{17} \right) \cos \left( \sqrt{\frac{20}{3}} t \right).$$

From the second equation in (7.26), we have

$$x(t) = \frac{y''(t) + (11/3)y(t)}{2} = -\left( \frac{8}{17} \right) \cos t - \left( \frac{9}{17} \right) \cos \left( \sqrt{\frac{20}{3}} t \right).$$



## Chapter 7

24. Recall that Kirchhoff's voltage law says that, in an electrical circuit consisting of an inductor of  $L$  (H), a resistor of  $R$  ( $\Omega$ ), a capacitor of  $C$  (F), and a voltage source of  $E$  (V),

$$E_L + E_R + E_C = E, \quad (7.27)$$

where  $E_L$ ,  $E_R$ , and  $E_C$  denote the voltage drops across the inductor, resistor, and capacitor, respectively. These voltage drops are given by

$$E_L = L \frac{dI}{dt}, \quad E_R := RI, \quad E_C := \frac{q}{C}, \quad (7.28)$$

where  $I$  denotes the current passing through the correspondent element.

Also, Kirchhoff's current law states that the algebraic sum of currents passing through any point in an electrical network is zero.

The electrical network shown in Figure 7.29 consists of three closed circuits: loop 1 through the battery  $B = 50$  (V),  $L_1 = 0.005$  (H) inductor, and  $R_1 = 10$  ( $\Omega$ ) resistor; loop 2 through the resistor  $R_1$ , the inductor  $L_2 = 0.01$  (H), and the resistor  $R_2 = 20$  ( $\Omega$ ); loop 3 through the battery  $B$ , the inductors  $L_1$  and  $L_2$ , and the resistor  $R_2$ . We apply Kirchhoff's voltage law (7.27) to two of these loops, say, the loop 1 and the loop 2 (since the equation obtained from Kirchhoff's voltage law for the loop 3 is a linear combination of the other two), and Kirchhoff's current law to one of the junction points, say, the upper one. Thus, choosing the clockwise direction in the loops and using formulas (7.28), we obtain

Loop 1:

$$E_{L_1} + E_{R_1} = E \quad \Rightarrow \quad 0.005I_1' + 10I_2 = 50;$$

Loop 2:

$$E_{R_1} + E_{L_2} + E_{R_2} = 0 \quad \Rightarrow \quad 0.01I_3' + 10(-I_2 + 2I_3) = 0$$

with the negative sign at  $I_2$  due to the opposite direction of the current in this loop versus to that in Loop 1;

Upper junction point:

$$I_1 - I_2 - I_3 = 0.$$

Therefore, we have the following system for the currents  $I_1$ ,  $I_2$ , and  $I_3$ :

$$\begin{aligned} 0.005I_1' + 10I_2 &= 50 \\ 0.01I_3' + 10(-I_2 + 2I_3) &= 0 \\ I_1 - I_2 - I_3 &= 0 \end{aligned} \tag{7.29}$$

with initial conditions  $I_1(0) = I_2(0) = I_3(0) = 0$ .

Let  $\mathbf{I}_1(s) := \mathcal{L}\{I_1\}(s)$ ,  $\mathbf{I}_2(s) := \mathcal{L}\{I_2\}(s)$ , and  $\mathbf{I}_3(s) := \mathcal{L}\{I_3\}(s)$ . Using the initial conditions, we conclude that

$$\begin{aligned} \mathcal{L}\{I_1'\}(s) &= s\mathbf{I}_1(s) - I_1(0) = s\mathbf{I}_1(s), \\ \mathcal{L}\{I_3'\}(s) &= s\mathbf{I}_3(s) - I_3(0) = s\mathbf{I}_3(s). \end{aligned}$$

Using these equations and taking the Laplace transform of the equations in (7.29), we come up with

$$\begin{aligned} 0.005s\mathbf{I}_1(s) + 10\mathbf{I}_2(s) &= \frac{50}{s} \\ -10\mathbf{I}_2(s) + (0.01s + 20)\mathbf{I}_3(s) &= 0 \\ \mathbf{I}_1(s) - \mathbf{I}_2(s) - \mathbf{I}_3(s) &= 0. \end{aligned}$$

Expressing  $\mathbf{I}_2(s) = \mathbf{I}_1(s) - \mathbf{I}_3(s)$  from the last equation and substituting this into the first two equations, we get

$$\begin{aligned} (0.005s + 10)\mathbf{I}_1(s) - 10\mathbf{I}_3(s) &= \frac{50}{s} \\ -10\mathbf{I}_1(s) + (0.01s + 30)\mathbf{I}_3(s) &= 0. \end{aligned}$$

Solving this system for, say,  $\mathbf{I}_3(s)$ , we obtain

$$\mathbf{I}_3(s) = \frac{10^7}{s(s^2 + 5 \cdot 10^3s + 4 \cdot 10^6)} = \frac{5}{2s} - \frac{10}{3(s + 1000)} + \frac{5}{6(s + 4000)}.$$

The inverse Laplace transform then yields

$$I_3(t) = \frac{5}{2} - \left(\frac{10}{3}\right)e^{-1000t} + \left(\frac{5}{6}\right)e^{-4000t}.$$

From the second equation in (7.29), we find

$$I_2(t) = \frac{0.01I_3'(t) + 20I_3(t)}{10} = 5 - \left(\frac{10}{3}\right)e^{-1000t} - \left(\frac{5}{3}\right)e^{-4000t}.$$

Finally, the last equation in (7.29) yields

$$I_1(t) = I_2(t) + I_3(t) = \frac{15}{2} - \left(\frac{20}{3}\right)e^{-1000t} - \left(\frac{5}{6}\right)e^{-4000t}.$$

## Chapter 7

### REVIEW PROBLEMS

$$2. \frac{1 - e^{-5(s+1)}}{s+1} - \frac{e^{-5s}}{s}$$

$$4. \frac{4}{(s-3)^2 + 16}$$

$$6. \frac{7(s-2)}{(s-2)^2 + 9} - \frac{70}{(s-7)^2 + 25}$$

$$8. 2s^{-3} + 6s^{-2} - (s-2)^{-1} - 6(s-1)^{-1}$$

$$10. \frac{s}{s^2 + 1} + \frac{e^{-\pi s/2}}{(1+s^2)(1-e^{-\pi s})}$$

$$12. 2e^{2t} \cos(\sqrt{2}t) + \left(\frac{3}{\sqrt{2}}\right) e^{2t} \sin(\sqrt{2}t)$$

$$14. e^{-t} - 3e^{-3t} + 3e^{2t}$$

$$16. \frac{\sin 3t - 3t \cos 3t}{54}$$

$$18. f(t) = \sum_{n=0}^{\infty} \frac{(-1)^n t^{2n}}{n!}; \quad F(s) = \sum_{n=0}^{\infty} \frac{(-1)^n (2n)!}{n!} \frac{1}{s^{2n+1}}$$

$$20. (t-3)e^{-3t}$$

$$22. \left(\frac{10}{13}\right) e^{2t} - \left(\frac{23}{13}\right) \cos 3t + \left(\frac{15}{13}\right) \sin 3t$$

$$24. 6e^t + 4te^t + t^2e^t + 2te^{2t} - 6e^{2t}$$

$$26. (1 + Ct^3) e^{-t}, \text{ where } C \text{ is an arbitrary constant}$$

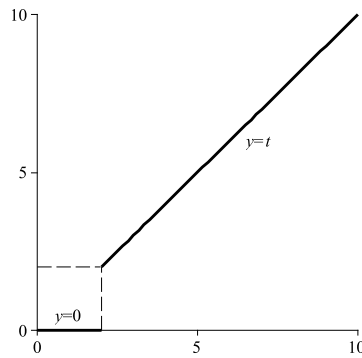
$$28. \left(\frac{3}{2\sqrt{7}}\right) e^{-t/2} \sin\left(\frac{\sqrt{7}t}{2}\right) - \left(\frac{1}{2}\right) e^{-t/2} \cos\left(\frac{\sqrt{7}t}{2}\right) - \frac{1}{2}$$

$$30. \left(\frac{1}{2}\right) \left\{ \sin 2t + \left[ \sin 2\left(t - \frac{\pi}{2}\right) \right] u\left(t - \frac{\pi}{2}\right) \right\}$$

$$32. x = -\frac{1}{2} + \left(\frac{1}{6}\right) e^{2t} + \left(\frac{4}{3}\right) e^{-t} + \left[-\frac{1}{4} + \left(\frac{1}{2}\right)(t-3) - \left(\frac{1}{12}\right)e^{2t-6} - \left(\frac{2}{3}\right)e^{-t+3}\right] u(t-3)$$

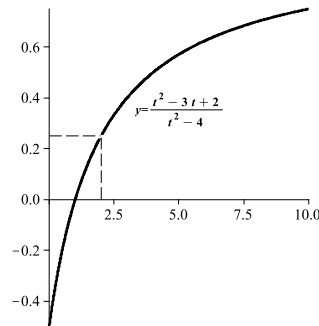
$$y = -\frac{1}{2} - \left(\frac{1}{6}\right) e^{2t} + \left(\frac{2}{3}\right) e^{-t} + \left[\frac{1}{4} + \left(\frac{1}{2}\right)(t-3) + \left(\frac{1}{12}\right)e^{2t-6} - \left(\frac{1}{3}\right)e^{-t+3}\right] u(t-3)$$

**FIGURES**



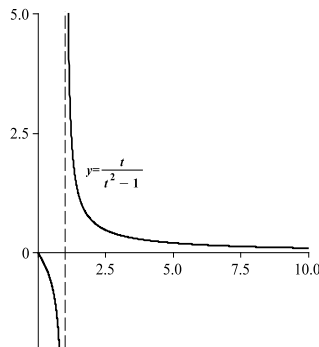
**Figure 7–A:** The graph of  $f(t)$  in Problem 22.

---



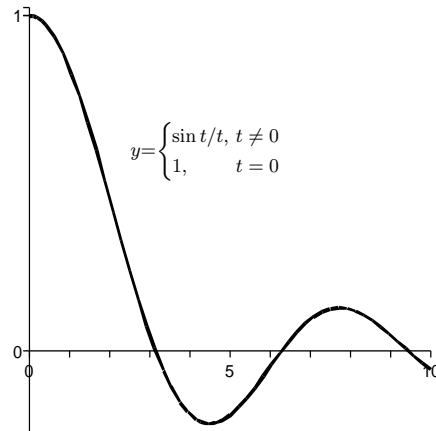
**Figure 7–B:** The graph of  $f(t)$  in Problem 24.

---



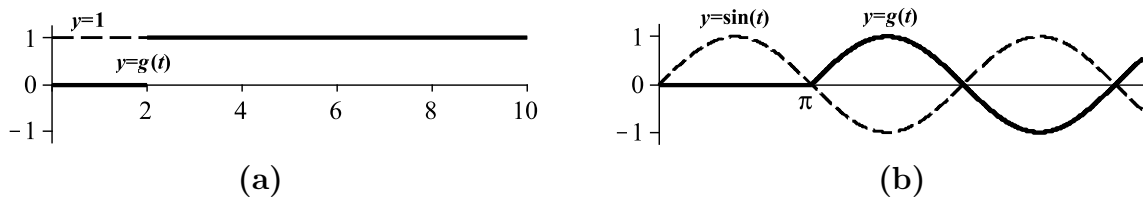
**Figure 7–C:** The graph of  $f(t)$  in Problem 26.

---



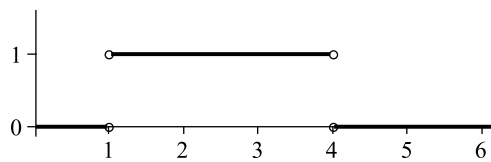
**Figure 7–D:** The graph of  $f(t)$  in Problem 28.

---



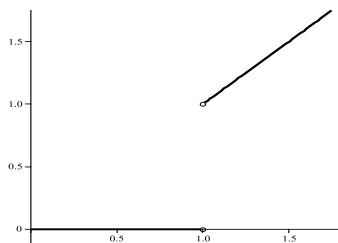
**Figure 7–E:** Graphs of functions  $f(t)$  and  $g(t)$  in Problems 32 and 34.

---



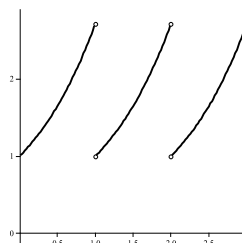
**Figure 7–F:** The graph of the function in Problem 2.

---



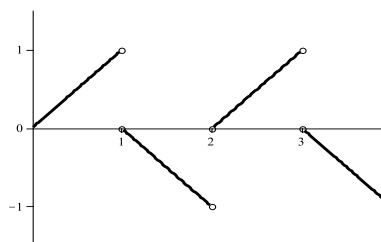
**Figure 7-G:** The graph of the function in Problem 4.

---



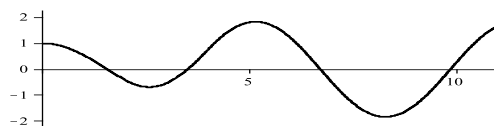
**Figure 7-H:** The graph of  $f(t)$  in Problem 22.

---



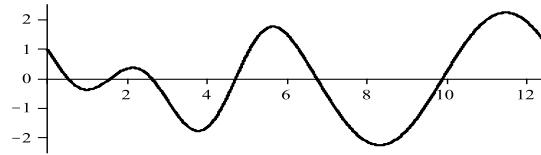
**Figure 7-I:** The graph of  $f(t)$  in Problem 24.

---



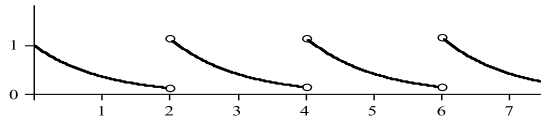
**Figure 7-J:** The graph of  $w(t)$  in Problem 30.

---



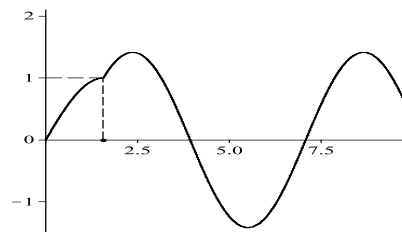
**Figure 7–K:** The graph of  $y(t)$  in Problem 32.

---



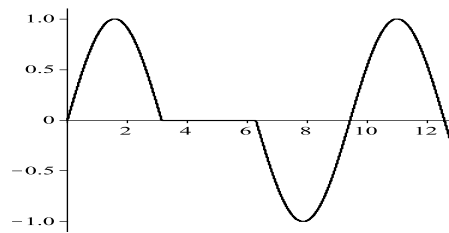
**Figure 7–L:** The graph of  $g(t)$  in Problem 42.

---



**Figure 7–M:** The graph of  $y(t)$  in Problem 22.

---



**Figure 7–N:** The graph of  $y(t)$  in Problem 24.

## CHAPTER 8: Series Solutions of Differential Equations

### EXERCISES 8.1: Introduction: The Taylor Polynomial Approximation

2.  $2 + 4x + 8x^2 + \dots$
4.  $\left(\frac{1}{2}\right)x^2 + \left(\frac{1}{6}\right)x^3 - \left(\frac{1}{20}\right)x^5 + \dots$
6.  $x - \left(\frac{1}{6}\right)x^3 + \left(\frac{1}{120}\right)x^5 + \dots$
8.  $1 - \left(\frac{\sin 1}{2}\right)x^2 + \left(\frac{(\cos 1)(\sin 1)}{24}\right)x^4 + \dots$
10. (a)  $p_3(x) = \frac{1}{2} + \frac{x}{4} + \frac{x^2}{8} + \frac{x^3}{16}$   
(b)  $\varepsilon_3 = \frac{1}{4!} \frac{24}{(2-\xi)^5} \left(\frac{1}{2}\right)^4 \leq \frac{1}{(3/2)^5} \frac{1}{2^4} = \frac{2}{3^5} \approx 0.00823$   
(c)  $\left|\frac{2}{3} - p_3\left(\frac{1}{2}\right)\right| = \frac{1}{384} \approx 0.00260$   
(d) See Fig. 8-A on page 276
12. The differential equation implies that the functions  $y(x)$ ,  $y'(x)$ , and  $y''(x)$  exist and continuous. Furthermore,  $y'''(x)$  can be obtained by differentiating the other terms:  $y''' = -py'' - p'y' - qy' - q'y + g'$ . Since  $p$ ,  $q$ , and  $g$  have derivatives of all orders, subsequent differentiations display the fact that, in turn,  $y'''$ ,  $y^{(4)}$ ,  $y^{(5)}$ , etc. all exist.
14. (a)  $t + \frac{t^2}{2} - \frac{t^3}{6} + \dots$   
(b) For  $r = 1$ ,  $y(t) = 1 - (1/2)t^2 - 4t^4 + \dots$ ;  
For  $r = -1$ ,  $y(t) = 1 + (1/2)t^2 - (49/12)t^4 + \dots$   
(c) For small  $t$  in part (b), the hard spring recoils but the soft spring extends.
16.  $1 - \frac{t^2}{2} + \frac{t^4}{4} + \dots$



## Chapter 8

### EXERCISES 8.2: Power Series and Analytic Functions

2.  $(-\infty, \infty)$

4.  $[2, 4]$

6.  $(-3, -1)$

8. (a)  $\left(-\frac{1}{2}, \frac{1}{2}\right)$

(b)  $\left(-\frac{1}{2}, \frac{1}{2}\right)$

(c)  $(-\infty, \infty)$

(d)  $(-\infty, \infty)$

(e)  $(-\infty, \infty)$

(f)  $\left(-\frac{1}{\sqrt{2}}, \frac{1}{\sqrt{2}}\right)$

10. 
$$\sum_{n=0}^{\infty} \left[ \frac{2^{n+3}}{(n+3)!} + \frac{(n+2)^2}{2^{n+1}} \right] (x-1)^n$$

12.  $x - \left(\frac{2}{3}\right)x^3 + \left(\frac{2}{15}\right)x^5 + \dots$

14. 1

16.  $1 - \left(\frac{1}{2}\right)x + \left(\frac{1}{4}\right)x^2 - \left(\frac{1}{24}\right)x^3 + \dots$

18. 
$$\sum_{k=0}^{\infty} \frac{(-1)^k}{(2k)!} x^{2k} = \cos x$$

20. 
$$\sum_{n=2}^{\infty} n(n-1)a_n x^{n-2}$$

22. 
$$\sum_{k=0}^{\infty} \frac{(-1)^k}{(2k+1)(2k+1)!} x^{2k+1} = x - \frac{x^3}{18} + \frac{x^5}{600} - \dots$$

24. 
$$\sum_{k=4}^{\infty} (k-2)(k-3)a_{k-2} x^k$$

26. 
$$\sum_{k=4}^{\infty} \frac{a_{k-3}}{k} x^k$$

$$30. \sum_{n=0}^{\infty} (-1)^n (x-1)^n$$

$$32. \sum_{n=1}^{\infty} \frac{(-1)^{n+1}}{n} x^n$$

$$34. 1 + \left(\frac{1}{2}\right)(x-1) - \left(\frac{1}{8}\right)(x-1)^2 + \left(\frac{1}{16}\right)(x-1)^3 - \left(\frac{5}{128}\right)(x-1)^4 + \dots$$

36. (a) Always true

(b) Sometimes false

(c) Always true

(d) Always true

$$38. \sum_{n=0}^{\infty} \frac{(-1)^n}{n+1} x^{2n+2} = x^2 - \frac{x^4}{2} + \frac{x^6}{3} - \dots$$

### EXERCISES 8.3: Power Series Solutions to Linear Differential Equations

2. 0

4. -1, 0

6. -1

8. No singular points

10.  $x \leq 1$  and  $x = 2$

$$12. y = a_0 \left( 1 + x + \frac{x^2}{2!} + \frac{x^3}{3!} + \dots \right) = a_0 \sum_{n=0}^{\infty} \frac{x^n}{n!} = a_0 e^x$$

$$14. a_0 \left( 1 - \frac{x^2}{2} + \dots \right) + a_1 \left( x - \frac{x^3}{6} + \dots \right)$$

$$16. a_0 \left( 1 - \frac{x^2}{2} - \frac{x^3}{3} + \dots \right) + a_1 \left( x + x^2 + \frac{x^3}{2} + \dots \right) = a_0 e^x + (a_1 - a_0) x e^x$$

$$18. a_0 \left( 1 + \frac{x^2}{6} + \dots \right) + a_1 \left( x + \frac{x^3}{27} + \dots \right)$$

$$20. a_0 \sum_{k=0}^{\infty} (-1)^k \frac{x^{2k}}{(2k)!} + a_1 \sum_{k=0}^{\infty} (-1)^k \frac{x^{2k+1}}{(2k+1)!} = a_0 \cos x + a_1 \sin x$$

## Chapter 8

22.  $a_{3k+2} = 0, k = 0, 1, \dots$

$$a_0 \left( 1 + \sum_{k=1}^{\infty} (-1)^k \frac{1 \cdot 4 \cdots (3k-5)(3k-2)}{(3k)!} x^{3k} \right) + a_1 \left( x + \sum_{k=1}^{\infty} (-1)^k \frac{2 \cdot 5 \cdots (3k-4)(3k-1)}{(3k+1)!} x^{3k+1} \right)$$

24.  $a_0 \left[ 1 - \frac{x^2}{2} + \frac{x^4}{24} + \sum_{k=3}^{\infty} \frac{(-1)^k (2k-3)^2 (2k-5)^2 \cdots 3^2}{(2k)!} x^{2k} \right] + a_1 x$

26.  $x + \frac{x^2}{2} + \frac{x^3}{2} + \frac{x^4}{3} + \dots$

28.  $-1 - \frac{x^2}{2} - \frac{x^3}{3} - \frac{x^4}{8} + \dots$

30.  $-1 + x + \frac{5x^2}{2} - \frac{x^3}{6}$

32. (a) If  $a_1 = 0$ , then  $y(x)$  is an even function;

(d)  $a_0 = 0, a_1 > 0$

36.  $3 - \frac{9t^2}{2} + t^3 + t^4 + \dots$

### EXERCISES 8.4: Equations with Analytic Coefficients

2. Infinite

4. 2

6. 1

8.  $a_0 \left[ 1 - 2(x+1) + 3(x+1)^2 - \frac{10}{3}(x+1)^3 + \dots \right]$

10.  $a_0 \left[ 1 - \frac{1}{4}(x-2)^2 - \frac{1}{24}(x-2)^3 + \dots \right] + a_1 \left[ (x-2) + \frac{1}{4}(x-2)^2 - \frac{1}{12}(x-2)^3 + \dots \right]$

12.  $a_0 \left[ 1 + \frac{1}{2}(x+1)^2 + \frac{2}{3}(x+1)^3 + \dots \right] + a_1 \left[ (x+1) + 2(x+1)^2 + \frac{7}{3}(x+1)^3 + \dots \right]$

14.  $1 + x + x^2 + \frac{5x^3}{6} + \dots$

16.  $-t + \frac{t^3}{3} + \frac{t^4}{12} + \frac{t^5}{24} + \dots$

$$18. 1 + \left(x - \frac{\pi}{2}\right) + \frac{1}{2} \left(x - \frac{\pi}{2}\right)^2 - \frac{1}{24} \left(x - \frac{\pi}{2}\right)^4 + \dots$$

$$22. a_0 \left(1 - \frac{x^2}{2} + \dots\right) + \left(x + \frac{x^2}{2} - \frac{x^3}{6} + \dots\right)$$

$$24. a_0 \left(1 - \frac{3x^2}{2} + \dots\right) + a_1 \left(x - \frac{x^3}{6} + \dots\right) + \left(\frac{2}{3} - x^2\right)$$

$$26. a_0 (1 - x^2) + a_1 \left(x - \frac{x^3}{6} + \dots\right) + \left(\frac{x^2}{2} + \dots\right)$$

$$28. a_0 \left(1 + \frac{x^3}{6} + \dots\right) + a_1 (x + \dots) + \left(\frac{x^2}{2} + \dots\right)$$

$$30. 1 - \frac{t^2}{2} + \frac{t^3}{2} - \frac{t^4}{4} + \dots$$

### EXERCISES 8.5: Cauchy-Euler (Equidimensional) Equations Revisited

$$2. c_1 x^{-5/2} + c_2 x^{-3}$$

$$4. c_1 x^{-(1+\sqrt{13})/2} + c_2 x^{-(1-\sqrt{13})/2}$$

$$6. c_1 x \cos(\sqrt{3} \ln x) + c_2 x \sin(\sqrt{3} \ln x)$$

$$8. c_1 + c_2 x^{-1/2} \cos\left(\frac{\sqrt{5}}{2} \ln x\right) + c_3 x^{-1/2} \sin\left(\frac{\sqrt{5}}{2} \ln x\right)$$

$$10. c_1 x^{-2} + c_2 x^{-2} \ln x + c_3 x^{-2} (\ln x)^2$$

$$12. c_1 (x+2)^{1/2} \cos[\ln(x+2)] + c_2 (x+2)^{1/2} \sin[\ln(x+2)]$$

$$14. c_1 x + c_2 x^{-1/2} + x \ln x - 2x^{-2} \ln x$$

$$16. 3x^{-2} + 13x^{-2} \ln x$$

### EXERCISES 8.6: Method of Frobenius

2. 0 is regular

4. 0 is regular

6.  $\pm 2$  are regular

## Chapter 8

8. 0, 1 are regular

10. 0, 1 are regular

12.  $r^2 + 3r + 2 = 0$ ;  $r_1 = -1$ ,  $r_2 = -2$

14.  $r^2 - r = 0$ ;  $r_1 = 1$ ,  $r_2 = 0$

16.  $r^2 - \frac{5r}{4} - \frac{3}{4} = 0$ ;  $r_1 = \frac{5 + \sqrt{73}}{8}$ ,  $r_2 = \frac{5 - \sqrt{73}}{8}$

18.  $r^2 - r - \frac{3}{4} = 0$ ;  $r_1 = \frac{3}{2}$ ,  $r_2 = -\frac{1}{2}$

20.  $a_0 \left( 1 - \frac{x}{3} - \frac{x^2}{15} - \frac{x^3}{35} + \dots \right)$

22.  $a_0 \left( 1 + 4x + 4x^2 + \frac{16x^3}{9} + \dots \right)$

24.  $a_0 \left( x^{1/3} + \frac{x^{4/3}}{3} + \frac{x^{7/3}}{18} + \frac{x^{10/3}}{162} + \dots \right)$

26.  $a_0 \sum_{n=0}^{\infty} \frac{(-1)^n x^{n+1}}{n!} = a_0 x e^{-x}$

28.  $a_0 \left[ x^{1/3} + \sum_{n=1}^{\infty} \frac{(-1)^n x^{n+1/3}}{n! \cdot 10 \cdot 13 \cdot \dots \cdot (3n+7)} \right]$

30.  $a_0 \left( 1 + \frac{4x}{5} + \frac{x^2}{5} \right)$

32.  $a_0 \sum_{n=0}^{\infty} \frac{x^{n+1}}{n!} = a_0 x e^x$ ; yes,  $a_0 < 0$

34.  $a_0 \left( 1 + \frac{x}{2} \right)$ ; yes,  $a_0 < 0$

36.  $a_0 \left( x + \frac{x^2}{20} + \frac{x^3}{1960} + \frac{x^4}{529200} + \dots \right)$

38.  $a_0 \left( x^{5/6} + \frac{31x^{11/6}}{726} + \frac{2821x^{17/6}}{2517768} + \frac{629083x^{23/6}}{23974186896} + \dots \right)$

40.  $a_0 (1 + 2x + 2x^2)$

42. The transformed equation is

$$18z(4z-1)^2(6z-1)\frac{d^2y}{dz^2} + 9(4z-1)(96z^2-40z+3)\frac{dy}{dz} + 32y = 0, \text{ so that}$$

$$zp(z) = \frac{96z^2 - 40z + 3}{2(4z-1)(6z-1)} \quad \text{and} \quad z^2q(z) = \frac{16z}{9(4z-1)^2(6z-1)}$$

are analytic at  $z = 0$ . Hence,  $z = 0$  is a regular singular point.

$$y_1(x) = a_0 \left( 1 + \frac{32}{27}x^{-1} + \frac{1600}{243}x^{-2} + \frac{241664}{6561}x^{-3} + \dots \right)$$

### EXERCISES 8.7: Finding a Second Linearly Independent Solution

2.  $c_1y_1(x) + c_2y_2(x)$ , where  $y_1(x) = 1 - \frac{x}{3} - \frac{x^2}{15} + \dots$  and  $y_2(x) = x^{-1/2} - x^{1/2}$

4.  $c_1y_1(x) + c_2y_2(x)$ , where

$$y_1(x) = 1 + 4x + 4x^2 + \dots \quad \text{and} \quad y_2(x) = y_1(x) \ln x - 8x - 12x^2 - \frac{176x^3}{27} + \dots$$

6.  $c_1 \left( x^{1/3} + \frac{x^{4/3}}{3} + \frac{x^{7/3}}{18} + \dots \right) + c_2 \left( 1 + \frac{x}{2} + \frac{x^2}{10} + \dots \right)$

8.  $c_1y_1(x) + c_2y_2(x)$ , where

$$y_1(x) = x - x^2 + \frac{x^3}{2} + \dots \quad \text{and} \quad y_2(x) = y_1(x) \ln x + x^2 - \frac{3x^3}{4} - \frac{11x^4}{36} + \dots$$

10.  $c_1 \left( x^{1/3} - \frac{x^{4/3}}{10} + \frac{x^{7/3}}{260} + \dots \right) + c_2 \left( \frac{1}{x^2} + \frac{1}{4x} + \frac{1}{8} + \dots \right)$

12.  $c_1y_1(x) + c_2y_2(x)$ , where  $y_1(x) = 1 + \frac{4x}{5} + \frac{x^2}{5}$  and  $y_2(x) = x^{-4} + 4x^{-3} + 5x^{-2}$

14.  $c_1y_1(x) + c_2y_2(x)$ , where

$$y_1(x) = x + x^2 + \frac{x^3}{2} + \dots \quad \text{and} \quad y_2(x) = y_1(x) \ln x - x^2 - \frac{3x^3}{4} - \frac{11x^4}{36} + \dots$$

16.  $c_1 \left( 1 + \frac{x}{2} \right) + c_2 \left( -\frac{1}{x} - x \ln x - 2 \ln x - \frac{1}{2} + \frac{9x}{4} + \dots \right)$ ; has a bounded solution near the origin, but not all solutions are bounded near the origin

18.  $c_1y_1(x) + c_2y_2(x) + c_3y_3(x)$ , where

$$y_1(x) = x + \frac{x^2}{20} + \frac{x^3}{1960} + \dots, \quad y_2(x) = x^{2/3} + \frac{3x^{5/3}}{26} + \frac{9x^{8/3}}{4940} + \dots \quad \text{and}$$

$$y_3(x) = x^{-1/2} + 2x^{1/2} + \frac{2x^{3/2}}{5} + \dots$$

## Chapter 8

20.  $c_1y_1(x) + c_2y_2(x) + c_3y_3(x)$ , where

$$y_1(x) = x^{5/6} + \frac{31x^{11/6}}{726} + \frac{2821x^{17/6}}{2517768} + \cdots, \quad y_2(x) = 1 + x + \frac{x^2}{28} + \cdots \quad \text{and}$$

$$y_3(x) = y_2 \ln x - 9x - \frac{3x^2}{98} + \frac{437x^3}{383292} + \cdots$$

22.  $c_1y_1(x) + c_2y_2(x)$ , where

$$y_1(x) = x - \frac{\alpha^2 x^2}{2} + \frac{\alpha^4 x^3}{12} - \frac{\alpha^6 x^4}{144} + \cdots \quad \text{and}$$

$$y_2(x) = -\alpha^2 y_1(x) \ln x + 1 + \alpha^2 x - \frac{5\alpha^4 x^2}{4} + \frac{5\alpha^6 x^3}{18} + \cdots$$

26. (d)  $a_1 = -\frac{2+i}{5}$ ,  $a_2 = \frac{2+i}{20}$

### EXERCISES 8.8: Special Functions

2.  $c_1 F\left(3, 5; \frac{1}{3}; x\right) + c_2 x^{2/3} F\left(\frac{11}{3}, \frac{17}{3}; \frac{5}{3}; x\right)$

4.  $c_1 F\left(1, 3; \frac{3}{2}; x\right) + c_2 x^{-1/2} F\left(\frac{1}{2}, \frac{5}{2}; \frac{1}{2}; x\right)$

6.  $F(\alpha, \beta; \beta; x) = \sum_{n=0}^{\infty} (\alpha)_n \frac{x^n}{n!} = (1-x)^{-\alpha}$

8.  $F\left(\frac{1}{2}, 1; \frac{3}{2}; -x^2\right) = \sum_{n=0}^{\infty} (-1)^n \frac{x^{2n}}{2n+1} = x^{-1} \arctan x$

10.  $y_1(x) = F\left(\frac{1}{2}, \frac{1}{2}; 2; x\right) = 1 + \frac{x}{8} + \frac{3x^2}{64} + \frac{25x^3}{1024} + \cdots$  and

$$y_2(x) = y_1(x) \ln x + \frac{4}{x} + \frac{5x}{16} + \frac{x^2}{8} + \cdots$$

14.  $c_1 J_{4/3}(x) + c_2 J_{-4/3}(x)$

16.  $c_1 J_0(x) + c_2 Y_0(x)$

18.  $c_1 J_4(x) + c_2 Y_4(x)$

20.  $J_2(x) \ln x - \frac{2}{x^2} - \frac{1}{2} - \frac{3x^2}{16} + \frac{17x^4}{1152} + \cdots$

26.  $J_{-3/2}(x) = -x^{-1} J_{-1/2}(x) - J_{1/2}(x) = -\sqrt{\frac{2}{\pi}} x^{-3/2} \cos x - \sqrt{\frac{2}{\pi}} x^{-1/2} \sin x$

$$J_{5/2}(x) = \frac{3-x^2}{x^2} J_{1/2}(x) - \frac{3}{x} J_{-1/2}(x) = 3\sqrt{\frac{2}{\pi}} x^{-5/2} \sin x - 3\sqrt{\frac{2}{\pi}} x^{-3/2} \cos x - \sqrt{\frac{2}{\pi}} x^{-1/2} \sin x$$

36.  $y_1(x) = x$  and  $y_2(x) = 1 - \sum_{k=1}^{\infty} \frac{x^{2k}}{2k-1}$

38.  $2x^2 - 1, 4x^3 - 3x, 8x^4 - 8x^2 + 1$

40.  $c_1 J_{1/(n+2)} \left( \frac{2\sqrt{c}}{n+2} x^{(n/2)+1} \right) + c_2 Y_{1/(n+2)} \left( \frac{2\sqrt{c}}{n+2} x^{(n/2)+1} \right)$

## REVIEW PROBLEMS

2. (a)  $\pm 2$  are irregular singular points

(b)  $n\pi$ , where  $n$  is an integer, are regular singular points

4. (a)  $a_0 \left( 1 + \sum_{k=1}^{\infty} \frac{(-3)(-1)(1)\cdots(2k-5)}{2^k k!} x^{2k} \right) + a_1 \left( x - \frac{2x^3}{3} \right)$

(b)  $a_0 \left( 1 + \sum_{k=1}^{\infty} \frac{3 \cdot 5 \cdot 15 \cdots (4k^2 - 10k + 9)}{2^k (2k)!} x^{2k} \right) + a_1 \left( x + \sum_{k=1}^{\infty} \frac{3 \cdot 9 \cdot 23 \cdots (4k^2 - 6k + 5)}{2^k (2k+1)!} x^{2k+1} \right)$

6. (a)  $c_1 x^{(-3+\sqrt{105})/4} + c_2 x^{(-3-\sqrt{105})/4}$

(b)  $c_1 x^{-1} + c_2 x^{-1} \ln x + c_3 x^2$

8. (a)  $y_1(x) = \sum_{n=0}^{\infty} a_n x^{n+2}$  and  $y_2(x) = y_1(x) \ln x + \sum_{n=0}^{\infty} b_n x^{n-2}$

(b)  $y_1(x) = \sum_{n=0}^{\infty} a_n x^n$  and  $y_2(x) = \sum_{n=0}^{\infty} b_n x^{n-(3/2)}$

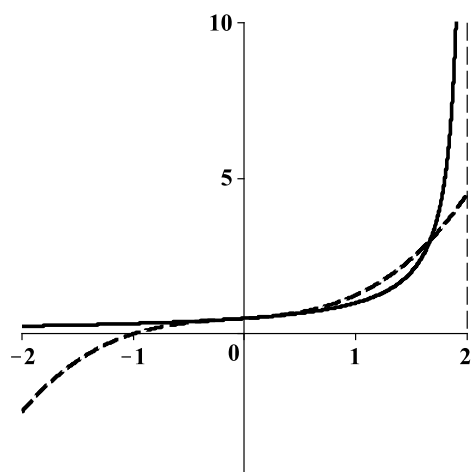
(c)  $y_1(x) = \sum_{n=0}^{\infty} a_n x^n$  and  $y_2(x) = y_1(x) \ln x + \sum_{n=1}^{\infty} b_n x^n$

10. (a)  $c_1 F \left( 3, 2; \frac{1}{2}; x \right) + c_2 x^{1/2} F \left( \frac{7}{2}, \frac{5}{2}; \frac{3}{2}; x \right)$

(b)  $c_1 J_{1/3}(\theta) + c_2 J_{-1/3}(\theta)$



FIGURES



**Figure 8–A:** The graphs of  $f(x) = 1/(2 - x)$  and its Taylor polynomial  $p_3(x)$

---

## CHAPTER 9: Matrix Methods for Linear Systems

### EXERCISES 9.1: Introduction

$$2. \begin{bmatrix} x \\ y \end{bmatrix}' = \begin{bmatrix} 0 & 1 \\ -1 & 0 \end{bmatrix} \begin{bmatrix} x \\ y \end{bmatrix}$$

$$4. \begin{bmatrix} x_1 \\ x_2 \\ x_3 \\ x_4 \end{bmatrix}' = \begin{bmatrix} 1 & -1 & 1 & -1 \\ 1 & 0 & 0 & 1 \\ \sqrt{\pi} & 0 & -1 & 0 \\ 0 & 0 & 0 & 0 \end{bmatrix} \begin{bmatrix} x_1 \\ x_2 \\ x_3 \\ x_4 \end{bmatrix}$$

$$6. \begin{bmatrix} x_1 \\ x_2 \\ x_3 \end{bmatrix}' = \begin{bmatrix} \cos 2t & 0 & 0 \\ 0 & \sin 2t & 0 \\ 1 & -1 & 0 \end{bmatrix} \begin{bmatrix} x_1 \\ x_2 \\ x_3 \end{bmatrix}$$

$$8. \begin{bmatrix} x_1 \\ x_2 \end{bmatrix}' = \begin{bmatrix} 0 & 1 \\ -2/(1-t^2) & 2t/(1-t^2) \end{bmatrix} \begin{bmatrix} x_1 \\ x_2 \end{bmatrix}$$

$$10. \begin{bmatrix} x_1 \\ x_2 \end{bmatrix}' = \begin{bmatrix} 0 & 1 \\ -1 + n^2/t^2 & -1/t \end{bmatrix} \begin{bmatrix} x_1 \\ x_2 \end{bmatrix}$$

$$12. \begin{bmatrix} x_1 \\ x_2 \\ x_3 \\ x_4 \end{bmatrix}' = \begin{bmatrix} 0 & 1 & 0 & 0 \\ 0 & -3 & -2 & 1 \\ 0 & 0 & 0 & 1 \\ 0 & -1 & -1 & -3 \end{bmatrix} \begin{bmatrix} x_1 \\ x_2 \\ x_3 \\ x_4 \end{bmatrix}$$

### EXERCISES 9.2: Review 1: Linear Algebraic Equations

$$2. x_1 = 0, x_2 = \frac{1}{3}, x_3 = \frac{2}{3}, x_4 = 0$$

$$4. x_1 = \frac{1}{3}, x_2 = \frac{2}{3}, x_3 = 0, x_4 = 0$$

$$6. x_1 = -\frac{s}{4}, x_2 = \frac{s}{4}, x_3 = s \quad (-\infty < s < \infty)$$

## Chapter 9

8.  $x_1 = -s + t, x_2 = s, x_3 = t$  ( $-\infty < s, t < \infty$ )

10.  $x_1 = \frac{-2+i}{5}, x_2 = 0, x_3 = \frac{2+4i}{5}$

12. (a) The equation produce the format

$$\begin{aligned}x_1 - \frac{1}{2}x_2 &= 0, \\ 0 &= 1\end{aligned}$$

(b) The equation produce the format

$$\begin{aligned}x_1 + \frac{1}{2}x_3 &= 0, \\ x_2 + \frac{11}{3}x_3 &= 0, \\ 0 &= 1\end{aligned}$$

14. For  $r = -1$ , the unique solution is  $x_1 = x_2 = x_3 = 0$ .

For  $r = 2$ , the solutions are  $x_1 = -\frac{s}{2}, x_2 = \frac{s}{4}, x_3 = s$  ( $-\infty < s < \infty$ ).

### EXERCISES 9.3: Review 2: Matrices and Vectors

2. (a)  $\mathbf{A} + \mathbf{B} = \begin{bmatrix} 3 & -1 & 7 \\ 2 & 4 & -1 \end{bmatrix}$

(b)  $7\mathbf{A} - 4\mathbf{B} = \begin{bmatrix} 10 & 4 & 27 \\ 14 & -5 & 15 \end{bmatrix}$

4. (a)  $\mathbf{AB} = \begin{bmatrix} 2 & 5 & -1 \\ 0 & 12 & 4 \\ -1 & 8 & 4 \end{bmatrix}$

(b)  $\mathbf{BA} = \begin{bmatrix} 3 & 2 \\ -1 & 15 \end{bmatrix}$

6. (a)  $\mathbf{AB} = \begin{bmatrix} 2 & 7 \\ 1 & 5 \end{bmatrix}$

(b)  $(\mathbf{AB})\mathbf{C} = \begin{bmatrix} 9 & -1 \\ 6 & 1 \end{bmatrix}$

(c)  $(\mathbf{A} + \mathbf{B})\mathbf{C} = \begin{bmatrix} 6 & 1 \\ 5 & -5 \end{bmatrix}$

$$10. \begin{bmatrix} \frac{9}{31} & -\frac{1}{31} \\ -\frac{5}{31} & \frac{4}{31} \end{bmatrix}$$

$$12. \begin{bmatrix} 1 & 0 & -1 \\ 1 & -1 & 2 \\ 1 & -1 & 1 \end{bmatrix}$$

$$14. \begin{bmatrix} 1 & \frac{1}{2} & -\frac{1}{2} \\ \frac{1}{3} & -\frac{1}{2} & \frac{1}{6} \\ -\frac{1}{3} & 0 & \frac{1}{3} \end{bmatrix}$$

$$16. \text{ (c) } x = \begin{bmatrix} 2 \\ 1 \\ 0 \end{bmatrix} + c \begin{bmatrix} -1 \\ -1 \\ 1 \end{bmatrix}, \text{ with } c \text{ arbitrary}$$

$$18. \begin{bmatrix} \sin 2t & \frac{1}{2} \cos 2t \\ \cos 2t & -\frac{1}{2} \sin 2t \end{bmatrix}$$

$$20. \begin{bmatrix} 0 & 0 & \left(\frac{1}{9}\right) e^{-3t} \\ 1 & -t & \left(\frac{1}{3}\right) t - \frac{1}{9} \\ 0 & 1 & -\frac{1}{3} \end{bmatrix}$$

$$22. 0$$

$$24. 11$$

$$26. 54$$

$$28. 1, 6$$

## Chapter 9

30. (b) 0

$$(c) \quad x = c \begin{bmatrix} 1 \\ 1 \\ -1 \end{bmatrix}$$

$$(d) \quad c_1 = c_2 = c_3 = -1$$

$$32. \quad \begin{bmatrix} 3e^{-t} \cos 3t - e^{-t} \sin 3t \\ -3e^{-t} \cos 3t + e^{-t} \sin 3t \end{bmatrix}$$

$$34. \quad \begin{bmatrix} 2 \cos 2t & -2 \sin 2t & -2e^{-2t} \\ -2 \cos 2t & -4 \sin 2t & -6e^{-2t} \\ 6 \cos 2t & -2 \sin 2t & -2e^{-2t} \end{bmatrix}$$

$$40. (a) \quad \begin{bmatrix} t & -\left(\frac{1}{2}\right)e^{-2t} \\ 3t & -\left(\frac{1}{2}\right)e^{-2t} \end{bmatrix} + \begin{bmatrix} c_{11} & c_{12} \\ c_{21} & c_{22} \end{bmatrix}$$

$$(b) \quad \begin{bmatrix} -e^{-1} + 1 & -e^{-1} + 1 \\ e^{-1} - 1 & -3e^{-1} + 3 \end{bmatrix}$$

$$(c) \quad \begin{bmatrix} -e^{-t} + 3e^{-3t} & -3e^{-t} - 9e^{-3t} \\ -3e^{-t} + 3e^{-3t} & -3e^{-t} - 9e^{-3t} \end{bmatrix}$$

42. In general,  $(\mathbf{A}\mathbf{B})^T = \mathbf{B}^T \mathbf{A}^T$ . Thus,  $(\mathbf{A}^T \mathbf{A})^T = \mathbf{A}^T (\mathbf{A}^T)^T = \mathbf{A}^T \mathbf{A}$ , so  $\mathbf{A}^T \mathbf{A}$  is symmetric. Similarly, one shows that  $\mathbf{A}\mathbf{A}^T$  is symmetric

### EXERCISES 9.4: Linear Systems in Normal Form

$$2. \quad \begin{bmatrix} r'(t) \\ \theta'(t) \end{bmatrix} = \begin{bmatrix} 2 & 0 \\ 1 & -1 \end{bmatrix} \begin{bmatrix} r(t) \\ \theta(t) \end{bmatrix} + \begin{bmatrix} \sin t \\ 1 \end{bmatrix}$$

$$4. \quad \begin{bmatrix} \frac{dx}{dt} \\ \frac{dy}{dt} \\ \frac{dz}{dt} \end{bmatrix} = \begin{bmatrix} 1 & 1 & 1 \\ 2 & -1 & 3 \\ 1 & 0 & 5 \end{bmatrix} \begin{bmatrix} x \\ y \\ z \end{bmatrix}$$

$$6. \begin{bmatrix} x_1'(t) \\ x_2'(t) \end{bmatrix} = \begin{bmatrix} 0 & 1 \\ -1 & 0 \end{bmatrix} \begin{bmatrix} x_1(t) \\ x_2(t) \end{bmatrix} + \begin{bmatrix} 0 \\ t^2 \end{bmatrix}$$

$$8. \begin{bmatrix} x_1'(t) \\ x_2'(t) \\ x_3'(t) \end{bmatrix} = \begin{bmatrix} 0 & 1 & 0 \\ 0 & 0 & 1 \\ -1 & 1 & 0 \end{bmatrix} \begin{bmatrix} x_1(t) \\ x_2(t) \\ x_3(t) \end{bmatrix} + \begin{bmatrix} 0 \\ 0 \\ \cos t \end{bmatrix}$$

$$10. x_1'(t) = 2x_1(t) + x_2(t) + te^t;$$

$$x_2'(t) = -x_1(t) + 3x_2(t) + e^t$$

$$12. x_1'(t) = x_2(t) + t + 3;$$

$$x_2'(t) = x_3(t) - t + 1;$$

$$x_3'(t) = -x_1(t) + x_2(t) + 2x_3(t) + 2t$$

14. Linearly independent

16. Linearly dependent

18. Linearly independent

$$20. \text{ Yes. } \begin{bmatrix} 3e^{-t} & e^{4t} \\ 2e^{-t} & -e^{4t} \end{bmatrix}; c_1 \begin{bmatrix} 3e^{-t} \\ 2e^{-t} \end{bmatrix} + c_2 \begin{bmatrix} e^{4t} \\ -e^{4t} \end{bmatrix}$$

22. Linearly independent; fundamental matrix is

$$\begin{bmatrix} e^t & \sin t & -\cos t \\ e^t & \cos t & \sin t \\ e^t & -\sin t & \cos t \end{bmatrix}$$

The general solution is

$$c_1 \begin{bmatrix} e^t \\ e^t \\ e^t \end{bmatrix} + c_2 \begin{bmatrix} \sin t \\ \cos t \\ -\sin t \end{bmatrix} + c_3 \begin{bmatrix} -\cos t \\ \sin t \\ \cos t \end{bmatrix}$$

$$24. c_1 \begin{bmatrix} e^{3t} \\ 0 \\ e^{3t} \end{bmatrix} + c_2 \begin{bmatrix} -e^{3t} \\ e^{3t} \\ 0 \end{bmatrix} + c_3 \begin{bmatrix} -e^{-3t} \\ -e^{-3t} \\ e^{-3t} \end{bmatrix} + \begin{bmatrix} 5t + 1 \\ 2t \\ 4t + 2 \end{bmatrix}$$

## Chapter 9

$$28. \mathbf{X}^{-1}(t) = \begin{bmatrix} \left(\frac{1}{2}\right)e^t & -\left(\frac{1}{2}\right)e^t \\ \left(\frac{1}{2}\right)e^{-5t} & \left(\frac{1}{2}\right)e^{-5t} \end{bmatrix};$$

$$\mathbf{x}(t) = \begin{bmatrix} 2e^{-t} + e^{5t} \\ -2e^{-t} + e^{5t} \end{bmatrix}$$

32. Choosing  $\mathbf{x}_0 = \text{col}(1, 0, 0, \dots, 0)$ , then  $\mathbf{x}_1 = \text{col}(0, 1, 0, \dots, 0)$ , and so on, the corresponding solutions  $\mathbf{x}_1, \mathbf{x}_2, \dots, \mathbf{x}_n$  will have a nonvanishing Wronskian at the initial point  $t_0$ . Hence,  $\{\mathbf{x}_1, \mathbf{x}_2, \dots, \mathbf{x}_n\}$  is a fundamental solution set

### EXERCISES 9.5: Homogeneous Linear Systems with Constant Coefficients

2. Eigenvalues are  $r_1 = 3$  and  $r_2 = 4$  with associated eigenvectors

$$\mathbf{u}_1 = s \begin{bmatrix} 1 \\ 1 \end{bmatrix} \text{ and } \mathbf{u}_2 = s \begin{bmatrix} 3 \\ 2 \end{bmatrix}$$

4. Eigenvalues are  $r_1 = -4$  and  $r_2 = 2$  with associated eigenvectors

$$\mathbf{u}_1 = s \begin{bmatrix} 1 \\ -1 \end{bmatrix} \text{ and } \mathbf{u}_2 = s \begin{bmatrix} 5 \\ 1 \end{bmatrix}$$

6. Eigenvalues are  $r_1 = r_2 = -1$  and  $r_3 = 2$  with associated eigenvectors

$$\mathbf{u}_1 = s \begin{bmatrix} -1 \\ 1 \\ 0 \end{bmatrix}, \mathbf{u}_2 = \nu \begin{bmatrix} -1 \\ 0 \\ 1 \end{bmatrix}, \text{ and } \mathbf{u}_3 = s \begin{bmatrix} 1 \\ 1 \\ 1 \end{bmatrix}$$

8. Eigenvalues are  $r_1 = -1$  and  $r_2 = -2$  with associated eigenvectors

$$\mathbf{u}_1 = s \begin{bmatrix} 1 \\ 2 \\ 4 \end{bmatrix} \text{ and } \mathbf{u}_2 = s \begin{bmatrix} 1 \\ 1 \\ 1 \end{bmatrix}$$

10. Eigenvalues are  $r_1 = 1$ ,  $r_2 = 1 + i$ , and  $r_3 = 1 - i$  with associated eigenvectors

$$\mathbf{u}_1 = s \begin{bmatrix} 1 \\ 0 \\ 0 \end{bmatrix}, \mathbf{u}_2 = s \begin{bmatrix} -1 - 2i \\ 1 \\ i \end{bmatrix}, \text{ and } \mathbf{u}_3 = s \begin{bmatrix} -1 + 2i \\ 1 \\ -i \end{bmatrix},$$

where  $s$  is any complex constant

$$12. c_1 e^{7t} \begin{bmatrix} 1 \\ 2 \end{bmatrix} + c_2 e^{-5t} \begin{bmatrix} 1 \\ -2 \end{bmatrix}$$

$$14. c_1 e^{-t} \begin{bmatrix} -1 \\ 0 \\ 1 \end{bmatrix} + c_2 e^{-2t} \begin{bmatrix} 1 \\ -1 \\ 3 \end{bmatrix} + c_3 e^{3t} \begin{bmatrix} 1 \\ 4 \\ 3 \end{bmatrix}$$

$$16. c_1 e^{-10t} \begin{bmatrix} 2 \\ 0 \\ -1 \end{bmatrix} + c_2 e^{5t} \begin{bmatrix} 0 \\ 1 \\ 0 \end{bmatrix} + c_3 e^{5t} \begin{bmatrix} 1 \\ 0 \\ 2 \end{bmatrix}$$

18. (a) Eigenvalues are  $r_1 = -1$  and  $r_2 = -3$  with associated eigenvectors

$$\mathbf{u}_1 = s \begin{bmatrix} 1 \\ 1 \end{bmatrix} \quad \text{and} \quad \mathbf{u}_2 = s \begin{bmatrix} 1 \\ -1 \end{bmatrix}$$

$$(b) \begin{cases} x_1 = e^{-t} \\ x_2 = e^{-t} \end{cases} \quad (c) \begin{cases} x_1 = -e^{-3t} \\ x_2 = e^{-3t} \end{cases} \quad (d) \begin{cases} x_1 = e^{-t} - e^{-3t} \\ x_2 = e^{-t} + e^{-3t} \end{cases}$$

See Figures 9–A, 9–B, and 9–C on page 290.

$$20. \begin{bmatrix} e^t & 4e^{4t} \\ -e^t & -e^{4t} \end{bmatrix}$$

$$22. \begin{bmatrix} e^{2t} & -e^{2t} & e^t \\ 0 & e^{2t} & e^t \\ e^{2t} & 0 & 3e^t \end{bmatrix}$$

$$24. \begin{bmatrix} 1 & e^{4t} & 0 & 0 \\ 4 & 0 & 0 & 0 \\ 0 & 0 & 3e^t & e^{-t} \\ 0 & 0 & e^t & e^{-t} \end{bmatrix}$$

$$26. x(t) = c_1 e^{-5t} + 2c_2 e^t;$$

$$y(t) = 2c_1 e^{-5t} + c_2 e^t$$

$$28. \begin{bmatrix} -0.2931e^{0.4679t} & 0.4491e^{3.8794t} & -0.6527e^{1.6527t} \\ -0.5509e^{0.4679t} & -0.1560e^{3.8794t} & e^{1.6527t} \\ e^{0.4679t} & e^{3.8794t} & -0.7733e^{1.6527t} \end{bmatrix}$$



Chapter 9

$$30. \begin{bmatrix} e^{0.6180t} & -0.6180e^{-1.6180t} & 0 & 0 \\ -0.6180e^{0.6180t} & e^{-1.6180t} & 0 & 0 \\ 0 & 0 & e^{0.5858t} & 0.2929e^{3.4142t} \\ 0 & 0 & 0.5858e^{0.5858t} & e^{3.4142t} \end{bmatrix}$$

$$32. \begin{bmatrix} 2e^{3t} - 12e^{4t} \\ 2e^{3t} - 8e^{4t} \end{bmatrix}$$

$$34. \begin{bmatrix} e^{2t} - 2e^{-t} \\ e^{2t} + 3e^{-t} \\ e^{2t} - e^{-t} \end{bmatrix}$$

$$36. c_1 e^{2t} \begin{bmatrix} 1 \\ 1 \end{bmatrix} + c_2 \left\{ t e^{2t} \begin{bmatrix} 1 \\ 1 \end{bmatrix} + e^{2t} \begin{bmatrix} 4/3 \\ 1 \end{bmatrix} \right\}$$

$$38. c_1 e^t \begin{bmatrix} 1 \\ 1 \\ 0 \end{bmatrix} + c_2 \left\{ t e^t \begin{bmatrix} 1 \\ 1 \\ 0 \end{bmatrix} + e^t \begin{bmatrix} 0 \\ 0 \\ 1 \end{bmatrix} \right\} + c_3 \left\{ \frac{t^2 e^t}{2} \begin{bmatrix} 1 \\ 1 \\ 0 \end{bmatrix} + t e^t \begin{bmatrix} 0 \\ 0 \\ 1 \end{bmatrix} + e^t \begin{bmatrix} -1/4 \\ 0 \\ 1/2 \end{bmatrix} \right\}$$

$$40. c_1 e^t \begin{bmatrix} 1 \\ 0 \\ 0 \end{bmatrix} + c_2 e^t \begin{bmatrix} 0 \\ 2 \\ 3 \end{bmatrix} + c_3 \left\{ t e^t \begin{bmatrix} 1 \\ 2 \\ 3 \end{bmatrix} + e^t \begin{bmatrix} 0 \\ 1 \\ 1 \end{bmatrix} \right\}$$

$$44. c_1 \begin{bmatrix} 1 \\ 2 \end{bmatrix} + c_2 t^{-5} \begin{bmatrix} -2 \\ 1 \end{bmatrix}$$

$$46. x_1(t) = \frac{e^{-3t}}{10} \text{ kg}, x_2(t) = \frac{3-\alpha}{10\alpha} (e^{\alpha t} - 1)e^{-3t} \text{ kg}$$

The mass of salt in tank  $A$  is independent of  $\alpha$ . The maximum mass of salt in tank  $B$

is  $0.1 \left( \frac{3-\alpha}{3} \right)^{3/\alpha} \text{ kg}$

$$50. \text{ (b) } \begin{aligned} x(t) &= 1 + \frac{3}{2}e^{-t} + \frac{1}{2}e^{-3t}; \\ y(t) &= 1 - e^{-3t}; \\ z(t) &= 1 - \frac{3}{2}e^{-t} + \frac{1}{2}e^{-3t} \end{aligned}$$

## EXERCISES 9.6: Complex Eigenvalues

$$2. \quad c_1 \begin{bmatrix} -5 \cos t \\ 2 \cos t - \sin t \end{bmatrix} + c_2 \begin{bmatrix} -5 \sin t \\ 2 \sin t + \cos t \end{bmatrix}$$

$$4. \quad c_1 \begin{bmatrix} 5e^{2t} \cos t \\ -2e^{2t} \cos t + e^{2t} \sin t \\ 5e^{2t} \cos t \end{bmatrix} + c_2 \begin{bmatrix} 5e^{2t} \sin t \\ -2e^{2t} \sin t - e^{2t} \cos t \\ 5e^{2t} \sin t \end{bmatrix} + c_3 \begin{bmatrix} 0 \\ e^{2t} \\ -e^{2t} \end{bmatrix}$$

$$6. \quad \begin{bmatrix} \cos 2t & \sin 2t \\ \sin 2t - \cos 2t & -\sin 2t - \cos 2t \end{bmatrix}$$

$$8. \quad \begin{bmatrix} e^t & e^{-t} & 0 & 0 \\ e^t & e^{-t} & 0 & 0 \\ 0 & 0 & e^{2t} \cos 3t & e^{2t} \sin 3t \\ 0 & 0 & e^{2t}(2 \cos 3t - 3 \sin 3t) & e^{2t}(2 \sin 3t + 3 \cos 3t) \end{bmatrix}$$

$$10. \quad \begin{bmatrix} -0.0209e^{2t} \cos 3t + 0.0041e^{2t} \sin 3t & -0.0209e^{2t} \sin 3t - 0.0041e^{2t} \cos 3t & -e^{-t} & e^t \\ -0.0296e^{2t} \cos 3t + 0.0710e^{2t} \sin 3t & -0.0296e^{2t} \sin 3t - 0.0710e^{2t} \cos 3t & e^{-t} & e^t \\ 0.1538e^{2t} \cos 3t + 0.2308e^{2t} \sin 3t & 0.1538e^{2t} \sin 3t - 0.2308e^{2t} \cos 3t & -e^{-t} & e^t \\ e^{2t} \cos 3t & e^{2t} \sin 3t & -e^{-t} & e^t \end{bmatrix}$$

$$12. \quad \begin{bmatrix} 0 & 0 & 0 & 0 & e^t \\ 0 & 0 & e^{-t} & e^t & 0 \\ 0 & 0 & -e^{-t} & e^t & 0 \\ -0.07e^{-2t} \cos 5t + 0.17e^{-2t} \sin 5t & -0.067e^{-2t} \sin 5t - 0.17e^{-2t} \cos 5t & 0 & 0 & 0 \\ e^{-2t} \cos 5t & e^{-2t} \sin 5t & 0 & 0 & 0 \end{bmatrix}$$

$$14. \quad (\text{a}) \quad \begin{bmatrix} e^t \sin t - 2e^t \cos t \\ 2e^{2t} \\ -e^t \cos t - 2e^t \sin t \end{bmatrix}$$

$$(\text{b}) \quad \begin{bmatrix} e^{t+\pi} \sin t \\ e^{2(t+\pi)} \\ -e^{t+\pi} \cos t \end{bmatrix}$$

$$18. \quad c_1 t^{-1} \begin{bmatrix} \cos(3 \ln t) \\ 3 \sin(3 \ln t) \end{bmatrix} + c_2 t^{-1} \begin{bmatrix} \sin(3 \ln t) \\ -3 \cos(3 \ln t) \end{bmatrix}$$

## Chapter 9

20.  $x_1(t) = \cos t - \cos \sqrt{3}t;$

$$x_2(t) = \cos t + \cos \sqrt{3}t$$

22.  $I_1(t) = \left(\frac{16}{5}\right)e^{-2t} - \left(\frac{1}{5}\right)e^{-8t} + 2;$

$$I_2(t) = 4e^{-2t} - e^{-8t} + 2;$$

$$I_3(t) = -\left(\frac{4}{5}\right)e^{-2t} + \left(\frac{4}{5}\right)e^{-8t}$$

### EXERCISES 9.7: Nonhomogeneous Linear Systems

2.  $c_1 \begin{bmatrix} e^{3t} \\ 2e^{3t} \end{bmatrix} + c_2 \begin{bmatrix} e^{-t} \\ -2e^{-t} \end{bmatrix} + \begin{bmatrix} t \\ 2 \end{bmatrix}$

4.  $c_1 \begin{bmatrix} 1 \\ -1 \end{bmatrix} + c_2 \begin{bmatrix} e^{4t} \\ e^{4t} \end{bmatrix} + \begin{bmatrix} -2 \sin t \\ 2 \sin t + \cos t \end{bmatrix}$

6.  $\mathbf{x}_p = t\mathbf{a} + \mathbf{b} + e^{3t}\mathbf{c}$

8.  $\mathbf{x}_p = t^2\mathbf{a} + t\mathbf{b} + \mathbf{c}$

10.  $\mathbf{x}_p = e^{-t}\mathbf{a} + te^{-t}\mathbf{b}$

12.  $c_1 e^{4t} \begin{bmatrix} 2 \\ 3 \end{bmatrix} + c_2 e^{-t} \begin{bmatrix} 1 \\ -1 \end{bmatrix} + \begin{bmatrix} 1 \\ -1 \end{bmatrix}$

14.  $c_1 \begin{bmatrix} \cos t \\ \sin t \end{bmatrix} + c_2 \begin{bmatrix} -\sin t \\ \cos t \end{bmatrix} + \begin{bmatrix} 2t - 1 \\ t^2 - 2 \end{bmatrix}$

16.  $c_1 \begin{bmatrix} \cos t \\ -\sin t \end{bmatrix} + c_2 \begin{bmatrix} \sin t \\ \cos t \end{bmatrix} + \begin{bmatrix} 4t \sin t \\ 4t \cos t - 4 \sin t \end{bmatrix}$

18.  $c_1 e^t \begin{bmatrix} 1 \\ 0 \\ 0 \end{bmatrix} + c_2 e^t \begin{bmatrix} 0 \\ 1 \\ 1 \end{bmatrix} + c_3 e^t \begin{bmatrix} t \\ t \\ t+1 \end{bmatrix} + \begin{bmatrix} -te^t - e^t \\ 0 \\ -e^t \end{bmatrix}$

20.  $\begin{bmatrix} -c_1 \sin 2t + c_2 \cos 2t - c_3 e^{-2t} + 8c_4 e^t + (8/15)te^t + (17/225)e^t - (1/8) \\ -2c_1 \cos 2t - 2c_2 \sin 2t + 2c_3 e^{-2t} + 8c_4 e^t + (8/15)te^t - (88/225)e^t \\ 4c_1 \sin 2t - 4c_2 \cos 2t - 4c_3 e^{-2t} + 8c_4 e^t + (8/15)te^t + (32/225)e^t \\ 8c_1 \cos 2t + 8c_2 \sin 2t + 8c_3 e^{-2t} + 8c_4 e^t + (8/15)te^t + (152/225)e^t - 1 \end{bmatrix}$

$$22. \text{ (a) } \begin{bmatrix} 3e^{-4t} + e^{2t} \\ -6e^{-4t} + e^{2t} - 2t \end{bmatrix}$$

$$\text{ (b) } \begin{bmatrix} -(4/3)e^{-4(t-2)} + (7/3)e^{2(t-2)} \\ (8/3)e^{-4(t-2)} + (7/3)e^{2(t-2)} - 2t \end{bmatrix}$$

$$24. x(t) = 3e^{-4t} + e^{2t};$$

$$y(t) = -6e^{-4t} + e^{2t} - 2t;$$

$$26. \text{ (a) } \begin{bmatrix} e^t \\ -2e^t \end{bmatrix} \quad \text{ (b) } \begin{bmatrix} te^t \\ te^t \end{bmatrix}$$

$$28. \begin{bmatrix} -t + 1 \\ -t - 1 \end{bmatrix}$$

$$30. c_1 t^{-2} \begin{bmatrix} 1 \\ 2 \end{bmatrix} + c_2 \begin{bmatrix} 3 \\ 4 \end{bmatrix} + t \begin{bmatrix} 1/3 \\ 2/3 \end{bmatrix}$$

34. (a) Neither wins.

(b) The  $x_1$  force wins.

(c) The  $x_2$  force wins.

### EXERCISES 9.8: The Matrix Exponential Function

$$2. \text{ (a) } r = 2; k = 2 \quad \text{ (b) } e^{2t} \begin{bmatrix} 1-t & -t \\ t & 1+t \end{bmatrix}$$

$$4. \text{ (a) } r = 2; k = 3$$

$$\text{ (b) } e^{2t} \begin{bmatrix} 1 & t & 3t - \frac{t^2}{2} \\ 0 & 1 & -t \\ 0 & 0 & 1 \end{bmatrix}$$

$$6. \text{ (a) } r = -1; k = 3$$

$$\text{ (b) } e^{-t} \begin{bmatrix} 1+t+\frac{t^2}{2} & t+t^2 & \frac{t^2}{2} \\ -\frac{t^2}{2} & 1+t-t^2 & t-\frac{t^2}{2} \\ -t+\frac{t^2}{2} & -3t+t^2 & 1-2t+\frac{t^2}{2} \end{bmatrix}$$

Chapter 9

$$8. \begin{bmatrix} (1/2)e^{3t} + (1/2)e^{-t} & (1/4)e^{3t} - (1/4)e^{-t} \\ e^{3t} - e^{-t} & (1/2)e^{3t} + (1/2)e^{-t} \end{bmatrix}$$

$$10. \frac{1}{3} \begin{bmatrix} e^{4t} + 2e^{-2t} & e^{4t} - e^{-2t} & e^{4t} - e^{-2t} \\ e^{4t} - e^{-2t} & e^{4t} + 2e^{-2t} & e^{4t} - e^{-2t} \\ e^{4t} - e^{-2t} & e^{4t} - e^{-2t} & e^{4t} + 2e^{-2t} \end{bmatrix}$$

$$12. \frac{1}{9} \begin{bmatrix} 3e^{-t} + 6e^{2t} & -3e^{-t} + 3e^{2t} & -3e^{-t} + 3e^{2t} \\ -4e^{-t} + 4e^{2t} + 6te^{2t} & 4e^{-t} + 5e^{2t} + 3te^{2t} & 4e^{-t} - 4e^{2t} + 3te^{2t} \\ -2e^{-t} + 2e^{2t} - 6te^{2t} & 2e^{-t} - 2e^{2t} - 3te^{2t} & 2e^{-t} + 7e^{2t} - 3te^{2t} \end{bmatrix}$$

$$14. \begin{bmatrix} e^t & 0 & 0 & 0 & 0 \\ 0 & e^t + te^{-t} & te^{-t} & 0 & 0 \\ 0 & -te^{-t} & e^{-t} - te^{-t} & 0 & 0 \\ 0 & 0 & 0 & \cos t & \sin t \\ 0 & 0 & 0 & -\sin t & \cos t \end{bmatrix}$$

$$16. \begin{bmatrix} e^{-t} & 0 & 0 & 0 & 0 \\ 0 & e^{-t} + te^{-t} & te^{-t} & 0 & 0 \\ 0 & -te^{-t} & e^{-t} - te^{-t} & 0 & 0 \\ 0 & 0 & 0 & e^{-2t} + 2te^{-2t} & te^{-t} \\ 0 & 0 & 0 & -4te^{-2t} & e^{-2t} - 2te^{-2t} \end{bmatrix}$$

$$18. c_1 \begin{bmatrix} 1 \\ 0 \\ 0 \end{bmatrix} + c_2 e^t \begin{bmatrix} 0 \\ 1 \\ 0 \end{bmatrix} + c_3 e^t \begin{bmatrix} 1 \\ 2t \\ 1 \end{bmatrix}$$

$$20. c_1 e^t \begin{bmatrix} -4 \\ 1 \\ 0 \end{bmatrix} + c_2 e^t \begin{bmatrix} 3 - 4t \\ t \\ 2 \end{bmatrix} + c_3 e^t \begin{bmatrix} 1 - 2t + 4t^2 \\ -t - t^2 \\ -4t \end{bmatrix}$$

$$22. \begin{bmatrix} -(4/3)e^{-t} + (1/3)e^{2t} \\ (16/9)e^{-t} - (16/9)e^{2t} + (1/3)te^{2t} \\ (8/9)e^{-t} + (19/9)e^{2t} - (1/3)te^{2t} \end{bmatrix}$$

$$24. \begin{bmatrix} e^t + \cos t - \sin t - 1 - t \\ e^t - \sin t - \cos t - 1 \\ e^t - \cos t + \sin t \end{bmatrix}$$

## REVIEW PROBLEMS

$$2. c_1 e^{2t} \begin{bmatrix} -2 \cos 3t \\ \cos 3t + 3 \sin 3t \end{bmatrix} + c_2 e^{2t} \begin{bmatrix} -2 \sin 3t \\ \sin 3t - 3 \cos 3t \end{bmatrix}$$

$$4. c_1 e^{2t} \begin{bmatrix} 0 \\ 0 \\ 1 \end{bmatrix} + c_2 e^t \begin{bmatrix} 1 \\ 0 \\ 0 \end{bmatrix} + c_3 \begin{bmatrix} t \\ 1 \\ 0 \end{bmatrix}$$

$$6. \begin{bmatrix} 0 & e^{5t} & 0 \\ 3e^{-5t} & 0 & e^{5t} \\ -e^{-5t} & 0 & 3e^{5t} \end{bmatrix}$$

$$8. c_1 \begin{bmatrix} 1 \\ 2 \end{bmatrix} + c_2 \begin{bmatrix} 2e^{-5t} \\ -e^{-5t} \end{bmatrix} + e^{4t} \begin{bmatrix} 11/36 \\ 13/18 \end{bmatrix}$$

$$10. c_1 e^{2t} \begin{bmatrix} 1 \\ 0 \\ 0 \end{bmatrix} + c_2 \left\{ e^{5t/2} \cos \left( \frac{\sqrt{7}t}{2} \right) \begin{bmatrix} 11 \\ -2 \\ 4 \end{bmatrix} - e^{5t/2} \sin \left( \frac{\sqrt{7}t}{2} \right) \begin{bmatrix} -3\sqrt{7} \\ -2\sqrt{7} \\ 0 \end{bmatrix} \right\} \\ + c_3 \left\{ e^{5t/2} \sin \left( \frac{\sqrt{7}t}{2} \right) \begin{bmatrix} 11 \\ -2 \\ 4 \end{bmatrix} + e^{5t/2} \cos \left( \frac{\sqrt{7}t}{2} \right) \begin{bmatrix} -3\sqrt{7} \\ -2\sqrt{7} \\ 0 \end{bmatrix} \right\} + \begin{bmatrix} -(1/3)e^{-t} + 11/16 \\ -1/4 \\ -5/8 \end{bmatrix}$$

$$12. \begin{bmatrix} e^{2t} \sin 2t + (3/2)e^{2t} \cos 2t + (1/2)e^{2t} \\ 2e^{2t} \cos 2t - 3e^{2t} \sin 2t - te^{2t} \end{bmatrix}$$

$$14. c_1 t \begin{bmatrix} -1 \\ 1 \\ 2 \end{bmatrix} + c_2 t^3 \begin{bmatrix} 1 \\ 1 \\ 0 \end{bmatrix} + c_3 t^{-2} \begin{bmatrix} 1 \\ -1 \\ 1 \end{bmatrix}$$

$$16. \begin{bmatrix} 1 & t & 4t + t^2 \\ 0 & 1 & 2t \\ 0 & 0 & 1 \end{bmatrix}$$

FIGURES

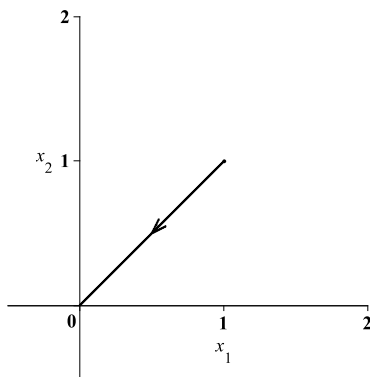


Figure 9-A: Problem 18(b), Section 9.5

---

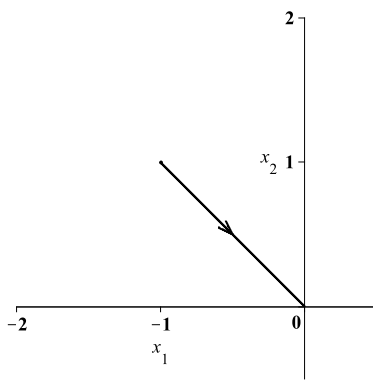


Figure 9-B: Problem 18(c), Section 9.5

---

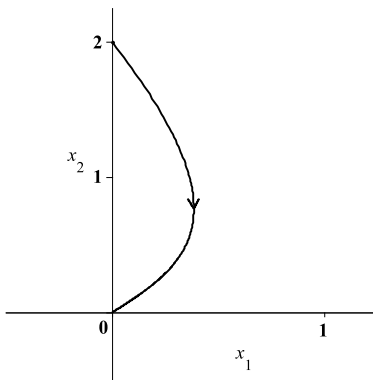


Figure 9-C: Problem 18(d), Section 9.5

---

## CHAPTER 10: Partial Differential Equations

### EXERCISES 10.2: Method of Separation of Variables

2.  $y = \frac{(e^{10} - 1)e^x + (1 - e^2)e^{5x}}{e^{10} - e^2}$

4.  $y = 2 \sin 3x$

6. No solution

8.  $y = e^{x-1} + xe^{x-1}$

10.  $\lambda_n = \frac{(2n-1)^2}{4}$  and  $y_n = c_n \cos\left(\frac{2n-1}{2}x\right)$ , where  $n = 1, 2, 3, \dots$  and  $c_n$ 's are arbitrary

12.  $\lambda_n = 4n^2$  and  $y_n = c_n \cos(2nx)$ , where  $n = 0, 1, 2, \dots$  and  $c_n$ 's are arbitrary

14.  $\lambda_n = n^2 + 1$  and  $y_n = c_n e^x \sin(nx)$ , where  $n = 1, 2, 3, \dots$  and  $c_n$ 's are arbitrary

16.  $u(x, t) = e^{-27t} \sin 3x + 5e^{-147t} \sin 7x - 2e^{-507t} \sin 13x$

18.  $u(x, t) = e^{-48t} \sin 4x + 3e^{-108t} \sin 6x - e^{-300t} \sin 10x$

20.  $u(x, t) = -\left(\frac{2}{9}\right) \sin 9t \sin 3x + \left(\frac{3}{7}\right) \sin 21t \sin 7x - \left(\frac{1}{30}\right) \sin 30t \sin 10x$

22.  $u(x, t) = \cos 3t \sin x - \cos 6t \sin 2x + \cos 9t \sin 3x + \left(\frac{2}{3}\right) \sin 9t \sin 3x - \left(\frac{7}{15}\right) \sin 15t \sin 5x$

24.  $u(x, t) = \sum_{n=1}^{\infty} \left[ \frac{1}{n^2} \cos 4nt + \frac{(-1)^{n+1}}{4n^2} \sin 4nt \right] \sin nx$

### EXERCISES 10.3: Fourier Series

2. Even

4. Neither

6. Odd



## Chapter 10

$$10. f(x) \sim \frac{\pi}{2} - \frac{4}{\pi} \sum_{k=0}^{\infty} \frac{1}{(2k+1)^2} \cos(2k+1)x$$

$$12. f(x) \sim \frac{\pi^2}{6} + \sum_{n=1}^{\infty} \left[ \frac{2(-1)^n}{n^2} \cos nx + \frac{(-1)^n (2 - n^2\pi^2) - 2}{\pi n^3} \sin nx \right]$$

$$14. f(x) \sim \frac{\pi}{2} + \sum_{n=1}^{\infty} \frac{1}{n} \sin 2nx$$

$$16. f(x) \sim \sum_{n=1}^{\infty} \frac{2[1 - \cos(\pi n/2)]}{\pi n} \sin nx$$

18. The  $2\pi$ -periodic function  $g(x)$ , where  $g(x) = |x|$  on  $-\pi \leq x \leq \pi$

$$20. \text{ The } 2\pi\text{-periodic function } g(x), \text{ where } g(x) = \begin{cases} 0, & -\pi < x \leq 0 \\ x^2, & 0 < x < \pi \\ \pi^2/2, & x = \pm\pi \end{cases}$$

$$22. \text{ The } 2\pi\text{-periodic function } g(x), \text{ where } g(x) = \begin{cases} x + \pi, & -\pi < x < 0 \\ x, & 0 < x < \pi \\ \pi/2, & x = 0, \pm\pi \end{cases}$$

$$24. \text{ The } 2\pi\text{-periodic function } g(x), \text{ where } g(x) = \begin{cases} 0, & -\pi \leq x < -\pi/2 \\ -1/2, & x = -\pi/2 \\ -1, & -\pi/2 < x < 0 \\ 0, & x = 0 \\ 1, & 0 < x < \pi/2 \\ 1/2, & x = \pi/2 \\ 0, & \pi/2 < x \leq \pi \end{cases}$$

$$30. a_0 = \frac{1}{2}, a_1 = 0, a_2 = \frac{5}{8}$$

### EXERCISES 10.4: Fourier Cosine and Sine Series

2. (a) The  $\pi$ -periodic function  $\tilde{f}(x) = \sin 2x$  for  $x \neq k\pi$ , where  $k$  is an integer  
 (b) The  $2\pi$ -periodic function  $f_o(x) = \sin 2x$  for  $x \neq k\pi$ , where  $k$  is an integer  
 (c) The  $2\pi$ -periodic function  $f_e(x)$ , where  $f_e(x) = \begin{cases} -\sin 2x, & -\pi < x < 0 \\ \sin 2x, & 0 < x < \pi \end{cases}$

4. (a) The  $\pi$ -periodic function  $\tilde{f}(x)$ , where  $\tilde{f}(x) = \pi - x$ ,  $0 < x < \pi$
- (b) The  $2\pi$ -periodic function  $f_o(x)$ , where  $f_o(x) = \begin{cases} -\pi - x, & -\pi < x < 0 \\ \pi - x, & 0 < x < \pi \end{cases}$
- (c) The  $2\pi$ -periodic function  $f_e(x)$ , where  $f_e(x) = \begin{cases} \pi + x, & -\pi < x < 0 \\ \pi - x, & 0 < x < \pi \end{cases}$

$$6. f(x) \sim \frac{8}{\pi} \sum_{k=1}^{\infty} \frac{k}{4k^2 - 1} \sin(2kx)$$

$$8. f(x) \sim 2 \sum_{n=1}^{\infty} \frac{1}{n} \sin(nx)$$

$$10. f(x) \sim 2\pi \sum_{n=1}^{\infty} \frac{n[1 - e(-1)^n]}{1 + \pi^2 n^2} \sin(\pi n x)$$

$$12. f(x) \sim 1 + \frac{\pi}{2} - \frac{4}{\pi} \sum_{k=0}^{\infty} \frac{1}{(2k+1)^2} \cos[(2k+1)x]$$

$$14. f(x) \sim 1 - \frac{1}{e} + 2 \sum_{n=1}^{\infty} \frac{1 - (-1)^n e^{-1}}{1 + \pi^2 n^2} \cos(\pi n x)$$

$$16. f(x) \sim \frac{1}{6} - \frac{1}{\pi^2} \sum_{k=1}^{\infty} \frac{1}{k^2} \cos(2\pi k x)$$

$$18. u(x, t) = \frac{8}{\pi} \sum_{k=0}^{\infty} \frac{1}{(2k+1)^3} e^{-5(2k+1)^2 t} \sin[(2k+1)x]$$

### EXERCISES 10.5: The Heat Equation

$$2. u(x, t) = \sum_{n=1}^{\infty} \left[ \frac{2\pi(-1)^{n+1}}{n} + \frac{4[(-1)^n - 1]}{\pi n^3} \right] e^{-n^2 t} \sin(nx)$$

$$4. u(x, t) = \frac{1}{6} - \frac{1}{\pi^2} \sum_{k=1}^{\infty} \frac{1}{k^2} e^{-8\pi^2 k^2 t} \cos(2\pi k x)$$

$$6. u(x, t) = 1 - \frac{2}{\pi} + 2e^{-7t} \cos x + \frac{4}{\pi} \sum_{k=1}^{\infty} \frac{1}{4k^2 - 1} e^{-28k^2 t} \cos(2kx)$$

$$8. u(x, t) = 3x + 6 \sum_{n=1}^{\infty} \frac{(-1)^n}{n} e^{-n^2 t} \sin(nx)$$

## Chapter 10

$$10. u(x, t) = \left(\frac{\pi^2}{18}\right)x - \left(\frac{1}{18}\right)x^3 + \left(\frac{1}{3}\right)e^{-3t}\sin x + \frac{2}{3}\sum_{n=2}^{\infty}\frac{(-1)^n}{n^3}e^{-3n^2t}\sin(nx)$$

$$12. u(x, t) = \sum_{n=1}^{\infty} a_n e^{-\mu_n^2 t} \sin(\mu_n x), \text{ where } \{\mu_n\}_{n=1}^{\infty} \text{ is the increasing sequence of positive real numbers that are solutions to } \tan(\mu_n \pi) = -\mu_n, \text{ and}$$

$$a_n = \left[ \frac{\pi}{2} - \frac{\sin(2\pi\mu_n)}{4} \right]^{-1} \int_0^{\pi} f(x) \sin(\mu_n x) dx$$

$$14. u(x, t) = 1 + \left(\frac{5\pi}{6}\right)x - \left(\frac{5}{6}\right)x^2 - \frac{20}{3\pi} \sum_{k=0}^{\infty} \frac{1}{(2k+1)^3} e^{-3(2k+1)^2 t} \sin[(2k+1)x]$$

$$16. u(x, y, t) = e^{-2t} \cos x \sin y + 4e^{-5t} \cos 2x \sin y - 3e^{-25t} \cos 3x \sin 4y$$

$$18. u(x, y, t) = \left(\frac{\pi}{2}\right)e^{-t} \sin y - \frac{4}{\pi} \sum_{k=0}^{\infty} \frac{1}{(2k+1)^2} e^{-[(2k+1)^2+1]t} \cos[(2k+1)x] \sin y$$

### EXERCISES 10.6: The Wave Equation

$$2. u(x, t) = \sum_{n=1}^{\infty} (a_n \cos 4nt + b_n \sin 4nt) \sin nx, \text{ where}$$

$$a_n = \begin{cases} 0, & n \text{ even} \\ (2/\pi) [n/(n^2 - 4) - 1/n], & n \text{ odd} \end{cases}$$

and

$$b_n = \begin{cases} -1/[4\pi(n^2 - 1)], & n \text{ even} \\ 1/(\pi n^2), & n \text{ odd} \end{cases}$$

$$4. u(x, t) = \sin 4x \cos 12t + 7 \sin 5x \cos 15t + \frac{4}{3\pi} \sum_{k=0}^{\infty} \frac{(-1)^k}{(2k+1)^3} \sin[(2k+1)x] \sin[3(2k+1)t]$$

$$6. u(x, t) = \frac{2\nu_0 L^3}{\pi^3 \alpha a(L-a)} \sum_{n=1}^{\infty} \frac{1}{n^3} \sin\left(\frac{n\pi a}{L}\right) \sin\left(\frac{n\pi x}{L}\right) \sin\left(\frac{n\pi \alpha t}{L}\right)$$

$$8. u(x, t) = \sin x (\sin t - t \cos t) + 2 \sum_{n=2}^{\infty} \frac{(-1)^n}{n^2(n^2 - 1)} (\sin nt - n \sin t) \sin nx$$

$$10. u(x, t) = U_1 + \left(\frac{x}{L}\right)(U_2 - U_1) + \sum_{n=1}^{\infty} \left[ a_n \cos\left(\frac{\pi \alpha n t}{L}\right) + b_n \sin\left(\frac{\pi \alpha n t}{L}\right) \right] \sin\left(\frac{\pi n x}{L}\right),$$

where  $a_n$ 's and  $b_n$ 's are chosen that

$$f(x) = \sum_{n=1}^{\infty} a_n \sin\left(\frac{\pi n x}{L}\right) + U_1 + \left(\frac{x}{L}\right)(U_2 - U_1)$$

$$g(x) = \sum_{n=1}^{\infty} b_n \left(\frac{\pi \alpha n}{L}\right) \sin\left(\frac{\pi n x}{L}\right)$$

14.  $u(x, t) = x^2 + \alpha^2 t^2$

16.  $u(x, t) = \sin 3x \cos 3\alpha t + t$

18.  $u(x, t) = \cos 2x \cos 2\alpha t + t - xt$

### EXERCISES 10.7: Laplace's Equation

2.  $u(x, y) = \frac{\cos x \sinh(y - \pi)}{\sinh(-\pi)} - \frac{2 \cos 4x \sinh(4y - 4\pi)}{\sinh(-4\pi)}$

4.  $u(x, y) = \frac{\sin x \sinh(y - \pi)}{\sinh(-\pi)} + \frac{\sin 4x \sinh(4y - 4\pi)}{\sinh(-4\pi)}$

8.  $u(r, \theta) = \frac{1}{2} + \frac{r^2}{8} \cos 2\theta$

12.  $u(r, \theta) = \frac{3^3}{3^6 - 1} (r^3 - r^{-3}) \cos 3\theta + \frac{3^5}{3^{10} - 1} (r^5 - r^{-5}) \cos 5\theta$

14.  $u(r, \theta) = C + \sum_{n=1}^{\infty} r^{-n} (a_n \cos n\theta + b_n \sin n\theta),$

where  $C$  is arbitrary and, for  $n = 1, 2, \dots,$

$$a_n = -\frac{1}{\pi n} \int_{-\pi}^{\pi} f(\theta) \cos n\theta \, d\theta,$$

$$b_n = -\frac{1}{\pi n} \int_{-\pi}^{\pi} f(\theta) \sin n\theta \, d\theta$$

16.  $u(r, \theta) = \sum_{n=1}^{\infty} a_n \sinh\left[\frac{\pi(\theta - \pi)n}{\ln 2}\right] \sin\left[\frac{\pi(\ln r - \ln \pi)n}{\ln 2}\right],$  where

$$a_n = -\frac{2}{(\ln 2) \sinh(n\pi^2/\ln 2)} \int_{\pi}^{2\pi} (\sin r) \sin\left[\frac{\pi(\ln r - \ln \pi)n}{\ln 2}\right] \frac{dr}{r}$$

## Chapter 10

$$24. u(x, y) = \sum_{n=1}^{\infty} A_n e^{-ny} \sin nx,$$

$$\text{where } A_n = \frac{2}{\pi} \int_0^{\pi} f(x) \sin nx \, dx$$

## CHAPTER 11: Eigenvalue Problems and Sturm-Liouville Equations

### EXERCISES 11.2: Eigenvalues and Eigenfunctions

2.  $\sin x - \cos x + x + 1$
4.  $ce^{-2x}(\sin 2x + \cos 2x)$
6.  $2e^x + e^{-x} - x$
8.  $c_1 \sin 2x + c_2 \cos 2x + 1$
10. No solution
12. No solution
14.  $\lambda_n = \frac{\pi^2 n^2}{9}$ ;  $y_n(x) = b_n \sin\left(\frac{\pi n x}{3}\right) + c_n \cos\left(\frac{\pi n x}{3}\right)$ ,  $n = 0, 1, 2, \dots$
16.  $\lambda_n = 2 + \frac{(2n+1)^2}{4}$ ;  $y_n(x) = c_n \sin\left[\frac{(2n+1)x}{2}\right]$ ,  $n = 0, 1, 2, \dots$
18.  $\lambda_0 = -\mu_0^2$ , where  $\tanh(\mu_0\pi) = 2\mu_0$ ;  $y_0(x) = c_0 \sinh(\mu_0 x)$ ;  
 $\lambda_n = \mu_n^2$ , where  $\tan(\mu_n\pi) = 2\mu_n$ ;  $y_n(x) = c_n \sin(\mu_n x)$ ,  $n = 1, 2, 3, \dots$
20.  $\lambda_n = \pi^2 n^2$ ,  $y_n(x) = c_n \cos(\pi n \ln x)$ ,  $n = 0, 1, 2, \dots$
22.  $\lambda_1 = 4.116$ ,  $\lambda_2 = 24.139$ ,  $\lambda_3 = 63.659$
24. No nontrivial solutions
26.  $\lambda_n = \mu_n^2$ , where  $\cot(\mu_n\pi) = \mu_n$  for  $\mu_n > 0$ ;  $y_n(x) = c_n \sin(\mu_n x)$ ,  $n = 1, 2, 3, \dots$
28.  $\lambda_n = -\mu_n^4$ ,  $\mu_n > 0$  and  $\cos(\mu_n L) \cosh(\mu_n L) = -1$ ;  
 $y_n = c_n \left[ \sin(\mu_n x) - \sinh(\mu_n x) - \left( \frac{\sin(\mu_n L) + \sinh(\mu_n L)}{\cos(\mu_n L) + \cosh(\mu_n L)} \right) (\cos(\mu_n x) - \cosh(\mu_n x)) \right]$ ,  
 $n = 1, 2, 3, \dots$

## Chapter 11

34. (b)  $\lambda_0 = -1, X_0(x) = c$  and  $\lambda_n = -1 + n^2\pi^2, X_n(x) = c \cos(\pi nx)$

### EXERCISES 11.3: Regular Sturm-Liouville Boundary Value Problems

2.  $y'' + \lambda x^{-1}y = 0$

4.  $(xy')' + xy - \lambda x^{-1}y = 0$

6.  $[(1-x^2)y']' + \lambda y = 0$

8. Yes

10. No

18. (a)  $\frac{1}{\sqrt{6}}, \left(\frac{1}{\sqrt{3}}\right) \sin\left(\frac{n\pi x}{3}\right), \left(\frac{1}{\sqrt{3}}\right) \cos\left(\frac{n\pi x}{3}\right), n = 1, 2, 3, \dots$

(b)  $\sum_{n=1}^{\infty} \frac{(-1)^{n+1} 6}{\pi n} \sin\left(\frac{n\pi x}{3}\right)$

20. (a)  $\sqrt{\frac{2}{\pi}} \sin\left[\left(n + \frac{1}{2}\right)x\right], n = 0, 1, 2, \dots$

(b)  $\sum_{n=0}^{\infty} \frac{(-1)^n 8}{\pi (2n+1)^2} \sin\left[\left(n + \frac{1}{2}\right)x\right]$

22. (a)  $2\sqrt{\frac{\mu_0}{\sinh(2\mu_0\pi) - 2\mu_0\pi}} \sinh(\mu_0 x),$  where  $\tanh(\mu_0\pi) = 2\mu_0;$

$2\sqrt{\frac{\mu_n}{2\mu_n\pi - \sin(2\mu_n\pi)}} \sin(\mu_n x),$  where  $\tan(\mu_n\pi) = 2\mu_n, n = 1, 2, 3, \dots$

(b)  $\frac{4(\pi - 2) \cosh(\mu_0\pi)}{\sinh(2\mu_0\pi) - 2\mu_0\pi} \sinh(\mu_0\pi) + \sum_{n=1}^{\infty} \frac{4(2 - \pi) \cos(\mu_n\pi)}{2\mu_n\pi - \sin(2\mu_n\pi)} \sin(\mu_n x)$

24. (a)  $y_0(x) = \frac{1}{\sqrt{e-1}}; y_n(x) = \sqrt{2} \cos(\pi n \ln x), n = 1, 2, 3, \dots$

(b)  $1 + \sum_{n=1}^{\infty} \frac{2[(-1)^n e - 1]}{1 + \pi^2 n^2} \cos(\pi n \ln x)$

### EXERCISES 11.4: Nonhomogeneous Boundary Value Problems and the Fredholm Alternative

2.  $L^+[y] = x^2 y'' + (4x - \sin x) y' + (2x + 2 - \cos x) y$

$$4. L^+[y] = x^2 y'' + 6xy' + 7y$$

$$6. L^+[y] = (\sin x) y'' + (2 \cos x + e^x) y' + (-\sin x + e^x + 1)y$$

$$8. L^+[y] = y'' + 4y' + 5y;$$

$$D(L^+) = \{y \in C^2[0, 2\pi] : y(0) = y(2\pi) = 0\}$$

$$10. L^+[y] = x^2 y'' + 2xy' + \left(\frac{5}{4}\right) y;$$

$$D(L^+) = \{y \in C^2[1, e^\pi] : y(1) = y(e^\pi) = 0\}$$

$$12. y'' - y' + y = 0; y(0) = y(\pi), y'(0) = y'(\pi)$$

$$14. y'' = 0; y(0) = y\left(\frac{\pi}{2}\right), y'(0) = y'\left(\frac{\pi}{2}\right)$$

$$16. x^2 y'' + 2xy' = 0; y(1) = 4y(2), y'(1) = 4y'(2)$$

$$18. \int_0^{2\pi} h(x) e^{-2x} \sin x \, dx = 0$$

$$20. \int_1^{e^\pi} h(x) x^{-1/2} \sin(\ln x) \, dx = 0$$

22. Unique solution for each  $h$

$$24. \int_0^{\pi/2} h(x) \, dx = 0$$

$$26. \int_1^2 h(x) \left(1 - \frac{3}{x}\right) \, dx = 0$$

### EXERCISES 11.5: Solution by Eigenfunction Expansion

$$2. \left(\frac{1}{122}\right) \sin 11x - \left(\frac{1}{17}\right) \sin 4x$$

$$4. \left(\frac{1}{\pi - 49}\right) \cos 7x + \left(\frac{5}{\pi - 100}\right) \cos 10x$$

$$6. \left(\frac{1}{19}\right) \cos 5x - \left(\frac{1}{10}\right) \cos 4x$$



## Chapter 11

$$8. \sum_{n=0}^{\infty} \frac{-8}{\pi(2n+1)^3(4n^2+4n-1)} \sin[(2n+1)x]$$

$$10. \sum_{n=0}^{\infty} \frac{\gamma_n}{7 - \left(n + \frac{1}{2}\right)^2} \sin \left[ \left(n + \frac{1}{2}\right) x \right], \text{ where } \gamma_n = \frac{2}{\pi} \int_0^{\pi} f(x) \sin \left[ \left(n + \frac{1}{2}\right) x \right] dx$$

$$12. \text{ Let } \gamma_n = \frac{2}{\pi} \int_1^{e^{\pi}} f(x) \sin(n \ln x) dx.$$

If  $\gamma_1 \neq 0$ , there is no solution.

If  $\gamma_1 = 0$ , then

$$c \sin(\ln x) + \sum_{n=2}^{\infty} \frac{\gamma_n}{1 - n^2} \sin(n \ln x) \text{ is a solution}$$

$$14. \sum_{n=0}^{\infty} \frac{\gamma_n}{-1 - \pi^2 n^2} \cos(\pi n \ln x), \text{ where } \gamma_n = \frac{\int_1^e f(x) \cos(\pi n \ln x) dx}{\int_1^e x^{-1} \cos^2(\pi n \ln x) dx}$$

### EXERCISES 11.6: Green's Functions

$$2. G(x, s) = \begin{cases} -\frac{\sinh s \sinh(x-1)}{\sinh 1}, & 0 \leq s \leq x \\ -\frac{\sinh x \sinh(s-1)}{\sinh 1}, & x \leq s \leq 1 \end{cases}$$

$$4. G(x, s) = \begin{cases} -\cos s \sin x, & 0 \leq s \leq x \\ -\cos x \sin s, & x \leq s \leq \pi \end{cases}$$

$$6. G(x, s) = \begin{cases} (\sin s - \cos s) \sin x, & 0 \leq s \leq x \\ (\sin x - \cos x) \sin s, & x \leq s \leq \pi \end{cases}$$

$$8. G(x, s) = \begin{cases} -\frac{(s^2 + s^{-2})(x^2 - 16x^{-2})}{68}, & 0 \leq s \leq x \\ -\frac{(x^2 + x^{-2})(s^2 - 16s^{-2})}{68}, & x \leq s \leq 2 \end{cases}$$

$$10. G(x, s) = \begin{cases} \frac{(e^{5s} - e^{-s})(5e^{6-x} + e^{5x})}{30e^6 + 6}, & 0 \leq s \leq x \\ \frac{(e^{5x} - e^{-x})(5e^{6-s} + e^{5s})}{30e^6 + 6}, & x \leq s \leq 1 \end{cases}$$

$$12. G(x, s) = \begin{cases} -\frac{s(x - \pi)}{\pi}, & 0 \leq s \leq x \\ -\frac{x(s - \pi)}{\pi}, & x \leq s \leq \pi \end{cases}$$

$$y = \frac{x^4 - \pi^3 x}{12}$$

$$14. G(x, s) = \begin{cases} s, & 0 \leq s \leq x \\ x, & x \leq s \leq \pi \end{cases}$$

$$y = \frac{4\pi^3 x - x^4}{12}$$

$$16. G(x, s) = \begin{cases} -\frac{\sin s \sin(x - 2)}{\sin 2}, & 0 \leq s \leq x \\ -\frac{\sin x \sin(s - 2)}{\sin 2}, & x \leq s \leq 2 \end{cases}$$

$$y = \frac{12}{\sin 2} [\sin x - \sin(x - 2) - \sin 2]$$

$$18. G(x, s) = \begin{cases} \frac{\cosh s \cosh(x - 1)}{\sinh 1}, & 0 \leq s \leq x \\ \frac{\cosh x \cosh(s - 1)}{\sinh 1}, & x \leq s \leq 1 \end{cases}$$

$$y = -24$$

$$20. G(x, s) = \begin{cases} -\left(1 - \frac{1}{s}\right) \left(1 - \frac{2}{x}\right), & 1 \leq s \leq x \\ -\left(1 - \frac{1}{x}\right) \left(1 - \frac{2}{s}\right), & x \leq s \leq 2 \end{cases}$$

$$y = \frac{2 \ln 2}{x} + \ln \left(\frac{x}{4}\right)$$

$$24. \text{(a)} K(x, s) = \begin{cases} e^{x-s} s(1-x), & 0 \leq s \leq x \\ e^{x-s} x(1-s), & x \leq s \leq 1 \end{cases}$$

$$\text{(b)} y = (x-1)e^x - xe^{x-1} + 1$$

$$26. \text{ (a) } K(x, s) = \begin{cases} \frac{(s^2 - s^{-2})(3x + 16x^{-3})}{76}, & 1 \leq s \leq x \\ \frac{(x - x^{-3})(3s^2 + 16s^{-2})}{76}, & x \leq s \leq 2 \end{cases}$$

$$\text{(b) } y = \left(\frac{1}{4}\right)x \ln x + \frac{4(1 + \ln 2)}{19}(x^{-3} - x)$$

$$28. H(x, s) = \begin{cases} \frac{x(\pi - s)(s^2 - 2\pi s + x^2)}{6\pi}, & 0 \leq s \leq x \\ \frac{s(\pi - x)(x^2 - 2\pi x + s^2)}{6\pi}, & x \leq s \leq \pi \end{cases}$$

$$30. H(x, s) = \begin{cases} \frac{x^2[(x - 3\pi)(s^3 - 3\pi s^2) + 2\pi^3(x - 3s)]}{12\pi^3}, & 0 \leq s \leq x \\ \frac{s^2[(s - 3\pi)(x^3 - 3\pi x^2) + 2\pi^3(s - 3x)]}{12\pi^3}, & x \leq s \leq \pi \end{cases}$$

### EXERCISES 11.7: Singular Sturm-Liouville Boundary Value Problems

2.  $\sum_{n=1}^{\infty} b_n J_3(\alpha_{3n}x)$ , where  $\{\alpha_{3n}\}$  is the increasing sequence of real zeros of  $J_3$  and

$$b_n = \frac{\int_0^1 f(x) J_3(\alpha_{3n}x) dx}{(\mu - \alpha_{3n}^2) \int_0^1 J_3^2(\alpha_{3n}x) x dx}$$

4.  $\sum_{n=0}^{\infty} b_n P_n(x)$ , where

$$b_n = \frac{\int_{-1}^1 f(x) P_n(x) dx}{[\mu - n(n+1)] \int_{-1}^1 P_n^2(x) dx}$$

6.  $\sum_{n=0}^{\infty} b_n P_{2n}(x)$ , where

$$b_n = \frac{\int_0^1 f(x) P_{2n}(x) dx}{[\mu - 2n(2n+1)] \int_0^1 P_{2n}^2(x) dx}$$

16. (c)  $\sum_{n=0}^{\infty} b_n L_n(x)$ , where

$$b_n = \frac{\int_0^{\infty} f(x) L_n(x) dx}{(\mu - n) \int_0^{\infty} L_n^2(x) e^{-x} dx}$$

**EXERCISES 11.8: Oscillation and Comparison Theory**

2. No;  $\sin x$  has a finite number of zeros on any closed bounded interval.

4. No; it has an infinite number of zeros on the interval  $\left[-\frac{1}{2}, \frac{1}{2}\right]$

8.  $\frac{\pi}{3}$

10. Between  $\pi\sqrt{\frac{e^{-25}}{\lambda+1}}$  and  $\pi\sqrt{\frac{26}{\lambda+26\sin 5}}$

**REVIEW PROBLEMS**

2. (a)  $(e^{7x}y')' + \lambda e^{7x}y = 0$

(b)  $(e^{-3x^2/2}y')' + \lambda e^{-3x^2/2}y = 0$

(c)  $(xe^{-x}y')' + \lambda e^{-x}y = 0$

4. (a)  $y'' - xy' = 0$ ;  $y'(0) = 0$ ,  $y'(1) = 0$

(b)  $x^2y'' + 2xy' - 3y = 0$ ;  $y(1) = 0$ ,  $y'(e) = 0$

6.  $\frac{\pi}{6} + 4\cos 2x + \frac{2}{\pi} \sum_{k=0}^{\infty} \frac{1}{(2k^2 + 2k - 1)(2k + 1)^2} \cos[(2k + 1)x]$

8. (a)  $\sum_{n=1}^{\infty} b_n J_7(\alpha_{7n}x)$ , where  $\{\alpha_{7n}\}$  is the increasing sequence of real zeros of  $J_7$  and

$$b_n = \frac{\int_0^1 f(x) J_7(\alpha_{7n}x) dx}{(\mu - \alpha_{7n}^2) \int_0^1 J_7^2(\alpha_{7n}x) x dx}$$

(b)  $\sum_{n=0}^{\infty} b_n P_n(x)$ , where

## Chapter 11

$$b_n = \frac{\int_{-1}^1 f(x) P_n(x) dx}{[\mu - n(n+1)] \int_{-1}^1 P_n^2(x) dx}$$

10. Between  $\frac{\pi}{\sqrt{6}}$  and  $\pi\sqrt{\frac{3}{5}}$

## CHAPTER 12: Stability of Autonomous Systems

### EXERCISES 12.2: Linear Systems in the Plane

2. Unstable proper node
4. Unstable improper node
6. Stable center
8.  $(-1, -1)$  is an asymptotically stable spiral point
10.  $(2, -2)$  is an unstable spiral point
12.  $(5, 1)$  is an asymptotically stable improper node
14. Unstable proper node. See Fig. 12–A on page 309.
16. Asymptotically stable spiral point. See Fig. 12–B on page 309.
18. Unstable improper node. See Fig. 12–C on page 309.
20. Stable center. See Fig. 12–D on page 310.

### EXERCISES 12.3: Almost Linear Systems

2. Asymptotically stable improper node
4. Asymptotically stable spiral point
6. Unstable saddle point
8. Asymptotically stable improper node
10.  $(0, 0)$  is indeterminate;  $(-1, 1)$  is an unstable saddle point
12.  $(2, 2)$  is an asymptotically stable spiral point;  $(-2, -2)$  is an unstable saddle point

## Chapter 12

14.  $(3, 3)$  is an unstable saddle point;  $(-2, -2)$  is an asymptotically stable spiral point. See Fig. 12–E on page 310.
16.  $(0, 0)$  is an unstable saddle point;  $(-4, -2)$  is an asymptotically stable spiral point. See Fig. 12–F on page 310.

### EXERCISES 12.4: Energy Methods

2.  $G(x) = \sin x + C$ ;  $E(x, v) = \left(\frac{1}{2}\right)v^2 + \sin x$
4.  $G(x) = \left(\frac{1}{2}\right)x^2 - \left(\frac{1}{24}\right)x^4 + \left(\frac{1}{720}\right)x^6 + C$ ;  
 $E(x, v) = \left(\frac{1}{2}\right)v^2 + \left(\frac{1}{2}\right)x^2 - \left(\frac{1}{24}\right)x^4 + \left(\frac{1}{720}\right)x^6$
6.  $G(x) = e^x - x + C$ ;  $E(x, v) = \left(\frac{1}{2}\right)v^2 + e^x - x - 1$
8. See Fig. 12–G on page 311.
10. See Fig. 12–H on page 311.
12. See Fig. 12–I on page 312.
14.  $vh(x, v) = v^2$ , so energy decreasing along a trajectory. See Fig. 12–A on page 312.
16.  $vh(x, v) = v^2$ , so energy decreasing along a trajectory. See Fig. 12–B on page 313.
18. See Fig. 12–C on page 313.

### EXERCISES 12.5: Lyapunov's Direct Method

2. Asymptotically stable
4. Stable
6. Unstable
8. Asymptotically stable
10. Stable

12. Stable

14. Stable

### EXERCISES 12.6: Limit Cycles and Periodic Solutions

4. (b) Clockwise

6.  $r = 0$  is an unstable spiral point;  $r = 2$  is a stable limit cycle;  $r = 5$  is an unstable limit cycle. See Fig. 12–M on page 314.

8.  $r = 0$  is an unstable spiral point. See Fig. 12–N on page 314.

10.  $r = 0$  is an unstable spiral point;  $r = 2$  is a stable limit cycle;  $r = 3$  is a unstable limit cycle. See Fig. 12–O on page 314.

12.  $r = 0$  is an unstable spiral point;  $r = n\pi$  is limit cycle that is stable for  $n$  odd and unstable for  $n$  even. See Fig. 12–P on page 315.

### EXERCISES 12.7: Stability of Higher-Dimensional Systems

2. Asymptotically stable

4. Unstable

6. Asymptotically stable

8. (a)  $\mathbf{x}(t) = \begin{bmatrix} c_1 \\ c_2 \end{bmatrix}$

(b)  $\mathbf{x}(t) = c_1 \begin{bmatrix} 1 \\ 0 \end{bmatrix} + c_2 \begin{bmatrix} t \\ 1 \end{bmatrix}$

10. Stable

12. Asymptotically stable

14. Asymptotically stable

16. The equilibrium solution corresponding to the critical point  $(-3, 0, 1)$  is unstable

18. The equilibrium solutions corresponding to the critical points  $(0, 0, 0)$  and  $(0, 0, 1)$  are unstable

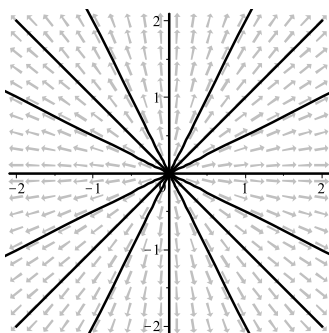


## Chapter 12

### REVIEW PROBLEMS

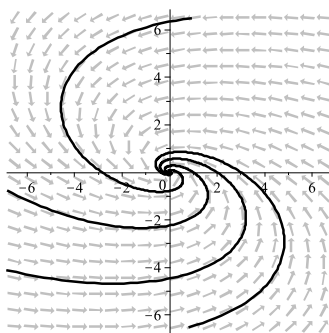
2.  $(0, 0)$  is an unstable saddle point. See Fig. **12–Q** on page 315.
4.  $(0, 0)$  is a stable center. See Fig. **12–R** on page 315.
6.  $(0, 0)$  is an unstable improper node. See Fig. **12–S** on page 316.
8. See Fig. **12–T** on page 316.
10. Unstable
12. Asymptotically stable
14.  $r = 0$  is an asymptotically stable spiral point;  $r = 2$  is an unstable limit cycle;  $r = 3$  is a stable limit cycle;  $r = 4$  is an unstable limit cycle. See Fig. **12–U** on page 316.
16. No
18. Asymptotically stable

**FIGURES**



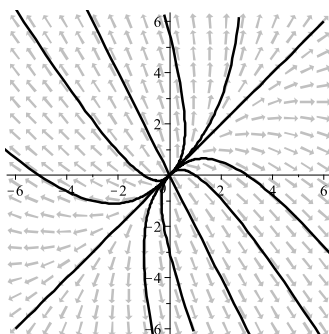
**Figure 12–A:** Phase plane diagram in Problem 14, Section 12.2

---



**Figure 12–B:** Phase plane diagram in Problem 16, Section 12.2

---



**Figure 12–C:** Phase plane diagram in Problem 18, Section 12.2

---

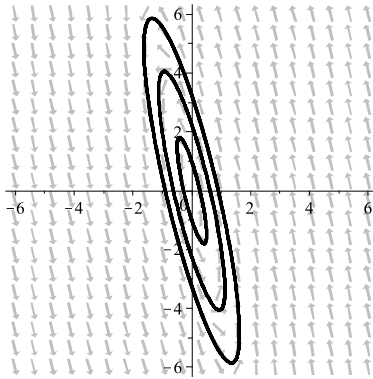


Figure 12–D: Phase plane diagram in Problem 20, Section 12.2

---

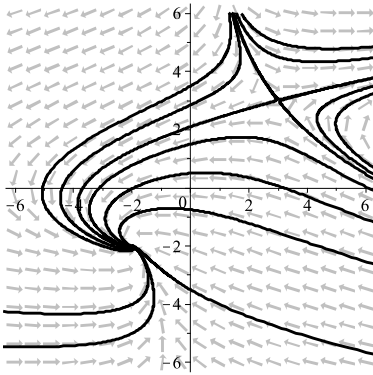


Figure 12–E: Phase plane diagram in Problem 14, Section 12.3

---

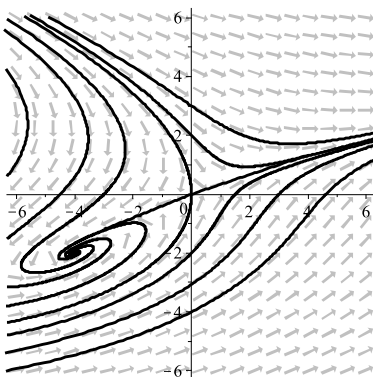
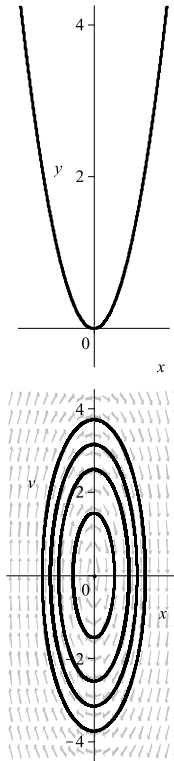


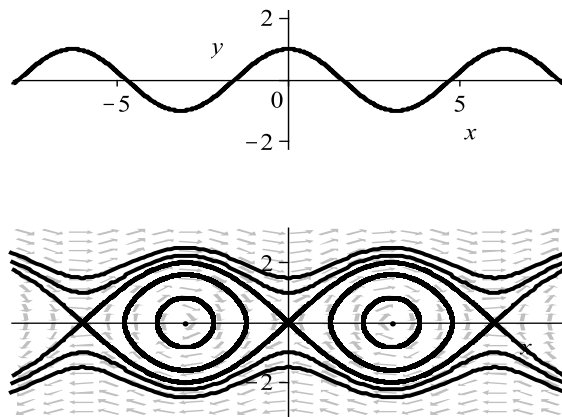
Figure 12–F: Phase plane diagram in Problem 16, Section 12.3

---



**Figure 12–G:** Potential and Phase plane diagrams in Problem 8, Section 12.4

---



**Figure 12–H:** Potential and Phase plane diagrams in Problem 10, Section 12.4

---

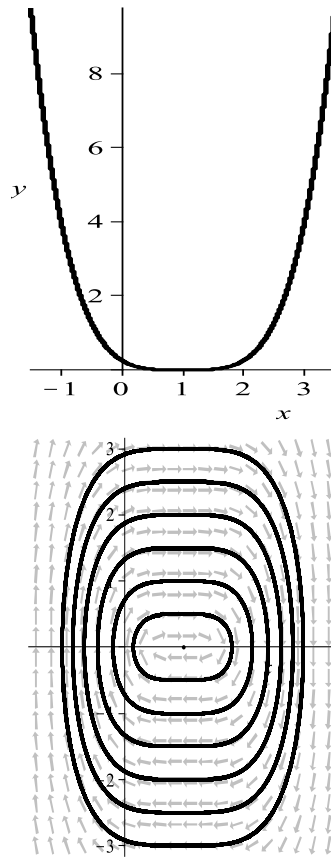


Figure 12–I: Potential and Phase plane diagrams in Problem 12, Section 12.4

---

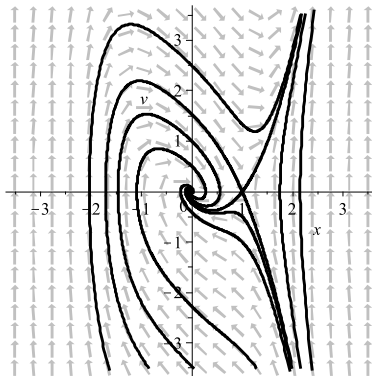


Figure 12–J: Phase plane diagram in Problem 14, Section 12.4

---

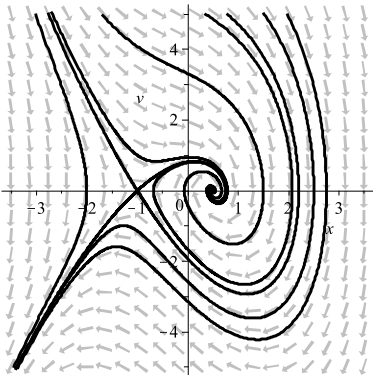


Figure 12–K: Phase plane diagram in Problem 16, Section 12.4

---

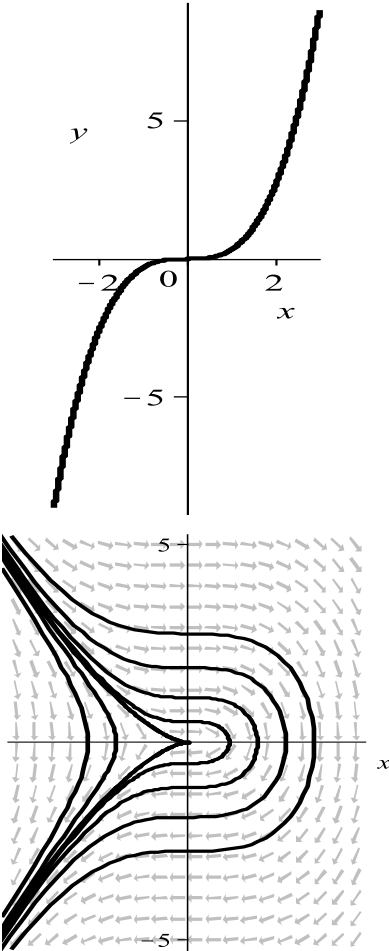
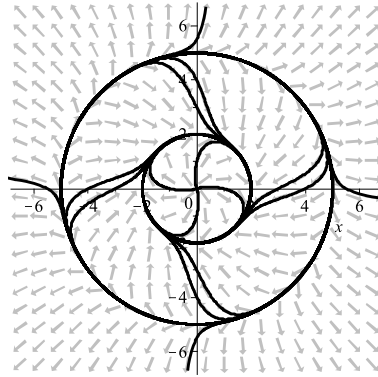


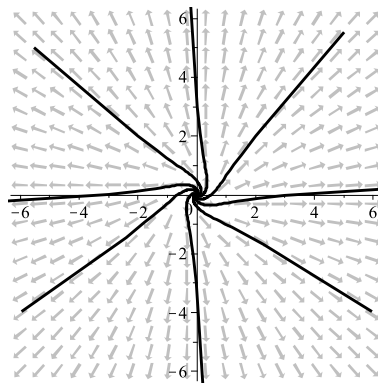
Figure 12–L: Potential and Phase plane diagrams in Problem 18, Section 12.4

---



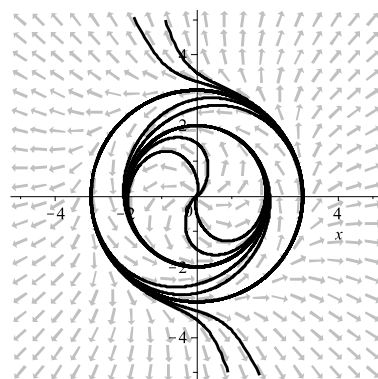
**Figure 12–M:** Phase plane diagram in Problem 6, Section 12.6

---



**Figure 12–N:** Phase plane diagram in Problem 8, Section 12.6

---



**Figure 12–O:** Phase plane diagram in Problem 10, Section 12.6

---

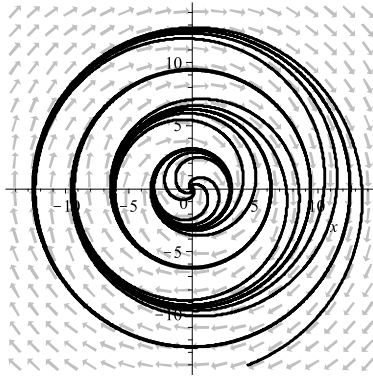


Figure 12–P: Phase plane diagram in Problem 12, Section 12.6

---

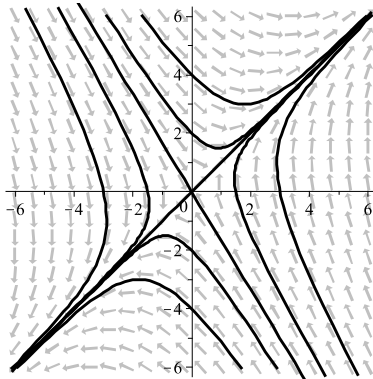


Figure 12–Q: Phase plane diagram in Problem 2, Review Section

---

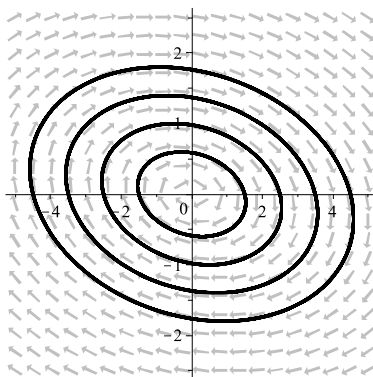
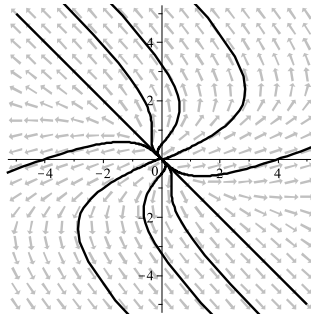


Figure 12–R: Phase plane diagram in Problem 4, Review Section

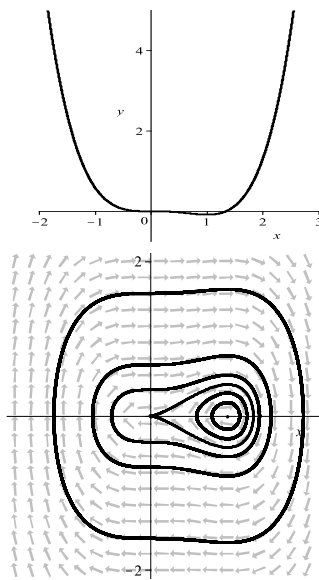
---





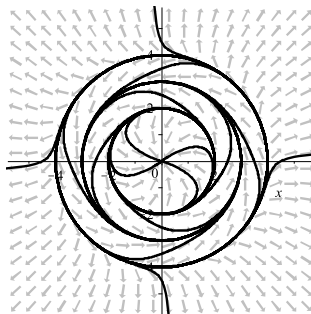
**Figure 12–S:** Phase plane diagram in Problem 6, Review Section

---



**Figure 12–T:** Potential and Phase plane diagrams in Problem 8, Review Section

---



**Figure 12–U:** Phase plane diagram in Problem 14, Review Section

---

## CHAPTER 13: Existence and Uniqueness Theory

### EXERCISES 13.1: Introduction: Successive Approximations

2.  $y(x) = \int_{\pi}^x \sin[t + y(t)] dt$

4.  $y(x) = 1 + \int_0^x e^{y(t)} dt$

6. 0.3775396

8. 2.2360680

10. 1.9345632

12.  $y_1(x) = 1 + x; y_2(x) = 1 + x + x^2 + \left(\frac{1}{3}\right)x^3$

14.  $y_1(x) = y_2(x) = \sin x$

16.  $y_1(x) = \left(\frac{3}{2}\right) - x + \left(\frac{1}{2}\right)x^2;$

$$y_2(x) = \left(\frac{5}{3}\right) - \left(\frac{3}{2}\right)x + x^2 - \left(\frac{1}{6}\right)x^3$$

### EXERCISES 13.2: Picard's Existence and Uniqueness Theorem

2. No

4. Yes

6. Yes

14. No. Let  $y_n(x) = \begin{cases} n^2x, & 0 \leq x \leq (1/n) \\ 2n - n^2x, & (1/n) \leq x \leq (2/n) \\ 0, & 2/n \leq x \leq 1. \end{cases}$

Then

$$\lim_{n \rightarrow \infty} y_n(x) = 0,$$

## Chapter 13

but

$$\lim_{n \rightarrow \infty} \int_0^1 y_n(x) dx = 1 \neq 0.$$

### EXERCISES 13.3: Existence of Solutions of Linear Equations

2.  $[-2, 1)$
4.  $(0, 3]$
6.  $(-\infty, \infty)$

### EXERCISES 13.4: Continuous Dependence of Solutions

2.  $10^{-2}e$
4.  $10^{-2}e^{\sqrt{2}}e^{-1/2}$
6.  $10^{-2}e$
8.  $\left(\frac{1}{24}\right)e^{\sin 1}$
10.  $\frac{e}{6}$

### REVIEW PROBLEMS

2. 0.7390851
4.  $9 + \int_0^x [t^2 y^3(t) - y^2(t)] dt$
6.  $y_1(x) = -1 + 2x$ ;  $y_2(x) = -1 + 2x - 2x^2$
8. No
10.  $\left(-\frac{\pi}{2}, \frac{\pi}{2}\right)$
12.  $\frac{e}{6}$