

Solutions Manual
Accompanying
Elements of Electromagnetics,

Third Edition

Matthew Sadiku, Jerry Sagliocca, and Oladega Soriyan

TABLE OF CONTENTS

Chapter 1	1
Chapter 2	15
Chapter 3	40
Chapter 4	78
Chapter 5	113
Chapter 6	129
Chapter 7	164
Chapter 8	193
Chapter 9	221
Chapter 10	240
Chapter 11	280
Chapter 12	328
Chapter 13	350
Chapter 14	384
Chapter 15	389

CHAPTER 1

P. E. 1.1

$$(a) \quad A + B = (1, 0, 3) + (5, 2, -6) = (6, 2, -3)$$

$$|A + B| = \sqrt{36 + 4 + 9} = \underline{7}$$

$$(b) \quad 5A - B = (5, 0, 15) - (5, 2, -6) = \underline{(0, -2, 21)}$$

$$(c) \quad \text{The component of } A \text{ along } a_y \text{ is } A_y = \underline{0}$$

$$(d) \quad 3A + B = (3, 0, 9) + (5, 2, -6) = (8, 2, 3)$$

A unit vector parallel to this vector is

$$a_{||} = \frac{(8, 2, 3)}{\sqrt{64 + 4 + 9}}$$

$$= \underline{\underline{\pm(0.9117a_x + 0.2279a_y + 0.3419a_z)}}$$

P. E. 1.2 (a) The distance vector

$$r_{QR} = r_R - r_Q = (0, 3, 8) - (2, 4, 6)$$

$$= \underline{\underline{-2a_x - a_y + 2a_z}}$$

$$(b) \quad \text{The distance between Q and R is}$$

$$|r_{QR}| = \sqrt{4 + 1 + 4} = \underline{3}$$

$$(c) \quad \text{Vector } r_{QP} = r_P - r_Q = (1, -3, 5) - (2, 4, 6) = (-1, -7, -1)$$

$$\cos \theta_{PQR} = \frac{r_{QR} \cdot r_{QP}}{|r_{QR}| |r_{QP}|} = \frac{7}{3\sqrt{51}}$$

$$\theta_{PQR} = \underline{\underline{70.93^\circ}}$$

$$(d) \quad \text{Area} = \frac{1}{2} |r_{QR} \times r_{QP}| = \frac{1}{2} |(15, -4, 13)|$$

$$= \underline{\underline{10.12}}$$

P. E. 1.3 Consider the figure shown below:

$$U_z = U_p + U_w = -350a_x + \frac{40}{\sqrt{2}}(-a_x + a_y)$$

$$= -378a_x + 28.28a_y$$

or

$$\mathbf{u} = 379.3 \angle 175.72^\circ$$

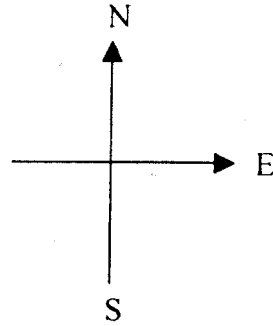
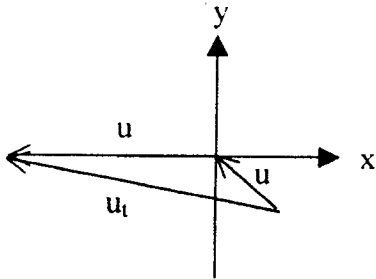

P. E. 1.4

At point (1,0), $\mathbf{G} = \mathbf{a}_y$;

at point (0,1), $\mathbf{G} = -\mathbf{a}_x$;

at point (2,0), $\mathbf{G} = \mathbf{a}_y$;

at point (1,1), $\mathbf{G} = \frac{-\mathbf{a}_x + \mathbf{a}_y}{\sqrt{2}}$; and so on.

It is evident that \mathbf{G} is a unit vector at each point. Thus the vector field \mathbf{G} is as sketched in Fig. 1.8.

P. E. 1.5

Using the dot product,

$$\cos \theta_{AB} = \frac{\mathbf{A} \cdot \mathbf{B}}{AB} = \frac{-13}{\sqrt{10}\sqrt{65}} = -\sqrt{\frac{13}{50}}$$

or using the cross product,

$$\sin \theta_{AB} = \frac{|\mathbf{A} \times \mathbf{B}|}{AB} = \sqrt{\frac{481}{650}}$$

Either way,

$$\underline{\underline{\theta_{AB} = 120.66^\circ}}$$

P. E. 1.6

$$(a) E_F = (E \cdot a_F) a_F = \frac{(E \cdot F)F}{|F|^2} = \frac{-10(4, -10, 5)}{141}$$

$$= \underline{\underline{-0.2837a_x + 0.7092a_y - 0.3546a_z}}$$

$$(b) E \times F = \begin{vmatrix} a_x & a_y & a_z \\ 0 & 3 & 4 \\ 4 & -10 & 5 \end{vmatrix} = (55, 16, -12)$$

$$a_{E \times F} = \underline{\underline{\pm(0.9398, 0.2734, -0.205)}}$$

P. E. 1.7 $a + b + c = 0$ showing that a , b , and c form the sides of a triangle.

$$a \cdot b = 0,$$

hence it is a right angle triangle.

$$\text{Area} = \frac{1}{2}|a \times b| = \frac{1}{2}|b \times c| = \frac{1}{2}|c \times a|$$

$$\frac{1}{2}|a \times b| = \frac{1}{2} \begin{vmatrix} 4 & 0 & -1 \\ 1 & 3 & 4 \end{vmatrix} = \frac{1}{2}|(3, -17, 12)|$$

$$\text{Area} = \frac{1}{2}\sqrt{9 + 289 + 144} = \underline{\underline{10.51}}$$

P. E. 1.8

$$(a) P_1 P_2 = \sqrt{(x_2 - x_1)^2 + (y_2 - y_1)^2 + (z_2 - z_1)^2}$$

$$= \sqrt{25 + 4 + 64} = \underline{\underline{9.644}}$$

$$(b) r_P = r_{P_1} + \lambda(r_{P_2} - r_{P_1})$$

$$= (1, 2, -3) + \lambda(-5, -2, 8)$$

$$= \underline{\underline{(1 - 5\lambda, 2 - 2\lambda, -3 + 8\lambda)}}$$

(c) The shortest distance is

$$d = P_1 P_3 \sin \theta = |P_1 P_3 \times a_{P_1 P_2}|$$

$$= \frac{1}{\sqrt{93}} \begin{vmatrix} 6 & -3 & 5 \\ -5 & -2 & 8 \end{vmatrix}$$

$$= \frac{1}{\sqrt{93}} |(-14, -73, -27)| = \underline{\underline{8.2}}$$

Prob. 1.1

$$\mathbf{r} = (-3, 2, 2) - (2, 4, 4) = (-5, -2, -2)$$

$$\mathbf{a}_r = \frac{\mathbf{r}}{|\mathbf{r}|} = \frac{(-5, -2, -2)}{\sqrt{25 + 4 + 4}} = -0.8703\mathbf{a}_x - 0.3482\mathbf{a}_y - 0.3482\mathbf{a}_z$$

Prob. 1.2

$$(a) \mathbf{A} + 2\mathbf{B} = (2, 5, -3) + (6, -8, 0) = \underline{\underline{8\mathbf{a}_x - 3\mathbf{a}_y - 3\mathbf{a}_z}}$$

$$(b) \mathbf{A} - 5\mathbf{C} = (2, 5, -3) - (5, 5, 5) = (-3, 0, -8)$$

$$|\mathbf{A} - 5\mathbf{C}| = \sqrt{9 + 0 + 64} = \underline{\underline{8.544}}$$

$$(c) k\mathbf{B} = 3k\mathbf{a}_x - 4k\mathbf{a}_y$$

$$|k\mathbf{B}| = \sqrt{9k^2 + 16k^2} = \pm 5k = 2$$

$$\Rightarrow \underline{\underline{k = \pm 0.4}}$$

$$(d) \mathbf{A} \cdot \mathbf{B} = (2, 5, -3) \cdot (3, -4, 0) = 6 - 20 + 0 = 14$$

$$\mathbf{A} \times \mathbf{B} = \begin{vmatrix} 2 & 5 & -3 \\ 3 & -4 & 0 \end{vmatrix} = (-12, -9, -23)$$

$$\frac{\mathbf{A} \times \mathbf{B}}{\mathbf{A} \cdot \mathbf{B}} = \left(\frac{12}{14}, \frac{9}{14}, \frac{23}{14} \right) = \underline{\underline{0.8571\mathbf{a}_x + 0.6428\mathbf{a}_y + 1.642\mathbf{a}_z}}$$

Prob. 1.3

$$(a) \mathbf{A} - 2\mathbf{B} = (2, 1, -3) - (0, 2, -2) = (2, -1, -1)$$

$$\mathbf{A} - 2\mathbf{B} + \mathbf{C} = \underline{\underline{5\mathbf{a}_x + 4\mathbf{a}_y + 6\mathbf{a}_z}}$$

$$(b) \mathbf{A} + \mathbf{B} = (2, 2, -4)$$

$$\mathbf{C} - 4(\mathbf{A} + \mathbf{B}) = (3, 5, 7) - (8, 8, -16) = \underline{\underline{-5\mathbf{a}_x - 3\mathbf{a}_y + 23\mathbf{a}_z}}$$

$$(c) 2\mathbf{A} - 3\mathbf{B} = (4, 2, -6) - (0, 3, -3) = (4, -1, -3)$$

$$|\mathbf{C}| = \sqrt{9 + 25 + 49} = 9.11$$

$$\frac{2\mathbf{A} - 3\mathbf{B}}{|\mathbf{C}|} = \underline{\underline{0.439\mathbf{a}_x - 0.11\mathbf{a}_y - 0.3293\mathbf{a}_z}}$$

$$(d) A \cdot C = 6 + 5 - 21 = -10,$$

$$|B| = \sqrt{2}$$

$$A \cdot C - |B|^2 = -10 + 2 = \underline{\underline{-8}}$$

$$(e) \frac{1}{3}A + \frac{1}{4}C = \left(\frac{2}{3}, \frac{1}{3}, -1\right) + \left(\frac{3}{4}, \frac{5}{4}, \frac{7}{4}\right) = (1.4167, 1.5833, 0.75)$$

$$\frac{1}{2}B \times \left(\frac{1}{3}A + \frac{1}{4}C\right) = \frac{1}{2} \begin{vmatrix} 0 & 1 & -1 \\ 1.4167 & 1.5833 & 0.75 \end{vmatrix} = \underline{\underline{1.1667a_x - 0.7084a_y - 0.7084a_z}}$$

Prob. 1.4

$$(a) \quad T = (3, -2, 1) \text{ and } S = (4, 6, 2)$$

$$(b) \quad r_{TS} = r_s - r_t = (4, 6, 2) - (3, -2, 1) = \underline{\underline{a_x + 8a_y + a_z}}$$

$$(c) \quad \text{distance} = |r_{TS}| = \sqrt{1 + 64 + 1} = \underline{\underline{8.124 \text{ m}}}$$

Prob. 1.5

$$\text{Let } D = \alpha A + \beta B + C$$

$$= (5\alpha - \beta + 8)a_x + (3\alpha + 4\beta + 2)a_y + (-2\alpha + 6\beta)a_z$$

$$D_x = 0 \rightarrow 5\alpha - \beta + 8 = 0 \quad (1)$$

$$D_z = 0 \rightarrow -2\alpha + 6\beta = 0 \rightarrow \alpha = 3\beta \quad (2)$$

Substituting (2) into (1),

$$15\beta - \beta + 8 = 0 \rightarrow \beta = -\frac{8}{14} = -\frac{4}{7}$$

Thus

$$\underline{\underline{\alpha = -\frac{12}{7}, \beta = -\frac{4}{7}}}$$

Prob. 1.6

$$A \cdot B = 0 \rightarrow 0 = 3\alpha + \beta - 24 \quad (1)$$

$$A \cdot C = 0 \rightarrow 0 = 5\alpha - 2 + 4\gamma \quad (2)$$

$$B \cdot C = 0 \rightarrow 0 = 15 - 2\beta - 6\gamma \quad (3)$$

In matrix form,

$$\begin{bmatrix} 24 \\ 2 \\ 15 \end{bmatrix} = \begin{bmatrix} 3 & 1 & 0 \\ 5 & 0 & 4 \\ 0 & 2 & 6 \end{bmatrix} \begin{bmatrix} \alpha \\ \beta \\ \gamma \end{bmatrix}$$

$$\Delta = \begin{vmatrix} 3 & 1 & 0 \\ 5 & 0 & 4 \\ 0 & 2 & 6 \end{vmatrix} = 3(0-8) - 1(30-0) + 0(10-0) = -24 - 30 = -54$$

$$\Delta_1 = \begin{vmatrix} 24 & 1 & 0 \\ 2 & 0 & 4 \\ 15 & 2 & 6 \end{vmatrix} = -24 \times 8 - (12 - 60) = -144$$

$$\Delta_2 = \begin{vmatrix} 3 & 24 & 0 \\ 5 & 2 & 4 \\ 0 & 15 & 6 \end{vmatrix} = 3(12 - 60) - 24 \times 30 = -864$$

$$\Delta_3 = \begin{vmatrix} 3 & 1 & 24 \\ 5 & 0 & 2 \\ 0 & 2 & 15 \end{vmatrix} = -12 - 75 + 240 = 153$$

$$\alpha = \frac{\Delta_1}{\Delta} = \frac{-144}{-54} = \underline{\underline{2.667}}$$

$$\beta = \frac{\Delta_2}{\Delta} = \frac{-864}{-54} = \underline{\underline{16}}$$

$$\gamma = \frac{\Delta_3}{\Delta} = \frac{153}{-54} = \underline{\underline{-2.833}}$$

Prob. 1.7

$$(a) A \cdot B = AB \cos \theta_{AB}$$

$$A \times B = AB \sin \theta_{AB} \mathbf{a}_n$$

$$(A \cdot B)^2 + |A \times B|^2 = (AB)^2 (\cos^2 \theta_{AB} + \sin^2 \theta_{AB}) = (AB)^2$$

(b) $a_x \cdot (a_y \times a_z) = a_x \cdot a_x = 1$. Hence,

$$\frac{a_y \times a_z}{a_x \cdot a_y \times a_z} = \frac{a_x}{1} = a_x$$

$$\frac{a_z \times a_x}{a_x \cdot a_y \times a_z} = \frac{a_y}{1} = a_y$$

$$\frac{a_x \times a_y}{a_x \cdot a_y \times a_z} = \frac{a_z}{1} = a_z$$

Prob. 1.8

(a) $P + Q = (2, 2, 0)$, $P + Q - R = (3, 1, -2)$

$$|P + Q - R| = \sqrt{9 + 1 + 4} = \sqrt{14} = \underline{\underline{3.742}}$$

$$(b) P \cdot Q \times R = \begin{vmatrix} -2 & -1 & -2 \\ 4 & 3 & 2 \\ -1 & 1 & 2 \end{vmatrix} = -2(6 - 2) + (8 + 2) - 2(4 + 3) = -8 + 10 - 14 = \underline{\underline{-12}}$$

$$Q \times R = \begin{vmatrix} 4 & 3 & 2 \\ -1 & 1 & 2 \end{vmatrix} = (4, -10, 7)$$

$$P \cdot Q \times R = (-2, -1, -2) \cdot (4, -10, 7) = -8 + 10 - 14 = \underline{\underline{-12}}$$

$$(c) Q \times P = \begin{vmatrix} 4 & 3 & 2 \\ -2 & -1 & -2 \end{vmatrix} = (-4, 4, 2)$$

$$Q \times P \cdot R = (-4, 4, 2) \cdot (-1, 1, 2) = 4 + 4 + 4 = \underline{\underline{12}}$$

$$\text{or } Q \times P \cdot R = R \cdot Q \times P = \begin{vmatrix} -1 & 1 & 2 \\ 4 & 3 & 2 \\ -2 & -1 & -2 \end{vmatrix} = -(-6 + 2) - (-8 + 4) + 2(-4 + 6) = \underline{\underline{12}}$$

$$(d) (P \times Q) \cdot (Q \times R) = (4, -4, 2) \cdot (4, -10, 7) = 16 + 40 - 14 = \underline{\underline{42}}$$

$$(e) (P \times Q) \times (Q \times R) = \begin{vmatrix} 4 & -4 & 2 \\ 4 & -10 & 7 \end{vmatrix} = \underline{\underline{-48a_x - 36a_y - 24a_z}}$$

$$(f) \cos \theta_{PR} = \frac{P \cdot R}{|P||R|} = \frac{(2-1-4)}{\sqrt{4+1+4}\sqrt{1+1+4}} = \frac{-3}{3\sqrt{6}} = \frac{-1}{\sqrt{6}}$$

$$\underline{\underline{\theta_{PR} = 114.1^\circ}}$$

$$(g) \sin \theta_{PQ} = \frac{|\mathbf{P} \times \mathbf{Q}|}{|\mathbf{P}||\mathbf{Q}|} = \frac{\sqrt{16+16+4}}{3\sqrt{16+9+4}} = \frac{6}{3\sqrt{29}}$$

$$\theta_{PQ} = \underline{\underline{21.8^\circ}}$$

Prob. 1.9

$$(a) T_s = \mathbf{T} \cdot \mathbf{a}_s = \frac{\mathbf{T} \cdot \mathbf{S}}{|\mathbf{S}|} = \frac{(2, -6, -3) \cdot (1, 2, 1)}{\sqrt{6}} = \frac{-7}{\sqrt{6}} = \underline{\underline{-2.8577}}$$

$$(b) \mathbf{S}_T = (\mathbf{S} \cdot \mathbf{a}_T) \mathbf{a}_T = \frac{(\mathbf{S} \cdot \mathbf{T}) \mathbf{T}}{T^2} = \frac{-7(2, -6, 3)}{7^2}$$

$$= \underline{\underline{-0.2857\mathbf{a}_x + 0.8571\mathbf{a}_y - 0.4286\mathbf{a}_z}}$$

$$(c) \sin \theta_{TS} = \frac{|\mathbf{T} \times \mathbf{S}|}{|\mathbf{T}||\mathbf{S}|} = \frac{\begin{vmatrix} 2 & -6 & 3 \\ 1 & 2 & 1 \end{vmatrix}}{7\sqrt{6}} = \frac{|(-12, 1, 10)|}{7\sqrt{6}} = \frac{\sqrt{245}}{7\sqrt{6}} = 0.9129$$

$$\Rightarrow \theta_{TS} = \underline{\underline{65.91^\circ}}$$

Prob. 1.10

$$(a) A_B = \mathbf{A} \cdot \mathbf{a}_B = \frac{\mathbf{A} \cdot \mathbf{B}}{|\mathbf{B}|} = \frac{-1+12+15}{\sqrt{1+4+9}} = \frac{26}{\sqrt{14}} = \underline{\underline{6.95}}$$

$$(b) \mathbf{B}_A = (\mathbf{B} \cdot \mathbf{a}_A) \mathbf{a}_A = \frac{(\mathbf{B} \cdot \mathbf{A}) \mathbf{A}}{|\mathbf{A}|^2} = \frac{26(-1, 6, 5)}{(1+36+25)}$$

$$= \underline{\underline{-0.4193\mathbf{a}_x + 2.516\mathbf{a}_y + 2.097\mathbf{a}_z}}$$

$$(c) \cos \theta_{AB} = \frac{\mathbf{A} \cdot \mathbf{B}}{|\mathbf{A}||\mathbf{B}|} = \frac{26}{\sqrt{62}\sqrt{1+4+9}} = \frac{26}{\sqrt{62}\sqrt{14}}$$

$$\theta_{AB} = \underline{\underline{28.05^\circ}}$$

$$(d) \mathbf{A} \times \mathbf{B} = \begin{vmatrix} -1 & 6 & 5 \\ 1 & 2 & 3 \end{vmatrix} = 8\mathbf{a}_x + 8\mathbf{a}_y - 8\mathbf{a}_z$$

A unit vector perpendicular to both \mathbf{A} and \mathbf{B} is

$$\mathbf{a}_{A \times B} = \frac{8\mathbf{a}_x + 8\mathbf{a}_y - 8\mathbf{a}_z}{8\sqrt{1+1+1}} = \frac{\mathbf{a}_x + \mathbf{a}_y - \mathbf{a}_z}{\sqrt{3}} = \underline{\underline{0.577\mathbf{a}_x + 0.577\mathbf{a}_y - 0.577\mathbf{a}_z}}$$

Prob. 1.11

$$\cos \theta = \frac{\mathbf{H} \cdot \mathbf{a}_x}{|\mathbf{H}|} = \frac{3}{\sqrt{9+25+64}} = \frac{3}{98}$$

$$\theta_x = \underline{\underline{72.36^\circ}}$$

$$\cos \theta = \frac{\mathbf{H} \cdot \mathbf{a}_y}{|\mathbf{H}|} = \frac{5}{\sqrt{9+25+64}} = \frac{5}{98}$$

$$\theta_y = \underline{\underline{59.66^\circ}}$$

$$\cos \theta = \frac{\mathbf{H} \cdot \mathbf{a}_z}{|\mathbf{H}|} = \frac{-8}{\sqrt{9+25+64}} = \frac{-8}{98}$$

$$\theta_z = \underline{\underline{143.91^\circ}}$$

Prob. 1.12

$$\mathbf{Q} \times \mathbf{R} = \begin{vmatrix} 1 & 1 & 1 \\ 2 & 0 & 3 \end{vmatrix} = (3, -1, -2)$$

$$\mathbf{P} \cdot (\mathbf{Q} \times \mathbf{R}) = (2, -1, 1) \cdot (3, -1, 2) = 6 + 1 - 2 = \underline{\underline{5}}$$

Prob. 1.13

(a) Using the fact that

$$(\mathbf{A} \times \mathbf{B}) \times \mathbf{C} = (\mathbf{A} \cdot \mathbf{C})\mathbf{B} - (\mathbf{B} \cdot \mathbf{C})\mathbf{A},$$

we get

$$\mathbf{A} \times (\mathbf{A} \times \mathbf{B}) = -(\mathbf{A} \times \mathbf{B}) \times \mathbf{A} = \underline{\underline{(\mathbf{B} \cdot \mathbf{A})\mathbf{A} - (\mathbf{A} \cdot \mathbf{A})\mathbf{B}}}$$

$$\begin{aligned} \text{(b) } \mathbf{A} \times (\mathbf{A} \times (\mathbf{A} \times \mathbf{B})) &= \mathbf{A} \times [(\mathbf{A} \cdot \mathbf{B})\mathbf{A} - (\mathbf{A} \cdot \mathbf{A})\mathbf{B}] \\ &= \underline{\underline{(\mathbf{A} \cdot \mathbf{B})(\mathbf{A} \times \mathbf{A}) - (\mathbf{A} \cdot \mathbf{A})(\mathbf{A} \times \mathbf{B})}} \end{aligned}$$

Prob. 1.14

$$\mathbf{A} \cdot (\mathbf{B} \times \mathbf{C}) = \begin{vmatrix} A_x & A_y & A_z \\ B_x & B_y & B_z \\ C_x & C_y & C_z \end{vmatrix}, \quad (\mathbf{A} \times \mathbf{B}) \cdot \mathbf{C} = \begin{vmatrix} A_x & A_y & A_z \\ B_x & B_y & B_z \\ C_x & C_y & C_z \end{vmatrix}$$

Hence, $\mathbf{A} \cdot (\mathbf{B} \times \mathbf{C}) = (\mathbf{A} \times \mathbf{B}) \cdot \mathbf{C}$

Prob. 1.15

$$P_1P_2 = r_{P_2} - r_{P_1} = (-6, 0, -3)$$

$$P_1P_3 = r_{P_3} - r_{P_1} = (1, 5, -6)$$

$$P_1P_2 \times P_1P_3 = \begin{vmatrix} -6 & 0 & -3 \\ 1 & 5 & -6 \end{vmatrix} = (15, 39, -30)$$

$$\text{Area of the triangle} = \frac{1}{2} |P_1P_2 \times P_1P_3| = \frac{1}{2} \sqrt{15^2 + 39^2 + 30^2} = \underline{\underline{25.72}}$$

Prob. 1.16

Let $P_1 = (4, 1, -3)$, $P_2 = (-2, 5, 4)$, and $P_3 = (0, 1, 6)$

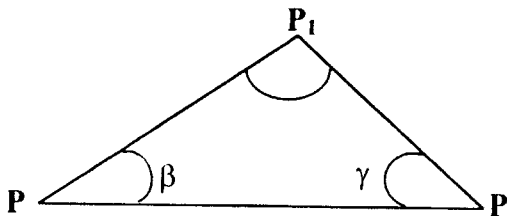

$$a = r_{P_2} - r_{P_1} = (-2, 5, 4) - (4, 1, -3) = (-6, 4, 7)$$

$$b = r_{P_3} - r_{P_2} = (0, 1, 6) - (-2, 5, 4) = (2, -4, 2)$$

$$c = r_{P_1} - r_{P_3} = (4, 1, -3) - (0, 1, 6) = (4, 0, -9)$$

Note that $a + b + c = 0$

$$a \cdot b = ab \cos(180 - \gamma) \rightarrow -\cos \gamma = \frac{a \cdot b}{|a||b|} = \frac{-12 - 16 + 14}{\sqrt{101}\sqrt{24}}$$

$$\gamma = \cos^{-1} \frac{14}{\sqrt{101}\sqrt{24}} = \underline{\underline{73.47^\circ}}$$

$$b \cdot c = bc \cos(180 - \beta) \rightarrow -\cos \beta = \frac{b \cdot c}{|b||c|} = \frac{8 + 0 - 18}{\sqrt{24}\sqrt{97}}$$

$$\beta = \cos^{-1} \frac{10}{\sqrt{24}\sqrt{97}} = \underline{\underline{78.04^\circ}}$$

$$a \cdot c = ac \cos(180 - \alpha) \rightarrow -\cos \alpha = \frac{a \cdot c}{|a||c|} = \frac{-24 + 0 - 63}{\sqrt{101}\sqrt{97}}$$

$$\alpha = \cos^{-1} \frac{87}{\sqrt{101}\sqrt{97}} = \underline{\underline{28.48^\circ}}$$

Prob. 1.17

$$(a) \mathbf{r}_{PQ} = \mathbf{r}_Q - \mathbf{r}_P = (2, -1, 3) - (-1, 4, 8) = (3, -5, -5)$$

$$r_{PQ} = |\mathbf{r}_{PQ}| = \sqrt{9 + 25 + 25} = \underline{7.681}$$

$$(b) \mathbf{r}_{PR} = \mathbf{r}_R - \mathbf{r}_P = (-1, 2, 3) - (-1, 4, 8) = (0, -2, -5) = \underline{\underline{-2\mathbf{a}_y - 5\mathbf{a}_z}}$$

$$(c) \mathbf{r}_{QP} = -\mathbf{r}_{PQ} = -3\mathbf{a}_x + 5\mathbf{a}_y + 5\mathbf{a}_z$$

$$\mathbf{r}_{QR} = \mathbf{r}_Q - \mathbf{r}_R = (2, -1, 3) - (-1, 2, 3) = 3\mathbf{a}_x - 3\mathbf{a}_y$$

$$\cos \theta = \frac{\mathbf{r}_{QP} \cdot \mathbf{r}_{QR}}{|\mathbf{r}_{QP}| |\mathbf{r}_{QR}|} = \frac{-9 - 15}{\sqrt{9 + 25 + 25} \sqrt{9 + 9}} = \frac{-24}{\sqrt{18} \sqrt{59}}$$

$$\underline{\theta = 137.43^\circ}$$

$$(d) \text{Area} = \frac{1}{2} |\mathbf{r}_{QP} \times \mathbf{r}_{QR}|$$

$$\mathbf{r}_{QP} \times \mathbf{r}_{QR} = \begin{vmatrix} -3 & 5 & 5 \\ 3 & -3 & 0 \end{vmatrix} = 15\mathbf{a}_x + 15\mathbf{a}_y - 6\mathbf{a}_z$$

$$\text{Area} = \frac{1}{2} \sqrt{15^2 + 15^2 + 6^2} = \underline{11.02}$$

$$(e) \text{Perimeter} = QP + PR + RQ = r_{QP} + r_{PR} + r_{QR}$$

$$= \sqrt{59} + \sqrt{4 + 25} + \sqrt{18}$$

$$= 7.681 + 5.385 + 4.243$$

$$= \underline{17.31}$$

Prob. 1.18

$$(a) \text{ Let } \mathbf{A} = (A, B, C) \text{ and } \mathbf{r} = (x, y, z)$$

$$(\mathbf{r} - \mathbf{A}) \cdot \mathbf{A} = (x - A)A + (y - B)B + (z - C)C$$

$$= Ax + By + Cz + D$$

$$\text{where } D = -A^2 - B^2 - C^2. \text{ Hence,}$$

$$(\mathbf{r} - \mathbf{A}) \cdot \mathbf{A} = 0 \rightarrow Ax + By + Cz + D = 0$$

which is the equation of a plane.

$$(b) (\mathbf{r} - \mathbf{A}) \cdot \mathbf{r} = (x - A)x + (y - B)y + (z - C)z$$

$$\text{If } (\mathbf{r} - \mathbf{A}) \cdot \mathbf{r} = 0, \text{ then}$$

$$x^2 + y^2 + z^2 - Ax - By - Cz = 0$$

which is the equation of a sphere whose surface touches the origin.

$$(c) \text{ See parts (a) and (b).}$$

Prob. 1.19

(a) Let P and Q be as shown below:

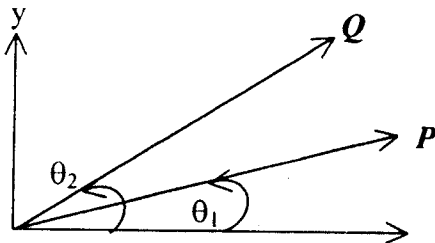

$$|P| = \cos^2 \theta_1 + \sin^2 \theta_1 = 1, |Q| = \cos^2 \theta_2 + \sin^2 \theta_2 = 1,$$

Hence P and Q are unit vectors.

$$(b) P \cdot Q = (1)(1)\cos(\theta_2 - \theta_1)$$

But $P \cdot Q = \cos \theta_1 \cos \theta_2 + \sin \theta_1 \sin \theta_2$. Thus,

$$\underline{\underline{\cos(\theta_2 - \theta_1) = \cos \theta_1 \cos \theta_2 + \sin \theta_1 \sin \theta_2}}$$

Let $P_1 = P = \cos \theta_1 a_x + \sin \theta_1 a_y$, and

$$Q_1 = \cos \theta_2 a_x - \sin \theta_2 a_y.$$

P_1 and Q_1 are unit vectors as shown below:

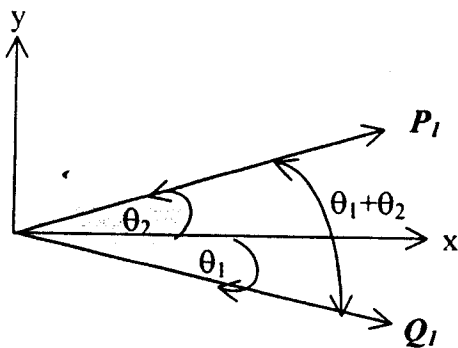

$$P_1 \cdot Q_1 = (1)(1)\cos(\theta_1 + \theta_2)$$

But $P_1 \cdot Q_1 = \cos \theta_1 \cos \theta_2 - \sin \theta_1 \sin \theta_2$,

$$\underline{\underline{\cos(\theta_2 + \theta_1) = \cos \theta_1 \cos \theta_2 - \sin \theta_1 \sin \theta_2}}$$

Alternatively, we can obtain this formula from the previous one by replacing θ_2 by $-\theta_2$ in Q .

(c)

$$\begin{aligned} \frac{1}{2}|P-Q| &= \frac{1}{2}|(\cos\theta_1 - \cos\theta_2)a_x + (\sin\theta_1 - \sin\theta_2)a_y| \\ &= \frac{1}{2}\sqrt{\cos^2\theta_1 + \sin^2\theta_1 + \cos^2\theta_2 + \sin^2\theta_2 - 2\cos\theta_1\cos\theta_2 - 2\sin\theta_1\sin\theta_2} \\ &= \frac{1}{2}\sqrt{2 - 2(\cos\theta_1\cos\theta_2 + \sin\theta_1\sin\theta_2)} = \frac{1}{2}\sqrt{2 - 2\cos(\theta_2 - \theta_1)} \end{aligned}$$

Let $\theta_2 - \theta_1 = \theta$, the angle between **P** and **Q**.

$$\frac{1}{2}|P-Q| = \frac{1}{2}\sqrt{2-2\cos\theta}$$

But $\cos 2A = 1 - 2\sin^2 A$.

$$\frac{1}{2}|P-Q| = \frac{1}{2}\sqrt{2-2+4\sin^2\theta/2} = \sin\theta/2$$

Thus,

$$\frac{1}{2}|P-Q| = \left| \sin \frac{\theta_2 - \theta_1}{2} \right|$$

Prob. 1.20

$$\mathbf{w} = \frac{w(1,-2,2)}{3} = (1,-2,2), \quad \mathbf{r} = \mathbf{r}_p - \mathbf{r}_o = (1,3,4) - (2,-3,1) = (-1,6,3)$$

$$\mathbf{u} = \mathbf{w} \times \mathbf{r} = \begin{vmatrix} 1 & -2 & 2 \\ -1 & 6 & 3 \end{vmatrix} = (-18, -5, 4)$$

$$\underline{\underline{\mathbf{u} = -18\mathbf{a}_x - 5\mathbf{a}_y + 4\mathbf{a}_z}}$$

Prob. 1.21

(a) At *T*, $\mathbf{A} = (-4, 3, -9)$

$$|\mathbf{A}| = \sqrt{16+9+81} = \sqrt{106} = \underline{\underline{10.3}}$$

(b) Let $r_{TS} = B = Ba_B$

$$B = 5.6, a_B = a_A = \frac{(-4, 3, -9)}{10.3}$$

$$\begin{aligned} r_{TS} = B &= \frac{5.6(-4, 3, 9)}{10.3} \\ &= \underline{\underline{-2.175a_x + 1.631a_y - 4.893a_z}} \end{aligned}$$

(c) $r_{TS} = r_S - r_T \rightarrow r_S = r_T + r_{TS}$

$$\therefore \underline{\underline{r_S = -0.175a_x + 0.631a_y - 1.893a_z}}$$

Prob. 1.22

(a) At (1,2,3), $E = (2,1,6)$

$$|E| = \sqrt{4+1+36} = \sqrt{41} = \underline{\underline{6.403}}$$

(b) At (1,2,3), $F = (2,-4,6)$

$$\begin{aligned} E_F &= (E \cdot a_F)a_F = \frac{(E \cdot F)F}{|F|^2} = \frac{36}{56}(2, -4, 6) \\ &= \underline{\underline{1.286a_x - 2.571a_y + 3.857a_z}} \end{aligned}$$

(c) At (0,1,-3), $E = (0,1,-3)$, $F = (0,-1,0)$

$$E \times F = \begin{vmatrix} 0 & 1 & -3 \\ 0 & -1 & 0 \end{vmatrix} = (-3, 0, 0)$$

$$a_{E \times F} = \pm \frac{E \times F}{|E \times F|} = \underline{\underline{\pm a_x}}$$

CHAPTER 2

P. E. 2.1

(a) At P(1,3,5), $x = 1$, $y = 3$, $z = 5$,

$$\rho = \sqrt{x^2 + y^2} = \sqrt{10}, \quad z = 5, \quad \phi = \tan^{-1} y/x = 3$$

$$P(\rho, \phi, z) = P(\sqrt{10}, \tan^{-1} 3, 5) = \underline{\underline{P(3.162, 71.6^\circ, 5)}}$$

Spherical system:

$$r = \sqrt{x^2 + y^2 + z^2} = \sqrt{35} = 5.916$$

$$r = \sqrt{x^2 + y^2 + z^2} = \sqrt{35} = 5.916$$

$$\theta = \tan^{-1} \sqrt{x^2 + y^2} / z = \tan^{-1} \sqrt{10} / 5 = \tan^{-1} 0.6325 = 32.31^\circ$$

$$P(r, \theta, \phi) = \underline{\underline{P(5.916, 32.31^\circ, 71.56^\circ)}}$$

At T(0,-4,3), $x = 0$, $y = -4$, $z = 3$;

$$\rho = \sqrt{x^2 + y^2} = 4, z = 3, \phi = \tan^{-1} y/x = \tan^{-1} -4/0 = 270^\circ$$

$$T(\rho, \phi, z) = \underline{\underline{T(4, 270^\circ, 3)}}.$$

Spherical system:

$$r = \sqrt{x^2 + y^2 + z^2} = 5, \theta = \tan^{-1} \rho/z = \tan^{-1} 4/3 = 53.13^\circ.$$

$$T(r, \theta, \phi) = \underline{\underline{T(5, 53.13^\circ, 270^\circ)}}.$$

At S(-3-4-10), $x = -3$, $y = -4$, $z = -10$;

$$\rho = \sqrt{x^2 + y^2} = 5, \phi = \tan^{-1} -4/-3 = 233.1^\circ$$

$$S(\rho, \phi, z) = \underline{\underline{S(5, 233.1^\circ, -10)}}.$$

Spherical system:

$$r = \sqrt{x^2 + y^2 + z^2} = 5\sqrt{5} = 11.18.$$

$$\theta = \tan^{-1} \rho/z = \tan^{-1} 5/-10 = 153.43^\circ;$$

$$S(r, \theta, \phi) = \underline{\underline{S(11.18, 153.43^\circ, 233.1^\circ)}}.$$

(b) In Cylindrical system, $\rho = \sqrt{x^2 + y^2}$; $yz = z\rho \sin \theta$,

$$Q_x = \frac{\rho}{\sqrt{\rho^2 + z^2}}; \quad Q_y = 0; \quad Q_z = \frac{z\rho \sin \phi}{\sqrt{\rho^2 + z^2}};$$

$$\begin{bmatrix} Q_\rho \\ Q_\phi \\ Q_z \end{bmatrix} = \begin{bmatrix} \cos\phi & \sin\phi & 0 \\ -\sin\phi & \cos\phi & 0 \\ 0 & 0 & 1 \end{bmatrix} \begin{bmatrix} Q_x \\ 0 \\ Q_z \end{bmatrix};$$

$$Q_\rho = Q_x \cos\phi = \frac{\rho \cos\phi}{\sqrt{\rho^2 + z^2}}, \quad Q_\phi = -Q_x \sin\phi = \frac{-\rho \sin\phi}{\sqrt{\rho^2 + z^2}}$$

Hence,

$$\bar{Q} = \frac{\rho}{\sqrt{x^2 + z^2}} (\cos\phi \bar{a}_\rho, -\sin\phi \bar{a}_\phi, -z \sin\phi \bar{a}_z).$$

In Spherical coordinates:

$$Q_x = \frac{r \sin\phi}{r} = \sin\phi;$$

$$Q_z = -r \sin\phi \sin\theta r \cos\theta \frac{1}{r} = -r \sin\theta \cos\theta \sin\phi.$$

$$\begin{bmatrix} Q_r \\ Q_\theta \\ Q_\phi \end{bmatrix} = \begin{bmatrix} \sin\theta \cos\phi & \sin\theta \sin\phi & \cos\theta \\ \cos\theta \cos\phi & \cos\theta \sin\phi & -\sin\phi \\ -\sin\phi & \cos\phi & 0 \end{bmatrix} \begin{bmatrix} Q_x \\ 0 \\ Q_z \end{bmatrix};$$

$$Q_r = Q_x \sin\theta \cos\phi + Q_z \cos\theta = \sin^2\theta \cos\phi - r \sin\theta \cos^2\theta \sin\phi.$$

$$Q_\theta = Q_x \cos\theta \cos\phi - Q_z \sin\theta = \sin\theta \cos\theta \cos\phi + r \sin^2\theta \cos\theta \sin\phi.$$

$$Q_\phi = -Q_x \sin\phi = -\sin\theta \sin\phi.$$

$$\therefore \bar{Q} = \sin\theta (\sin\theta \cos\phi - r \cos^2\theta \sin\phi) \bar{a}_r + \sin\theta \cos\theta (\cos\phi + r \sin\theta \sin\phi) \bar{a}_\theta - \sin\theta \sin\phi \bar{a}_\phi.$$

At T :

$$\bar{Q}(x, y, z) = \frac{4}{5} \bar{a}_x + \frac{12}{5} \bar{a}_z = 0.8 \bar{a}_x + 2.4 \bar{a}_z;$$

$$\begin{aligned} \bar{Q}(\rho, \phi, z) &= \frac{4}{5} (\cos 270^\circ \bar{a}_\rho - \sin 270^\circ \bar{a}_\phi - 3 \sin 270^\circ \bar{a}_z) \\ &= 0.8 \bar{a}_\phi + 2.4 \bar{a}_z; \end{aligned}$$

$$\begin{aligned} \bar{Q}(r, \theta, \phi) &= \frac{4}{5} \left(0 - \frac{45}{25} (-1)\right) \bar{a}_r + \frac{4}{5} \left(\frac{3}{5}\right) \left(0 - \frac{20}{5} (-1)\right) \bar{a}_\theta - \frac{4}{5} (-1) \bar{a}_\phi \\ &= \frac{36}{25} \bar{a}_r + \frac{48}{25} \bar{a}_\theta + \frac{4}{5} \bar{a}_\phi = \underline{\underline{1.44 \bar{a}_r + 1.92 \bar{a}_\theta + 0.8 \bar{a}_\phi}}; \end{aligned}$$

Note, that the magnitude of vector $Q = 2.53$ in all 3 cases above.

P.E. 2.2 (a)

$$\begin{bmatrix} A_x \\ A_y \\ A_z \end{bmatrix} = \begin{bmatrix} \cos\phi & -\sin\phi & 0 \\ \sin\phi & \cos\phi & 0 \\ 0 & 0 & 1 \end{bmatrix} \begin{bmatrix} \rho z \sin\phi \\ 3\rho \cos\phi \\ \rho \cos\phi \sin\phi \end{bmatrix}$$

$$\bar{A} = (\rho z \cos\phi \sin\phi - 3\rho \cos\phi \sin\phi) \bar{a}_x + (\rho z \sin^2\phi + 3\rho \cos^2\phi) \bar{a}_y + \rho \cos\phi \sin\phi \bar{a}_z.$$

$$\text{But } \rho = \sqrt{x^2 + y^2}, \quad \tan\phi = \frac{y}{x}, \quad \cos\phi = \frac{x}{\sqrt{x^2 + y^2}}, \quad \sin\phi = \frac{y}{\sqrt{x^2 + y^2}};$$

Substituting all this yields:

$$\bar{A} = \frac{1}{\sqrt{x^2 + y^2}} [(xyz - 3xy) \bar{a}_x + (zy^2 + 3x^2) \bar{a}_y + xy \bar{a}_z].$$

$$\begin{bmatrix} B_x \\ B_y \\ B_z \end{bmatrix} = \begin{bmatrix} \sin\theta \cos\phi & \cos\theta \cos\phi & -\sin\phi \\ \sin\theta \sin\phi & \cos\theta \sin\phi & \cos\phi \\ \cos\theta & -\sin\theta & 0 \end{bmatrix} \begin{bmatrix} r^2 \\ 0 \\ \sin\theta \end{bmatrix}$$

$$\text{Since } r = \sqrt{x^2 + y^2 + z^2}, \quad \tan\theta = \frac{\sqrt{x^2 + y^2}}{z}, \quad \tan\phi = \frac{y}{x};$$

$$\text{and } \sin\theta = \frac{\sqrt{x^2 + y^2}}{\sqrt{x^2 + y^2 + z^2}}, \quad \cos\theta = \frac{z}{\sqrt{x^2 + y^2 + z^2}};$$

$$\text{and } \sin\phi = \frac{y}{\sqrt{x^2 + y^2}}, \quad \cos\phi = \frac{x}{\sqrt{x^2 + y^2}};$$

$$B_x = r^2 \sin\theta \cos\phi - \sin\theta \sin\phi = rx - \frac{y}{r} = \frac{1}{r}(r^2x - y).$$

$$B_y = r^2 \sin\theta \sin\phi + \sin\theta \cos\phi = ry + \frac{y}{x} = \frac{1}{r}(r^2y + x).$$

$$B_z = r^2 \cos\theta = rz = \frac{1}{r}(r^2z).$$

Hence,

$$B = \frac{1}{\sqrt{x^2 + y^2 + z^2}} [\{x(x^2 + y^2 + z^2) - y\} \bar{a}_x + \{y(x^2 + y^2 + z^2) + x\} \bar{a}_y + z(x^2 + y^2 + z^2) \bar{a}_z].$$

P.E.2.3 (a) At:

$$(1, \pi/3, 0), \quad H = (0, 0.5, 1)$$

$$a_x = \cos\phi \bar{a}_\rho - \sin\phi \bar{a}_\phi = \frac{1}{2}(\bar{a}_\rho - \sqrt{3}\bar{a}_\phi)$$

$$\bar{H} \cdot \bar{a}_x = -\frac{\sqrt{3}}{4} = \underline{\underline{-0.433}}$$

(b) At:

$$(1, \pi/3, 0), \quad \bar{a}_\theta = \cos\theta \bar{a}_\rho - \sin\theta \bar{a}_z = -\bar{a}_z.$$

$$\bar{H} \times \bar{a}_\theta = \begin{vmatrix} \bar{a}_\rho & \bar{a}_\phi & \bar{a}_z \\ 0 & \frac{1}{2} & 1 \\ 0 & 0 & -1 \end{vmatrix} = \underline{\underline{-0.5 \bar{a}_\rho}}$$

(c) $(H \cdot \bar{a}_\rho) \bar{a}_\rho = \underline{\underline{0 \bar{a}_\rho}}$.

(d) $\bar{H} \times \bar{a}_z = \begin{vmatrix} \bar{a}_\rho & \bar{a}_\phi & \bar{a}_z \\ 0 & 1/2 & 1 \\ 0 & 0 & 1 \end{vmatrix} = 0.5 \bar{a}_\rho.$

$$|\bar{H} \times \bar{a}_z| = \underline{\underline{0.5}}$$

P.E. 2.4

(a)

$$\bar{A} \cdot \bar{B} = (3, 2, -6) \cdot (4, 0, 3) = \underline{\underline{-6}}$$

(b) $|\bar{A} \times \bar{B}| = \begin{vmatrix} 3 & 2 & -6 \\ 4 & 0 & 3 \end{vmatrix} = |6\bar{a}_r - 33\bar{a}_\theta - 8\bar{a}_\phi|$

Thus the magnitude of $\bar{A} \times \bar{B} = \underline{\underline{34.48}}$.

(c)

At $(1, \pi/3, 5\pi/4), \quad \theta = \pi/3,$

$$\bar{a}_z = \cos\theta \bar{a}_r - \sin\theta \bar{a}_\theta = \frac{1}{2}\bar{a}_r - \frac{\sqrt{3}}{2}\bar{a}_\theta.$$

$$\begin{aligned}
 (\bar{A} \cdot \bar{a}_z) \bar{a}_z &= \left(\frac{3}{2} - \sqrt{3}\right) \left(\frac{1}{2} \bar{a}_r - \frac{\sqrt{3}}{2} \bar{a}_\theta\right) \\
 &= \underline{\underline{-0.116 \bar{a}_r + 0.201 \bar{a}_\theta}}.
 \end{aligned}$$

Prob. 2.1

(a)

$$x = \rho \cos \phi = 1 \cos 60^\circ = 0.5;$$

$$y = \rho \sin \phi = 1 \sin 120^\circ = 0.866;$$

$$z = 2;$$

$$P(x, y, z) = \underline{\underline{P(0.5, 0.866, 2)}}.$$

(b)

$$x = 2 \cos 90^\circ = 0; \quad y = 2 \sin 90^\circ = 2; \quad z = -10.$$

$$Q = \underline{\underline{Q(0, 2, -10)}}.$$

(c)

$$x = r \sin \theta \cos \phi = 3 \sin 45^\circ \cos 210^\circ = -1.837;$$

$$y = r \sin \theta \sin \phi = 10 \sin 135^\circ \sin 90^\circ = -1.061;$$

$$z = r \cos \theta = 10 \cos 135^\circ = 2.121.$$

$$R(x, y, z) = \underline{\underline{R(-1.837, -1.061, 2.121)}}.$$

(d)

$$x = 4 \sin 90^\circ \cos 30^\circ = 3.464.$$

$$y = 3 \sin 30^\circ \sin 240^\circ = 2.$$

$$z = r \cos \theta = 4 \cos 90^\circ = 0.$$

$$T(x, y, z) = \underline{\underline{T(3.464, 2, 0)}}.$$

Prob. 2.2(a) Given $P(1, -4, -3)$, convert to cylindrical and spherical values;

$$\rho = \sqrt{x^2 + y^2} = \sqrt{1^2 + (-4)^2} = \sqrt{17} = 4.123.$$

$$\phi = \tan^{-1} \frac{y}{x} = \tan^{-1} \frac{-4}{1} = 284.04^\circ.$$

$$\therefore P(\rho, \phi, z) = \underline{\underline{(4.123, 284.04^\circ, -3)}}.$$

Spherical:

$$r = \sqrt{x^2 + y^2 + z^2} = \sqrt{1 + 16 + 9} = 5.099.$$

$$\theta = \tan^{-1} \frac{\rho}{z} = \tan^{-1} \frac{4.123}{-3} = 126.04^\circ.$$

$$P(r, \theta, \phi) = \underline{\underline{P(5.099, 126.04^\circ, 284.04^\circ)}}.$$

Prob. 2.3

(a)

$$x = \rho \cos \phi, \quad y = \rho \sin \phi,$$

$$V = \underline{\underline{\rho z \cos \phi - \rho^2 \sin \phi \cos \phi + \rho z \sin \phi}}$$

(b)

$$\begin{aligned} U &= x^2 + y^2 + z^2 + y^2 + 2z^2 \\ &= r^2 + r^2 \sin^2 \theta \sin^2 \phi + 2r^2 \cos^2 \theta \\ &= \underline{\underline{r^2 [1 + \sin^2 \theta \sin^2 \phi + 2 \cos^2 \theta]}} \end{aligned}$$

Prob. 2.4

(a)

$$\begin{bmatrix} D_\rho \\ D_\phi \\ D_z \end{bmatrix} = \begin{bmatrix} \cos \phi & \sin \phi & 0 \\ -\sin \phi & \cos \phi & 0 \\ 0 & 0 & 1 \end{bmatrix} \begin{bmatrix} 0 \\ x+z \\ 0 \end{bmatrix}$$

$$D_\rho = (x+z) \sin \phi = (\rho \cos \phi + z) \sin \phi$$

$$D_\phi = (x+z) \cos \phi = (\rho \cos \phi + z) \cos \phi$$

$$\underline{\underline{\bar{D} = (\rho \cos \phi + z) [\sin \phi \bar{a}_\rho + \cos \phi \bar{a}_\phi]}}$$

Spherical:

$$\begin{bmatrix} D_r \\ D_\theta \\ D_\phi \end{bmatrix} = \begin{bmatrix} \dots & \sin \theta \sin \phi & \dots \\ \dots & \cos \theta \sin \phi & \dots \\ \dots & \cos \phi & \dots \end{bmatrix} \begin{bmatrix} 0 \\ x+z \\ 0 \end{bmatrix}$$

$$D_r = (x+z) \sin\theta \cos\phi = r(\sin\theta \cos\phi + \cos\theta) \sin\theta \sin\phi.$$

$$D_\theta = (x+z) \cos\theta \sin\phi = r(\sin\theta \sin\phi + \cos\theta) \cos\theta \sin\phi.$$

$$D_\phi = (x+z) \cos\phi = r(\sin\theta \cos\phi + \cos\theta) \cos\phi.$$

$$\underline{\underline{D = r(\sin\theta \cos\phi + \cos\theta)[\sin\theta \sin\phi \bar{a}_r + \cos\theta \sin\phi \bar{a}_\theta + \cos\phi \bar{a}_\phi].}}$$

(b) Cylindrical:

$$\begin{bmatrix} E_\rho \\ E_\phi \\ E_z \end{bmatrix} = \begin{bmatrix} \cos\phi & \sin\phi & 0 \\ -\sin\phi & \cos\phi & 0 \\ 0 & 0 & 1 \end{bmatrix} \begin{bmatrix} y^2 - x^2 \\ xyz \\ x^2 - z^2 \end{bmatrix}$$

$$\begin{aligned} E_\rho &= (y^2 - x^2) \cos\phi + xyz \sin\phi \\ &= \rho^2(\sin^2\phi - \cos^2\phi) \cos\phi + \rho^2 z \cos\phi \sin^2\phi \\ &= -\rho^2 \cos 2\phi \cos\phi + \rho^2 z \sin^2\phi \cos\phi. \end{aligned}$$

$$\begin{aligned} E_\phi &= -(y^2 - x^2) \sin\phi + xyz \cos\phi \\ &= \rho^2 \cos 2\phi \sin\phi + \rho^2 z \sin\phi \cos^2\phi. \end{aligned}$$

$$E_z = x^2 - z^2 = \rho^2 \cos^2\phi - z^2.$$

$$\underline{\underline{\bar{E} = \rho^2 \cos\phi(z \sin^2\phi - \cos 2\phi) \bar{a}_\rho + \rho^2 \sin\phi(2 \cos^2\phi + \cos 2\phi) \bar{a}_\phi + (\rho^2 \cos\phi - z^2) \bar{a}_z.}}$$

In spherical:

$$\begin{bmatrix} E_r \\ E_\theta \\ E_\phi \end{bmatrix} = \begin{bmatrix} \sin\theta \cos\phi & \sin\theta \sin\phi & \cos\theta \\ \cos\theta \cos\phi & \cos\theta \sin\phi & -\sin\theta \\ -\sin\phi & \cos\phi & 0 \end{bmatrix} \begin{bmatrix} y^2 - x^2 \\ xyz \\ x^2 - z^2 \end{bmatrix}$$

$$E_r = (y^2 - x^2) \sin\theta \cos\phi + xyz \sin\theta \sin\phi + (x^2 - z^2) \cos\theta;$$

$$\text{but } x = r \sin\theta \cos\phi, \quad y = r \sin\theta \sin\phi, \quad z = r \cos\theta;$$

$$E_r = r^2 \sin^2\theta (\sin^2\phi - \cos^2\phi) \cos\phi + r^3 \sin^3\theta \cos\theta \sin^2\phi \cos\phi + r^2 (\sin^2\theta \cos^2\phi) \cos\theta;$$

$$E_\theta = (y^2 - x^2) \cos\theta \cos\phi + xyz \cos\theta \sin\phi - (x^2 - z^2) \sin\theta;$$

$$= -r^2 \sin^2\theta \cos 2\phi \cos\theta \cos\phi + r^3 \sin^2\theta \cos^2\theta \sin^2\phi \cos\phi - r^2 (\sin^2\theta \cos^2\phi - \cos^2\theta) \sin\theta;$$

$$E_\phi = (x^2 - y^2) \sin\phi + xyz \cos\phi$$

$$= r^2 \sin^2\theta \cos 2\phi \sin\phi + r^3 \sin^2\theta \cos^2\phi \sin\phi \cos\theta;$$

$$\begin{aligned} \bar{E} = & [-r^2 \sin^3 \theta \cos 2\phi + r^3 \sin^3 \theta \cos \theta \sin^2 \phi \cos \phi + r^2 (\sin^2 \theta \cos^2 \phi - \cos^2 \theta) \cos \theta] \bar{a}_r + \\ & [-r^2 \sin^2 \theta \cos 2\phi \cos \theta \cos \phi + r^3 \sin^2 \theta \cos^2 \theta \sin^2 \phi \cos \phi - r^2 \sin \theta (\sin^2 \theta \cos^2 \phi - \cos^2 \theta)] a_\theta + \\ & + \underline{\underline{[r^2 \sin^2 \theta \cos 2\phi \sin \phi + r^3 \sin^2 \theta \cos^2 \phi \sin \phi \cos \theta] \bar{a}_\phi}} \end{aligned}$$

Prob. 2.5 (a)

$$\begin{bmatrix} F_\rho \\ F_\phi \\ F_z \end{bmatrix} = \begin{bmatrix} \cos \phi & \sin \phi & 0 \\ -\sin \phi & \sin \phi & 0 \\ 0 & 0 & 1 \end{bmatrix} \begin{bmatrix} \frac{x}{\sqrt{\rho^2 + z^2}} \\ \frac{y}{\sqrt{\rho^2 + z^2}} \\ \frac{4}{\sqrt{\rho^2 + z^2}} \end{bmatrix}$$

$$F_\rho = \frac{1}{\sqrt{\rho^2 + z^2}} [\rho \cos^2 \phi + \rho \sin^2 \phi] = \frac{\rho}{\sqrt{\rho^2 + z^2}};$$

$$F_\phi = \frac{1}{\sqrt{\rho^2 + z^2}} [-\rho \cos \phi \sin \phi + \rho \cos \phi \sin \phi] = 0;$$

$$F_z = \frac{4}{\sqrt{\rho^2 + z^2}};$$

$$\underline{\underline{\bar{F} = \frac{1}{\sqrt{\rho^2 + z^2}} (\rho \bar{a}_\rho + 4 \bar{a}_z)}}.$$

In Spherical:

$$\begin{bmatrix} F_r \\ F_\theta \\ F_\phi \end{bmatrix} = \begin{bmatrix} \sin \theta \cos \phi & \sin \theta \sin \phi & \cos \theta \\ \cos \theta \cos \phi & \cos \theta \sin \phi & -\sin \theta \\ -\sin \theta & \cos \phi & 0 \end{bmatrix} \begin{bmatrix} \frac{x}{r} \\ \frac{y}{r} \\ \frac{4}{r} \end{bmatrix}$$

$$F_r = \frac{r}{r} \sin^2 \theta \cos^2 \theta + \frac{r}{r} \sin^2 \theta \sin^2 \theta + \frac{f}{r} \cos \theta = \sin^2 \theta + \frac{f}{r} \cos \theta;$$

$$F_\theta = \sin \theta \cos \theta \cos^2 \phi + \sin \theta \cos \theta \sin^2 \phi - \frac{f}{r} \sin \theta = \sin \theta \cos \theta - \frac{f}{r} \sin \theta;$$

$$F_\phi = -\sin \theta \cos \phi \sin \phi + \sin \theta \sin \phi \cos \phi = 0;$$

$$\therefore \underline{\underline{\vec{F} = (\sin^2 \theta + \frac{f}{r} \sin \theta) \bar{a}_r + \sin \theta (\cos \theta - \frac{f}{r}) \bar{a}_\theta}}$$

(b)

$$\begin{bmatrix} G_\rho \\ G_\phi \\ G_z \end{bmatrix} = \begin{bmatrix} \cos \phi & \sin \phi & 0 \\ -\sin \phi & \sin \phi & 0 \\ 0 & 0 & 1 \end{bmatrix} \begin{bmatrix} \frac{x\rho^2}{\sqrt{\rho^2 + z^2}} \\ \frac{y\rho^2}{\sqrt{\rho^2 + z^2}} \\ \frac{z\rho^2}{\sqrt{\rho^2 + z^2}} \end{bmatrix}$$

$$G_\rho = \frac{\rho^2}{\sqrt{\rho^2 + z^2}} [\rho \cos^2 \phi + \rho \sin^2 \phi] = \frac{\rho^3}{\sqrt{\rho^2 + z^2}};$$

$$G_\phi = 0;$$

$$G_z = \frac{z\rho^2}{\sqrt{\rho^2 + z^2}};$$

$$\underline{\underline{\vec{G} = \frac{\rho^2}{\sqrt{\rho^2 + z^2}} (\rho \bar{a}_\rho + z \bar{a}_z)}}.$$

Spherical :

$$\begin{bmatrix} G_r \\ G_\theta \\ G_\phi \end{bmatrix} = \begin{bmatrix} \sin \theta \cos \phi & \sin \theta \sin \phi & \cos \theta \\ \cos \theta \cos \phi & \cos \theta \sin \phi & -\sin \theta \\ -\sin \phi & \cos \phi & 0 \end{bmatrix} \begin{bmatrix} \frac{xr \sin \theta}{r} \\ \frac{y \sin \theta}{r} \\ z \sin \theta \end{bmatrix}$$

$$G_r = r \sin^2 \theta \cos^2 \phi + r \sin^2 \theta \sin^2 \phi + r \cos^2 \theta \sin \theta$$

$$= r \sin^3 \theta + r \cos^2 \theta \sin \theta = r \sin \theta.$$

$$G_\theta = r \sin^2 \theta \cos \theta \cos^2 \phi + r \sin^2 \theta \cos \theta \sin^2 \phi - r \sin^3 \theta \cos \theta$$

$$= r \sin^2 \theta \cos \theta - r \sin^2 \theta \cos \theta = 0.$$

$$G_\phi = -r \sin^2 \theta \sin \phi \cos \phi + r \sin^2 \theta \cos \phi \sin \phi = 0.$$

$$\therefore \bar{G} = \underline{\underline{r \sin \theta \bar{a}_r.}}$$

Prob. 2.6 (a)

$$\begin{bmatrix} A_x \\ A_y \\ A_z \end{bmatrix} = \begin{bmatrix} \cos \phi & -\sin \phi & 0 \\ \sin \phi & \cos \phi & 0 \\ 0 & 0 & 1 \end{bmatrix} \begin{bmatrix} \rho(z^2 + 1) \\ -\rho z \cos \phi \\ 0 \end{bmatrix}$$

$$A_x = \rho(z^2 + 1) \cos \phi + \rho z \sin \phi \cos \phi$$

$$= \sqrt{x^2 + y^2} (z^2 + 1) \frac{x}{\sqrt{x^2 + y^2}} + \sqrt{x^2 + y^2} \left(\frac{xyz}{x^2 + y^2} \right)$$

$$= x(z^2 + 1) + \frac{xyz}{\sqrt{x^2 + y^2}}.$$

$$A_y = \rho(z^2 + 1) \sin \phi - \rho z \cos^2 \phi$$

$$= \sqrt{x^2 + y^2} (z^2 + 1) \frac{y}{\sqrt{x^2 + y^2}} - \frac{x^2 z}{\sqrt{x^2 + y^2}}$$

$$= y(z^2 + 1) - \frac{x^2 z}{\sqrt{x^2 + y^2}};$$

$$A_z = 0;$$

$$\therefore \bar{A} = \underline{\underline{\left[x(z^2 + 1) + \frac{xyz}{\sqrt{x^2 + y^2}} \right] \bar{a}_x + \left[y(z^2 + 1) - \frac{x^2 z}{\sqrt{x^2 + y^2}} \right] \bar{a}_y.}}$$

$$\begin{bmatrix} B_x \\ B_y \\ B_z \end{bmatrix} = \begin{bmatrix} \sin\theta \cos\phi & \cos\theta \cos\phi & -\sin\phi \\ \sin\theta \sin\phi & \cos\theta \sin\phi & \cos\phi \\ \cos\theta & -\sin\theta & 0 \end{bmatrix} \begin{bmatrix} 2x \\ r \cos\theta \cos\theta \\ -r \sin\phi \end{bmatrix}$$

$$\begin{aligned} B_x &= 2x \sin\theta \cos\phi + r \cos^2\theta \cos^2\phi + r \sin^2\phi \\ &= \frac{2x^2 \sqrt{x^2 + y^2}}{\sqrt{x^2 + y^2} \sqrt{x^2 + y^2 + z^2}} + \frac{\sqrt{x^2 + y^2 + z^2}}{x^2 + y^2 + z^2} \left(\frac{xz}{x^2 + y^2} \right) + \sqrt{x^2 + y^2 + z^2} \left(\frac{y^2}{x^2 + y^2} \right) \\ &= \frac{2x^2}{\sqrt{x^2 + y^2 + z^2}} + \frac{xz}{(x^2 + y^2)\sqrt{x^2 + y^2 + z^2}} + \frac{y^2 \sqrt{x^2 + y^2 + z^2}}{x^2 + y^2}; \end{aligned}$$

$$\begin{aligned} B_y &= 2x \sin\theta \sin\phi + r \cos^2\theta \sin\phi \cos\phi - r \sin\phi \cos\phi \\ &= \frac{2xy \sqrt{x^2 + y^2}}{\sqrt{x^2 + y^2} \sqrt{x^2 + y^2 + z^2}} + \frac{\sqrt{x^2 + y^2 + z^2} (xyz^2)}{x^2 + y^2 + z^2} - \sqrt{x^2 + y^2 + z^2} \left(\frac{xy}{x^2 + y^2} \right) \\ &= \frac{2xy}{\sqrt{x^2 + y^2 + z^2}} + \frac{xyz^2}{x^2 + y^2 \sqrt{x^2 + y^2 + z^2}} - \frac{xy \sqrt{x^2 + y^2 + z^2}}{\sqrt{x^2 + y^2}}; \end{aligned}$$

$$\begin{aligned} B_z &= 2x \cos\theta - r \sin\theta \cos\theta \cos\phi \\ &= \frac{2xz}{\sqrt{x^2 + y^2 + z^2}} - \frac{\sqrt{x^2 + y^2 + z^2} (xy) \sqrt{x^2 + y^2}}{(x^2 + y^2 + z^2) \sqrt{x^2 + y^2}} \\ &= \frac{2xz}{\sqrt{x^2 + y^2 + z^2}} - \frac{xz}{\sqrt{x^2 + y^2 + z^2}} = \frac{xz}{\sqrt{x^2 + y^2 + z^2}}; \end{aligned}$$

$$\begin{aligned} \therefore \bar{B} &= \left[\frac{2x^2}{\sqrt{x^2 + y^2 + z^2}} + \frac{xz}{(x^2 + y^2)\sqrt{x^2 + y^2 + z^2}} + \frac{y^2 \sqrt{x^2 + y^2 + z^2}}{x^2 + y^2} \right] \bar{a}_x + \\ &\quad \left[\frac{2xy}{\sqrt{x^2 + y^2 + z^2}} + \frac{xyz^2}{(x^2 + y^2)\sqrt{x^2 + y^2 + z^2}} - \frac{xy \sqrt{x^2 + y^2 + z^2}}{x^2 + y^2} \right] \bar{a}_y + \\ &\quad \left[\frac{xz}{\sqrt{x^2 + y^2 + z^2}} \right] \bar{a}_z \end{aligned}$$

Prob 2.7 (a)

$$\begin{bmatrix} C_x \\ C_y \\ C_z \end{bmatrix} = \begin{bmatrix} \cos \phi & -\sin \phi & 0 \\ \sin \phi & \cos \phi & 0 \\ 0 & 0 & 1 \end{bmatrix} \begin{bmatrix} z \sin \phi \\ -\rho \cos \phi \\ 2\rho z \end{bmatrix}$$

$$C_x = z \sin \phi \cos \phi + \rho \sin \phi \cos \phi = \frac{xyz}{x^2 + y^2} + \frac{xy\sqrt{x^2 + y^2}}{x^2 + y^2};$$

$$C_y = z \sin^2 \phi - \rho \cos^2 \phi = \frac{y^2 z}{x^2 + y^2} - \frac{x^2 \sqrt{x^2 + y^2}}{x^2 + y^2};$$

$$C_z = 2\rho z = 2z\sqrt{x^2 + y^2};$$

$$\therefore \underline{\underline{\bar{C} = \left(\frac{xyz}{x^2 + y^2} + \frac{xy}{\sqrt{x^2 + y^2}} \right) \bar{a}_x + \left(\frac{y^2 z}{x^2 + y^2} - \frac{x^2}{\sqrt{x^2 + y^2}} \right) \bar{a}_y + 2z\sqrt{x^2 + y^2} \bar{a}_z}}$$

(b)

$$\begin{bmatrix} D_x \\ D_y \\ D_z \end{bmatrix} = \begin{bmatrix} \sin \theta \cos \phi & \cos \theta \cos \phi & -\sin \phi \\ \sin \theta \sin \phi & \cos \theta \sin \phi & \cos \phi \\ \cos \theta & -\sin \theta & 0 \end{bmatrix} \begin{bmatrix} \frac{\sin \theta}{r^2} \\ \frac{\cos \theta}{r^2} \\ 0 \end{bmatrix}$$

$$D_x = \frac{\sin^2 \theta \cos \phi}{r^2} + \frac{\cos^2 \theta \cos \phi}{r^2} = \frac{\cos \phi}{r^2} = \frac{x}{\sqrt{x^2 + y^2} (x^2 + y^2 + z^2)};$$

$$D_y = \frac{\sin^2 \theta \sin \phi}{r^2} + \frac{\cos^2 \theta \sin \phi}{r^2} = \frac{\sin \phi}{r^2} = \frac{y}{\sqrt{x^2 + y^2} (x^2 + y^2 + z^2)};$$

$$D_z = \frac{\sin \theta \cos \theta}{r^2} - \frac{\sin \theta \cos \theta}{r^2} = 0;$$

$$\therefore \underline{\underline{D = \frac{1}{\sqrt{x^2 + y^2} (x^2 + y^2 + z^2)} (x \bar{a}_x + y \bar{a}_y)}}$$

Prob. 2.8 (a)

$$\bar{a}_x \cdot \bar{a}_\rho = (\cos\phi \bar{a}_\rho - \sin\phi \bar{a}_\phi) \cdot \bar{a}_\rho = \cos\phi$$

$$\bar{a}_x \cdot \bar{a}_\phi = (\cos\phi \bar{a}_\rho - \sin\phi \bar{a}_\phi) \cdot \bar{a}_\phi = -\sin\phi$$

$$\bar{a}_y \cdot \bar{a}_\rho = (\sin\phi \bar{a}_\rho + \cos\phi \bar{a}_\phi) \cdot \bar{a}_\rho = \sin\phi$$

$$\bar{a}_y \cdot \bar{a}_\phi = (\sin\phi \bar{a}_\rho + \cos\phi \bar{a}_\phi) \cdot \bar{a}_\phi = \cos\phi$$

(b)

Since \bar{a}_ρ , \bar{a}_ϕ , and \bar{a}_z are mutually orthogonal

$$\bar{a}_z \cdot \bar{a}_z = 1; \quad \bar{a}_z \cdot \bar{a}_\rho = 0; \quad \bar{a}_z \cdot \bar{a}_\phi = 0.$$

Also, $\bar{a}_x \cdot \bar{a}_z = 0; \quad \bar{a}_y \cdot \bar{a}_z = 0.$

$$\begin{bmatrix} \cos\phi & -\sin\phi & 0 \\ \sin\phi & \cos\phi & 0 \\ 0 & 0 & 1 \end{bmatrix} = \begin{bmatrix} \bar{a}_x \cdot \bar{a}_\rho & \bar{a}_x \cdot \bar{a}_\phi & \bar{a}_x \cdot \bar{a}_z \\ \bar{a}_y \cdot \bar{a}_\rho & \bar{a}_y \cdot \bar{a}_\phi & \bar{a}_y \cdot \bar{a}_z \\ \bar{a}_z \cdot \bar{a}_\rho & \bar{a}_z \cdot \bar{a}_\phi & \bar{a}_z \cdot \bar{a}_z \end{bmatrix}$$

(c)

In spherical system:

$$\bar{a}_x = \sin\theta \cos\phi \bar{a}_r + \cos\theta \cos\phi \bar{a}_\theta - \sin\phi \bar{a}_\phi.$$

$$\bar{a}_y = \sin\theta \sin\phi \bar{a}_r + \cos\theta \sin\phi \bar{a}_\theta - \cos\phi \bar{a}_\phi.$$

$$\bar{a}_z = \cos\theta \bar{a}_r - \sin\theta \bar{a}_\theta.$$

Hence,

$$\bar{a}_x \cdot \bar{a}_r = \sin\theta \cos\phi;$$

$$\bar{a}_x \cdot \bar{a}_\theta = \cos\theta \cos\phi;$$

$$\bar{a}_y \cdot \bar{a}_r = \sin\theta \sin\phi;$$

$$\bar{a}_y \cdot \bar{a}_\theta = \cos\theta \sin\phi;$$

$$\bar{a}_z \cdot \bar{a}_r = \cos\theta;$$

$$\bar{a}_z \cdot \bar{a}_\theta = -\sin\theta;$$

Prob 2.9 (a)

$$r = \sqrt{x^2 + y^2 + z^2} = \sqrt{\rho^2 + z^2}.$$

$$\theta = \tan^{-1} \frac{\rho}{z}; \quad \phi = \phi.$$

or

$$\begin{aligned} \rho &= \sqrt{x^2 + y^2} = \sqrt{r^2 \sin^2 \theta \cos^2 \phi + r^2 \sin^2 \theta \sin^2 \phi} \\ &= r \sin \theta; \end{aligned}$$

$$z = r \cos \theta; \quad \phi = \phi.$$

(a) From the figures below,

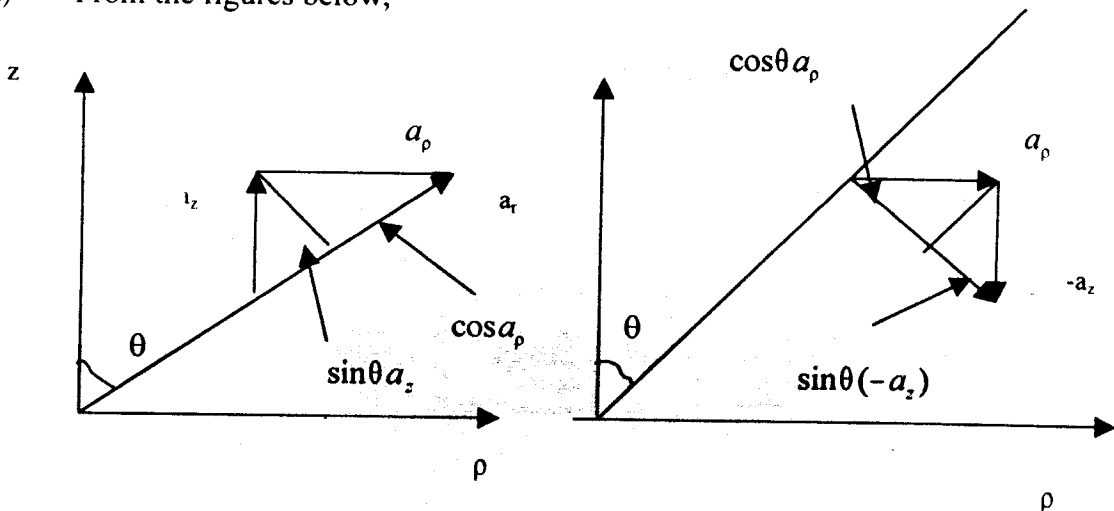

$$\vec{a}_r = \sin \theta \vec{a}_z + \cos \theta \vec{a}_\rho; \quad \vec{a}_\theta = \cos \theta \vec{a}_\rho - \sin \theta \vec{a}_z; \quad \vec{a}_\phi = \vec{a}_\phi.$$

Hence,

$$\begin{bmatrix} \vec{a}_r \\ \vec{a}_\theta \\ \vec{a}_\phi \end{bmatrix} = \begin{bmatrix} \sin \theta & 0 & \cos \theta \\ \cos \theta & 0 & -\sin \theta \\ 0 & 1 & 0 \end{bmatrix} \begin{bmatrix} \vec{a}_\rho \\ \vec{a}_\phi \\ \vec{a}_z \end{bmatrix}$$

From the figures below,

$$\vec{a}_\rho = \cos \theta \vec{a}_\theta + \sin \theta \vec{a}_z; \quad \vec{a}_z = \cos \theta \vec{a}_r - \sin \theta \vec{a}_\theta; \quad \vec{a}_\phi = \vec{a}_\phi.$$

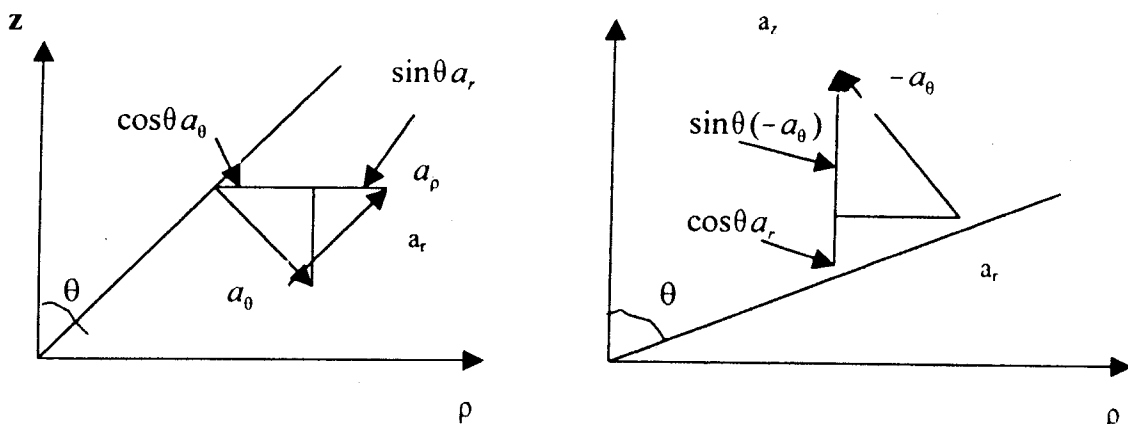

$$\begin{bmatrix} \bar{a}_\rho \\ \bar{a}_\phi \\ \bar{a}_z \end{bmatrix} = \begin{bmatrix} \sin\theta & \cos\theta & 0 \\ 0 & 0 & 1 \\ \cos\theta & -\sin\theta & 0 \end{bmatrix} \begin{bmatrix} \bar{a}_r \\ \bar{a}_\theta \\ \bar{a}_z \end{bmatrix}$$

Prob. 2.10 (a)

$$\begin{bmatrix} H_\rho \\ H_\phi \\ H_z \end{bmatrix} = \begin{bmatrix} \cos\phi & \sin\phi & 0 \\ -\sin\phi & \cos\phi & 0 \\ 0 & 0 & 1 \end{bmatrix} \begin{bmatrix} xy^2z \\ x^2yz \\ xyz^2 \end{bmatrix}$$

$$H_\rho = xy^2z \cos\phi + x^2yz \sin\phi = \rho^3 z \cos^2\phi \sin^2\phi + \rho^3 z \cos^2\phi \sin^2\phi.$$

$$= \frac{1}{2} \rho^3 z \sin^2 2\phi.$$

$$H_\phi = -xy^2z \sin\phi + x^2yz \cos\phi = -\rho^3 z \cos\phi \sin^3\phi + \rho^3 z \cos\phi \sin\phi$$

$$= \rho^3 z \cos\phi \sin\phi \cos 2\phi.$$

$$H_z = xyz^2 = \rho^2 z^2 \sin\phi \cos\phi.$$

$$\bar{H} = \frac{1}{2} \rho^3 z \sin^2 2\phi \bar{a}_\rho + \frac{1}{2} \rho^3 z \sin 2\phi \cos 2\phi \bar{a}_\phi + \frac{1}{2} \rho^3 z \sin 2\phi \bar{a}_z.$$

$$\begin{bmatrix} H_r \\ H_\theta \\ H_\phi \end{bmatrix} = \begin{bmatrix} \sin\theta \cos\phi & \sin\theta \sin\phi & \cos\theta \\ \cos\theta \cos\phi & \cos\theta \sin\phi & -\sin\theta \\ -\sin\phi & \cos\phi & 0 \end{bmatrix} \begin{bmatrix} xy^2z \\ x^2yz \\ xyz^2 \end{bmatrix}$$

$$x = r \sin\theta \cos\phi, \quad y = r \sin\theta \sin\phi, \quad z = r \cos\theta.$$

$$H_r = xyz[y \sin \theta \cos \phi + x \sin \theta \sin \phi + z \cos \theta]$$

$$= r^3 \sin^2 \theta \cos \theta \sin \phi [r \sin^2 \theta \sin \phi \cos \phi + r \sin^2 \theta \sin \phi \cos \phi + r \cos^2 \theta]$$

$$H_\theta = xyz[y \cos \theta \cos \phi + x \cos \theta \sin \phi - z \sin \theta]$$

$$= r^3 \sin^2 \theta \cos \theta \sin \phi \cos \phi [r \sin \theta \cos \theta \sin \phi \cos \phi + r \sin \theta \cos \theta \sin \phi \cos \phi - r \cos \theta \sin \theta]$$

$$H_\phi = xyz[-y \sin \phi + x \cos \phi]$$

$$= r^3 \sin^2 \theta \cos \theta \sin \phi \cos \phi [-r \sin \theta \sin^2 \phi + r \sin \theta \cos^2 \phi]$$

$$= r^4 \sin^3 \theta \cos \theta \sin \phi \cos 2\phi.$$

$$\bar{H} = r^4 \sin^2 \theta \cos \theta \sin \phi \cos \phi [(\sin^2 \theta \sin 2\phi + \cos^2 \theta) \bar{a}_r + \underline{(\sin \theta \cos \theta \sin 2\phi - \cos \theta \sin \theta) \bar{a}_\theta + \sin \theta \cos 2\phi \bar{a}_\phi}].$$

(b)

$$\text{At } (3-45), \bar{H}(x, y, z) = -60(-4, 3, 5)$$

$$\left| \bar{H}(x, y, z) \right| = 424.3$$

This will help check $H(\rho, \phi, z)$ and $H(r, \theta, \phi)$

$$\rho = 5, z = 5, \phi = 360^\circ - \tan^{-1} \frac{4}{3} = 306.87^\circ$$

$$\begin{aligned} \bar{H} &= \frac{1}{2}(125)(5)(-0.96) \bar{a}_\rho + \frac{1}{2}(125)(5)(-0.90)(-0.277) \bar{a}_\phi + \frac{1}{2}(25)(5)(-0.96) \bar{a}_z \\ &= \underline{288 \bar{a}_\rho + 84 \bar{a}_\phi - 300 \bar{a}_z} \end{aligned}$$

Spherical,

$$r = \sqrt{50} = 5\sqrt{2}; \quad \sin \theta = \frac{5}{5\sqrt{2}} = \frac{1}{\sqrt{2}}; \quad \cos \theta = \frac{5}{5\sqrt{2}} = \frac{1}{\sqrt{2}}$$

$$\& \quad \sin \phi = -\frac{4}{5}, \quad \cos \phi = \frac{3}{5}$$

$$\begin{aligned} \therefore \bar{H} &= 2500 \left(\frac{1}{2} \right) \left(\frac{1}{\sqrt{2}} \right) \left(-\frac{12}{25} \right) \left[\left\{ \frac{1}{2} * 2 \left(-\frac{12}{28} \right) + \frac{1}{2} \right\} \bar{a}_r + \left\{ \frac{1}{2} * 2 \left(-\frac{12}{25} \right) - \frac{1}{2} \right\} \bar{a}_\theta + \frac{1}{\sqrt{2}} \left\{ \frac{9}{12} - \frac{16}{25} \right\} \bar{a}_\phi \right] \\ &= \underline{-8.485 \bar{a}_r + 415.8 \bar{a}_\theta + 84 \bar{a}_\phi} \end{aligned}$$

Prob 2.11 (a)

$$\begin{bmatrix} A_x \\ A_y \\ A_z \end{bmatrix} = \begin{bmatrix} \cos \phi & -\sin \phi & 0 \\ \sin \phi & \cos \phi & 0 \\ 0 & 0 & 1 \end{bmatrix} \begin{bmatrix} \rho \cos \phi \\ 0 \\ \rho z^{-2} \sin \phi \end{bmatrix}$$

$$A_x = \rho \cos^2 \phi = \sqrt{x^2 + y^2} \frac{x^2}{x^2 + y^2} = \frac{x^2}{\sqrt{x^2 + y^2}}$$

$$A_y = \rho \sin \phi \cos \phi = \sqrt{x^2 + y^2} \frac{xy}{x^2 + y^2} = \frac{xy}{\sqrt{x^2 + y^2}}$$

$$\underline{\underline{A_z = \frac{l}{\sqrt{x^2 + y^2}} [x^2 \bar{a}_x + xy \bar{a}_y + yz \bar{a}_z].}}$$

At (3, -4, 0) $x=3, y=-4, z=0;$

$$\bar{A} = \frac{1}{5} [9\bar{a}_x - 12\bar{a}_y].$$

$$\underline{\underline{|\bar{A}| = 3}}$$

$$(b) \begin{bmatrix} A_r \\ A_\theta \\ A_\phi \end{bmatrix} = \begin{bmatrix} \sin \theta \cos \phi & \sin \theta \sin \phi & \cos \theta \\ \cos \phi \cos \phi & \cos \theta \sin \phi & -\sin \theta \\ -\sin \phi & \cos \phi & 0 \end{bmatrix} \begin{bmatrix} \frac{x^2}{\rho} \\ \frac{xy}{\rho} \\ \frac{yz^2}{\rho} \end{bmatrix}$$

$$x = r \sin \theta \cos \phi, \quad y = r \sin \theta \sin \phi, \quad z = r \cos \theta, \quad \rho = r \sin \theta.$$

$$A_r = \frac{r^2 \sin^2 \theta \cos^2 \phi}{r \sin \theta} \sin \theta \cos \phi + \frac{r^2 \sin^2 \theta \cos \phi \sin \phi}{r \sin \theta} \sin \theta \sin \phi + \frac{r^3 \sin \theta \cos^2 \phi}{r \sin \theta} \sin \phi \cos \theta$$

$$= r \sin^2 \theta \cos \phi + r^2 \cos^3 \theta \sin \theta$$

$$A_\theta = r \sin \theta \cos^2 \phi \cos \theta \cos \phi + r \sin \theta \cos \phi \sin \phi \cos \theta \sin \phi - r^2 \cos^2 \theta \sin \phi \sin \theta$$

$$= r \sin \theta \cos \theta \cos \phi - r^2 \sin \theta \cos^2 \sin \phi$$

$$= r \sin \theta \cos \theta [\cos \phi - r \cos \theta \sin \phi]$$

$$A_\phi = -r \sin \theta \cos^2 \phi \sin \phi + r \sin \theta \cos \phi \sin \phi \cos \phi = 0.$$

\therefore

$$\underline{\underline{\bar{A} = r [\sin^2 \theta \cos \phi + r \cos^3 \theta \sin \theta] \bar{a}_r + r \sin \theta \cos \theta [\cos \phi - r \cos \theta \sin \phi] \bar{a}_\theta.}}$$

$$At (3-4,0), r=5, \theta = \pi/2, \phi = 306.83$$

$$\cos\phi = 3/5, \quad \sin\phi = -4/5.$$

$$\bar{A} = 5\left[1^2 \cdot \frac{3}{5} + 5(0)(-4/5)\right]\bar{a}_r + 5(1)(0)a_\theta$$

$$= 3\bar{a}_r.$$

$$\underline{\underline{|\bar{A}| = 3.}}$$

Prob 2.12

$$\begin{bmatrix} A_x \\ A_y \\ A_z \end{bmatrix} = \begin{bmatrix} \cos\phi & -\sin\phi & 0 \\ \sin\phi & \cos\phi & 0 \\ 0 & 0 & 1 \end{bmatrix} \begin{bmatrix} A_\rho \\ A_\phi \\ A_z \end{bmatrix}$$

$$= \begin{bmatrix} \frac{x}{\sqrt{x^2+y^2}} & -\frac{y}{\sqrt{x^2+y^2}} & 0 \\ \frac{y}{\sqrt{x^2+y^2}} & \frac{x}{\sqrt{x^2+y^2}} & 0 \\ 0 & 0 & 1 \end{bmatrix} \begin{bmatrix} A_\rho \\ A_\phi \\ A_z \end{bmatrix}$$

$$\begin{bmatrix} A_x \\ A_y \\ A_z \end{bmatrix} = \begin{bmatrix} \sin\theta\cos\phi & \cos\theta\cos\phi & -\sin\phi \\ \sin\theta\sin\phi & \cos\theta\sin\phi & \cos\phi \\ \cos\theta & -\sin\theta & 0 \end{bmatrix} \begin{bmatrix} A_r \\ A_\theta \\ A_\phi \end{bmatrix}$$

$$= \begin{bmatrix} \frac{x}{\sqrt{x^2+y^2+z^2}} & \frac{xz}{\sqrt{x^2+y^2}\sqrt{x^2+y^2+z^2}} & \frac{-y}{\sqrt{x^2+y^2}} \\ \frac{y}{\sqrt{x^2+y^2+z^2}} & \frac{yz}{\sqrt{x^2+y^2}\sqrt{x^2+y^2+z^2}} & \frac{x}{\sqrt{x^2+y^2}} \\ \frac{z}{\sqrt{x^2+y^2+z^2}} & -\frac{\sqrt{x^2+y^2}}{\sqrt{x^2+y^2+z^2}} & 0 \end{bmatrix} \begin{bmatrix} A_r \\ A_\theta \\ A_\phi \end{bmatrix}$$

Prob 2.13 (a) Using the results in Prob.2.9,

$$A_\rho = \rho z \sin \phi = r^2 \sin \theta \cos \theta \sin \phi$$

$$A_\phi = 3\rho \cos \phi = 3r \sin \theta \cos \phi$$

$$A_z = \rho \cos \phi \sin \phi = r \sin \theta \cos \phi \sin \phi$$

Hence,

$$\begin{bmatrix} A_r \\ A_\theta \\ A_\phi \end{bmatrix} = \begin{bmatrix} \sin \theta & 0 & \cos \theta \\ \cos \theta & 0 & -\sin \theta \\ 0 & 1 & 0 \end{bmatrix} \begin{bmatrix} r^2 \sin \theta \cos \theta \sin \phi \\ 3r \sin \theta \cos \phi \\ r \sin \theta \cos \phi \sin \phi \end{bmatrix}$$

$$A(r, \theta, \phi) = r \sin \theta \left[\sin \phi \cos \theta (r \sin \theta + \cos \phi) a_r + \sin \phi (r \cos^2 \theta - \sin \theta \cos \phi) a_\theta + 3 \cos \phi a_\phi \right]$$

At $(10, \pi/2, 3\pi/4)$, $r = 10, \theta = \pi/2, \phi = 3\pi/4$

$$\bar{A} = 10(0a_r + 0.5a_\theta - \frac{3}{\sqrt{2}}a_\phi) = \underline{\underline{5a_\theta - 21.21a_\phi}}$$

(b) $B_r = r^2 = (\rho^2 + z^2)$, $B_\theta = 0$, $B_\phi = \sin \theta = \frac{\rho}{\sqrt{\rho^2 + z^2}}$

$$\begin{bmatrix} B_\rho \\ B_\phi \\ B_z \end{bmatrix} = \begin{bmatrix} \sin \theta & \cos \theta & 0 \\ 0 & 0 & 1 \\ \cos \theta & -\sin \theta & 0 \end{bmatrix} \begin{bmatrix} B_r \\ B_\theta \\ B_\phi \end{bmatrix}$$

$$B(\rho, \phi, z) = \sqrt{\rho^2 + z^2} \left(\rho a_\rho + \frac{\rho}{\rho^2 + z^2} a_\phi + z a_z \right)$$

At $(2, \pi/6, 1)$, $\rho = 2, \phi = \pi/6, z = 1$

$$B = \sqrt{5}(2a_\rho + 0.4a_\phi + a_z) = \underline{\underline{4.472a_\rho + 0.8944a_\phi + 2.236a_z}}$$

Prob 2.14

(a) $d = \sqrt{(6-2)^2 + (-1-1)^2 + (2-5)^2} = \sqrt{29} = \underline{\underline{5.385}}$

$$d^2 = 3^2 + 5^2 - 2(3)(5)\cos \pi + (-1-5)^2 = 100$$

(b) $d = \sqrt{100} = \underline{\underline{10}}$

(c)

$$d^2 = 10^2 + 5^2 - 2(10)(5)\cos\frac{\pi}{4}\cos\frac{\pi}{6}$$

$$d^2 = (10)(5)\sin\frac{\pi}{4}\sin\frac{\pi}{6}\cos 7\frac{\pi}{4} - \frac{3\pi}{4}$$

$$d = \sqrt{99.12} = \underline{\underline{9.956}}$$

Prob 2.15

- (a) An infinite line parallel to the z-axis.
- (b) Point (2,-1,10).
- (c) A circle of radius $r \sin\theta = 5$, i.e. the intersection of a cone and a sphere.
- (d) An infinite line parallel to the z-axis.
- (e) A semi-infinite line parallel to the x-y plane.
- (f) A semi-circle of radius 5 in the x-y plane.

Prob.2.16At $T(2,3,-4)$

$$\theta = \tan^{-1} \frac{\sqrt{x^2 + y^2}}{z} = \tan^{-1} \frac{\sqrt{13}}{-4} = 137.97$$

$$\cos\theta = \frac{-4}{\sqrt{29}} = -0.7428, \sin\theta = \frac{\sqrt{13}}{\sqrt{29}} = 0.6695$$

$$\phi = \tan^{-1} \frac{y}{x} = \tan^{-1} \frac{3}{2} = 56.31$$

$$\cos\phi = \frac{2}{\sqrt{13}}, \sin\phi = \frac{3}{\sqrt{13}}$$

$$\bar{a}_z = \cos\theta \bar{a}_r - \sin\theta \bar{a}_\theta = \underline{\underline{-0.7428\bar{a}_r - 0.6695\bar{a}_\theta}}$$

$$\bar{a}_r = \sin\theta \cos\phi \bar{a}_x + \sin\theta \sin\phi \bar{a}_y + \cos\theta \bar{a}_z$$

$$= \underline{\underline{0.3714\bar{a}_x + 0.5571\bar{a}_y - 0.7428\bar{a}_z}}$$

Prob.2.17

At $P(0,2,-5)$, $\phi = 90^\circ$;

$$\begin{aligned} \begin{bmatrix} B_x \\ B_y \\ B_z \end{bmatrix} &= \begin{bmatrix} \cos\phi & -\sin\phi & 0 \\ \sin\phi & \cos\phi & 0 \\ 0 & 0 & 1 \end{bmatrix} \begin{bmatrix} B_p \\ B_\phi \\ B_z \end{bmatrix} \\ &= \begin{bmatrix} 0 & -1 & 0 \\ 1 & 0 & 0 \\ 0 & 0 & 1 \end{bmatrix} \begin{bmatrix} -5 \\ 1 \\ -3 \end{bmatrix} \end{aligned}$$

$$\bar{B} = -\bar{a}_x - 5\bar{a}_y - 3\bar{a}_z$$

(a) $\bar{A} + \bar{B} = (2,4,10) + (-1,-5,-3)$

$$= \underline{\underline{\bar{a}_x - \bar{a}_y + 7\bar{a}_z}}$$

(b) $\cos\theta_{AB} = \frac{\bar{A} \cdot \bar{B}}{\|\bar{A}\| \|\bar{B}\|} = \frac{-52}{\sqrt{4200}}$

$$\theta_{AB} = \cos^{-1}\left(\frac{-52}{\sqrt{4200}}\right) = \underline{\underline{143.26^\circ}}$$

(c) $A_B = \bar{A} \cdot \bar{a}_B = \frac{\bar{A} \cdot \bar{B}}{B} = -\frac{52}{\sqrt{35}} = \underline{\underline{-8.789}}$

Prob. 2.18

At $P(8, 30^\circ, 60^\circ)$, $P(r, \theta, \phi)$,

$$x = r \sin\theta \cos\phi = 8 \sin 30^\circ \cos 60^\circ = 2.$$

$$y = r \sin\theta \sin\phi = 8 \sin 30^\circ \sin 60^\circ = 2\sqrt{3}$$

$$z = r \cos\theta = 8\left(\frac{1}{2}\sqrt{3}\right) = 4\sqrt{3}.$$

$$\bar{G} = 14\bar{a}_x + 8\sqrt{3}\bar{a}_y + (48 + 24)\bar{a}_z = (14, 13.86, 72);$$

$$\bar{a}_\phi = -\sin\phi \bar{a}_x + \cos\phi \bar{a}_y = -\frac{\sqrt{3}}{2}\bar{a}_x + \frac{1}{2}\bar{a}_y;$$

$$G_\phi = (\bar{G} \cdot \bar{a}_\phi) \bar{a}_\phi = (-7\sqrt{3} + 4\sqrt{3})\frac{1}{2}(-\sqrt{3}\bar{a}_x + \bar{a}_y)$$

$$= \underline{\underline{4.5\bar{a}_x - 2.598\bar{a}_y}}$$

Prob. 2.19

$$(a) \quad J_z = (J \cdot \bar{a}_z) \bar{a}_z.$$

$$\text{At } (2, \pi/2, 3\pi/2), \quad \bar{a}_z = \cos\theta \bar{a}_r - \sin\theta \bar{a}_\theta = -\bar{a}_\theta.$$

$$J_z = -\cos 2\theta \sin\phi \bar{a}_\theta = -\cos\pi \sin(3\pi/2) \bar{a}_\theta = -\bar{a}_\theta.$$

$$(b) \quad \bar{J}_\theta = \tan\frac{\theta}{2} \ln r \bar{a}_\theta = \tan\frac{\pi}{4} \ln 2 \bar{a}_\theta = \ln 2 \bar{a}_\theta = 0.6931 \bar{a}_\theta.$$

$$(c) \quad \bar{J}_t = \bar{J} - \bar{J}_n = \bar{J} - \bar{J}_r = -\bar{a}_\theta + \ln 2 \bar{a}_\theta = \underline{\underline{-\bar{a}_\theta + 0.6931 \bar{a}_\theta}}.$$

$$(d) \quad \bar{J}_r = (J \cdot \bar{a}_x) \bar{a}_x$$

$$\bar{a}_x = \sin\theta \cos\phi \bar{a}_r + \cos\theta \cos\phi \bar{a}_\theta - \sin\phi \bar{a}_\phi = \bar{a}_\phi.$$

$$\text{At } (2, \pi/2, 3\pi/2),$$

$$\bar{J}_r = \underline{\underline{\ln 2 \bar{a}_\phi}}.$$

Prob 2.20

$$\text{At } P, \quad \rho = 2, \quad \phi = 30^\circ, \quad z = -1$$

$$\bar{H} = 10 \sin 30^\circ \bar{a}_\rho + 2 \cos 30^\circ \bar{a}_\phi - 4 \bar{a}_z.$$

$$= 5 \bar{a}_\rho + 1.732 \bar{a}_\phi - 4 \bar{a}_z.$$

$$\bar{a}_n = \frac{(5, 1.732, -4)}{\sqrt{5^2 + 1.732^2 + 4^2}} = \underline{\underline{0.7538 \bar{a}_\rho + 0.2611 \bar{a}_\phi - 0.603 \bar{a}_z}}.$$

$$(b) \quad H_x = H_\rho \cos\phi - H_\phi \sin\phi = 5\rho \sin\phi \cos\phi - \rho z \cos\phi \sin\phi$$

or P at $\rho = 5, \phi = 30^\circ, z = 1;$

$$\bar{H}_x = H_x \bar{a}_x = (25 \sin 30^\circ \cos 30^\circ + 5 \sin 30^\circ \cos 30^\circ) \bar{a}_x.$$

$$= \underline{\underline{13 \bar{a}_x}}$$

$$(c) \quad \text{Normal to } \rho = 2 \text{ is } \bar{H}_n = \bar{H}_\rho \bar{a}_\rho;$$

$$\text{i.e. } \bar{H}_n = \underline{\underline{0.7538 \bar{a}_\rho}}.$$

$$(d) \quad \text{Tangential to } \phi = 30^\circ.$$

$$H_t = H_\rho a_\phi + H_z a_z = \underline{\underline{0.7538 a_\phi - 0.603 a_z}}$$

Prob.2.21

$$(a) \text{ At } T, x = 3, y = -4, z = 1, \rho = 5, \cos\phi = -\frac{3}{5}$$

$$\bar{A} = 0\bar{a}_\rho - 5(1)\left(-\frac{3}{5}\right)\bar{a}_\phi + 25(1)\bar{a}_z$$

$$= \underline{3\bar{a}_\phi + 25\bar{a}_z}$$

$$r = \sqrt{26}, \quad \sin\theta = \frac{5}{\sqrt{26}}, \quad \cos\theta = \frac{1}{\sqrt{26}}$$

$$\bar{B} = 26\left(\frac{-3}{5}\right)\bar{a}_r + 2(\sqrt{26})\frac{5}{\sqrt{26}}\bar{a}_\phi$$

$$= \underline{-15.6\bar{a}_r + 10\bar{a}_\phi}$$

(b) In cylindrical coordinates,

$$\begin{bmatrix} B_\rho \\ B_\phi \\ B_z \end{bmatrix} = \begin{bmatrix} \sin\theta & \cos\theta & 0 \\ 0 & 0 & 1 \\ \cos\theta & -\sin\theta & 0 \end{bmatrix} \begin{bmatrix} -15.6 \\ 0 \\ 10 \end{bmatrix}$$

$$B_\rho = 15.6 \sin\theta = 26\left(-\frac{3}{5}\right)\left(\frac{5}{\sqrt{26}}\right) = 15.3$$

$$B_\phi = 10, \quad B_z = 15.6 \cos\theta = -3.059$$

$$\bar{B}(\rho, \phi, z) = (-15.3, 10, -3.059)$$

$$\bar{A}_B = (\bar{A} \cdot \bar{a}_B)\bar{a}_B = (\bar{A} \cdot \bar{B})\frac{\bar{B}}{|\bar{B}|^2} = \frac{(30 - 76.485)(-15.3, 10, -3.059)}{343.36}$$

$$= \underline{2.071\bar{a}_\rho - 1.354\bar{a}_\phi + 0.4141\bar{a}_z}$$

(c) In spherical coordinates,

$$\begin{bmatrix} A_r \\ A_\theta \\ A_\phi \end{bmatrix} = \begin{bmatrix} \sin\theta & 0 & \cos\theta \\ \cos\theta & 0 & -\sin\theta \\ 0 & 1 & 0 \end{bmatrix} \begin{bmatrix} 0 \\ 3 \\ 25 \end{bmatrix}$$

$$A_r = 25 \cos \theta = \frac{25}{\sqrt{26}} = 4.903$$

$$A_\theta = 25 \sin \theta = -25 \left(\frac{5}{\sqrt{26}} \right) = -24.51$$

$$A_\phi = 0.$$

$$\bar{A} \times \bar{B} = \begin{vmatrix} \bar{a}_r & \bar{a}_\theta & \bar{a}_\phi \\ 4.903 & -24.51 & 0 \\ -15.6 & 0 & 10 \end{vmatrix} = -245.1\bar{a}_r + 49.03\bar{a}_\theta - 382.43\bar{a}_\phi$$

$$\bar{a}_{A \times B} = \frac{\pm \bar{A} \times \bar{B}}{456.87} = \underline{\underline{\pm(0.5365\bar{a}_r - 0.1073\bar{a}_\theta + 0.8371\bar{a}_\phi)}}.$$

Prob 2.22

(a) For $(x, y, z) = (2, 3, 6)$,

$$r = \sqrt{x^2 + y^2 + z^2} = 7$$

$$x = r \cos \alpha \quad \cos \alpha = \frac{x}{r} = \frac{-2}{7}, \alpha = 106.6^\circ$$

$$y = r \cos \beta \quad \cos \beta = \frac{y}{r} = \frac{3}{7}, \beta = 64.6^\circ$$

$$z = r \cos \gamma \quad \cos \gamma = \frac{z}{r} = \frac{6}{7}, \gamma = 31^\circ$$

Hence,

$$(r, \alpha, \beta, \gamma) = \underline{\underline{(7, 106.6^\circ, 64.6^\circ, 31^\circ)}}$$

(b) For $(\rho, \phi, z) = (4, 30^\circ, -3)$,

$$r = \sqrt{\rho^2 + z^2} = 5,$$

$$\cos y = \frac{z}{r} = \frac{-3}{5} \quad y = 126.9^\circ$$

$$\cos \alpha = \frac{x}{r} = \rho \frac{\cos \phi}{r} = \frac{4 \cos 30^\circ}{5} \quad \alpha = 46.15^\circ$$

$$\cos B = \frac{y}{r} = \frac{\rho \sin \phi}{r} = \frac{4}{5} \sin 30^\circ \quad B = 66.42^\circ$$

$$(r, \alpha, B, y) = \underline{\underline{(5, 46.15^\circ, 66.42^\circ, 126.9^\circ)}}$$

(c) For $(r, \theta, \phi) = (3, 30^\circ, 60^\circ)$,

$$r = 3, \quad y = \theta = 30^\circ,$$

$$\cos \alpha = \frac{x}{r} = \frac{r \sin \theta \cos \phi}{r} = \frac{1}{4} \quad \alpha = 75.52^\circ,$$

$$\cos B = \frac{y}{r} = \sin \theta \sin \phi = 0.433 \quad B = 64.34^\circ,$$

$$(r, \alpha, B, y) = \underline{\underline{(3, 75.52^\circ, 64.34^\circ, 30^\circ)}}.$$

Prob 2.23

$$\bar{G} = \cos y \bar{a}_y + \frac{2r \cos \theta \sin \phi}{r \sin \theta} \bar{a}_y + (1 - \cos^2 \phi) \bar{a}_z$$

$$= \cos \phi \bar{a}_x + 2 \tan \theta \sin \phi \bar{a}_y + \sin \phi \bar{a}_z$$

$$\begin{pmatrix} G_r \\ G_\theta \\ G_\phi \end{pmatrix} = \begin{bmatrix} \sin \theta \cos \phi & \sin \theta \cos \phi & \cos \theta \\ \sin \theta \cos \phi & \cos \theta \sin \phi & -\sin \theta \\ -\sin \phi & \cos \phi & 0 \end{bmatrix} \begin{bmatrix} \cos^2 \phi \\ 2 \tan \theta \sin \phi \\ \sin^2 \phi \end{bmatrix}$$

$$G_r = \sin \theta \cos \phi + 2 \cos \theta \sin^2 \phi + \cos \theta \sin^2 \phi$$

$$= \sin \theta \cos^2 \phi + 3 \cos \theta \sin^2 \phi$$

$$G_\theta = \cos \theta \cos^2 \phi + 2 \tan \theta \cos \theta \sin^2 \phi - \sin \theta \sin^2 \phi$$

$$G_\phi = -\sin \phi \cos^2 \phi + \sin^2 \phi \cos \phi = \sin \phi \cos \phi (\sin \phi - \cos \phi)$$

$$\bar{G} = [\sin \theta \cos^2 \phi + 3 \cos \theta \sin^2 \phi] \bar{a}_x$$

$$+ [\cos \theta \cos^2 \phi + 2 \tan \theta \cos \theta \sin^2 \phi - \sin \theta \sin^2 \phi] \bar{a}_\theta$$

$$+ \underline{\underline{\sin \phi \cos \phi (\sin \phi - \cos \phi) \bar{a}_\phi}}$$

CHAPTER 3

P. E. 3.1

$$(a) DH = \int_{\phi=45^{\circ}}^{\phi=60^{\circ}} r \sin \phi \, d\phi \Big|_{r=3, \theta=90^{\circ}} = 3(1) \left[\frac{\pi}{3} - \frac{\pi}{4} \right] = \frac{\pi}{4} = \underline{\underline{0.7854}}$$

$$(b) FG = \int_{\theta=60^{\circ}}^{\theta=90^{\circ}} r \, d\theta \Big|_{r=5} = 5 \left(\frac{\pi}{2} - \frac{\pi}{3} \right) = \frac{5\pi}{6} = \underline{\underline{2.618}}$$

(c)

$$AEHD = \int_{\theta=60^{\circ}}^{\theta=90^{\circ}} \int_{\phi=45^{\circ}}^{\phi=60^{\circ}} r^2 \sin \theta \, d\theta \, d\phi \Big|_{r=3} = 9(-\cos \theta) \Big|_{\theta=60^{\circ}}^{\theta=90^{\circ}} \Big|_{\phi=45^{\circ}}^{\phi=60^{\circ}}$$

$$= 9 \left(\frac{1}{2} \right) \left(\frac{\pi}{12} \right) = \frac{3\pi}{8} = \underline{\underline{1.178}}$$

(d)

$$ABCD = \int_{r=3}^{r=5} \int_{\theta=60^{\circ}}^{\theta=90^{\circ}} r \, d\theta \, dr = \frac{r^2}{2} \Big|_{r=3}^{r=5} \left(\frac{\pi}{2} - \frac{\pi}{3} \right) = \frac{4\pi}{3} = \underline{\underline{4.189}}$$

(e)

$$\text{Volume} = \int_{r=3}^{r=5} \int_{\phi=45^{\circ}}^{\phi=60^{\circ}} \int_{\theta=60^{\circ}}^{\theta=90^{\circ}} r^2 \sin \theta \, d\theta \, d\phi = \frac{r^3}{3} \Big|_{r=3}^{r=5} (-\cos \theta) \Big|_{\theta=60^{\circ}}^{\theta=90^{\circ}} \Big|_{\phi=45^{\circ}}^{\phi=60^{\circ}} = \frac{1}{3} (98) \left(\frac{1}{2} \right) \frac{\pi}{12}$$

$$= \frac{49\pi}{36} = \underline{\underline{4.276}}$$

P.E. 3.2

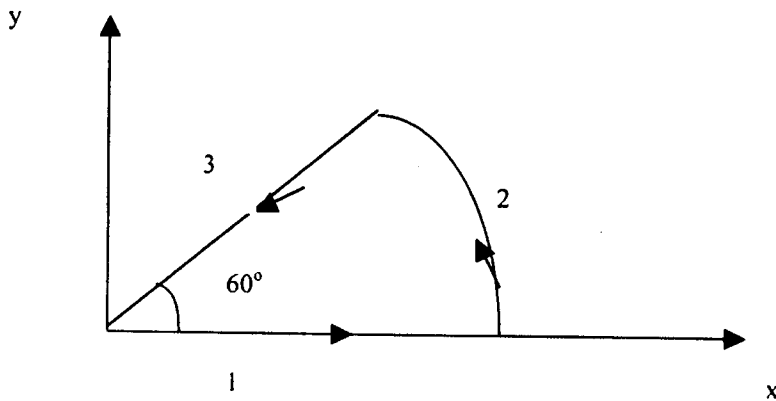

$$\oint \bar{A} \cdot \bar{dl} = \left(\int_1 + \int_2 + \int_3 \right) \bar{A} \cdot \bar{dl} = C_1 + C_2 + C_3$$

$$\text{Along (1), } C_1 = \int \bar{A} \cdot \bar{dl} = \int_0^2 \rho \cos \phi \, d\rho \Big|_{\phi=0} = \frac{\rho^2}{2} \Big|_0^2 = 2.$$

$$\text{Along (2), } \bar{dl} = \rho \, d\phi \, \bar{a}_\phi, \bar{A} \cdot \bar{dl} = 0, \quad C_2 = 0$$

$$\text{Along (3), } C_3 = \int_2^0 \rho \cos \phi \, d\rho \Big|_{\phi=60^\circ} = \frac{\rho^2}{2} \Big|_2^0 \left(\frac{1}{2} \right) = -1$$

$$\oint \bar{A} \cdot \bar{dl} = C_1 + C_2 + C_3 = 2 + 0 - 1 = \underline{1}$$

P.E. 3.3

$$\begin{aligned} \text{(a)} \quad \nabla U &= \frac{\partial U}{\partial x} \bar{a}_x + \frac{\partial U}{\partial y} \bar{a}_y + \frac{\partial U}{\partial z} \bar{a}_z \\ &= \underline{y(2x+z) \bar{a}_x + x(x+z) \bar{a}_y + xy \bar{a}_z} \end{aligned}$$

$$\begin{aligned} \text{(b)} \quad \nabla V &= \frac{\partial V}{\partial \rho} \bar{a}_\rho + \frac{1}{\rho} \frac{\partial V}{\partial \phi} \bar{a}_\phi + \frac{\partial V}{\partial z} \bar{a}_z \\ &= \underline{(z \sin \phi + 2\rho) \bar{a}_\rho + (z \cos \phi - \frac{z}{\rho} \sin 2\phi) \bar{a}_\phi + (\rho \cos \phi + 2z \cos^2 \phi) \bar{a}_z} \end{aligned}$$

(c)

$$\begin{aligned} \nabla f &= \frac{\partial f}{\partial r} \bar{a}_r + \frac{1}{r} \frac{\partial f}{\partial \theta} \bar{a}_\theta + \frac{1}{r \sin \theta} \frac{\partial f}{\partial \phi} \bar{a}_\phi \\ &= (\cos \theta \sin \phi + 2r\phi) \bar{a}_r - \sin \theta \sin \phi \ln r \bar{a}_\theta \\ &\quad + \underline{(\cos \theta \cos \phi \ln r + r \operatorname{cosec} \theta) \bar{a}_\phi} \end{aligned}$$

P.E. 3.4

$$\nabla \Phi = (x+y) \bar{a}_x + (x+z) \bar{a}_y + (y+z) \bar{a}_z$$

$$\text{At } (1,2,3) \quad \nabla \Phi = \underline{(5,4,3)}$$

$$\nabla \Phi \cdot \bar{a}_l = (5,4,3) \cdot \frac{(2,2,1)}{3} = \frac{21}{3} = \underline{7},$$

$$\text{where } (2,2,1) = (3,4,4) - (1,2,3)$$

P.E. 3.5

$$\text{Let } f = x^2y + z - 3, \quad g = x \log z - y^2 + 4,$$

$$\nabla f = 2xy\bar{a}_x + x^2\bar{a}_y + \bar{a}_z,$$

$$\nabla g = \log z \bar{a}_x - 2y\bar{a}_y + \frac{x}{z} \bar{a}_z$$

At $P(-1, 2, 1)$,

$$\bar{n}_f = \pm \frac{\nabla f}{|\nabla f|} = - \frac{(-4\bar{a}_x + \bar{a}_y + \bar{a}_z)}{\sqrt{18}}$$

$$\cos\theta = \bar{n}_f \cdot \bar{n}_g = \pm \frac{(-5)}{\sqrt{18 \times 17}}$$

$$\theta = \cos^{-1} \frac{5}{17.493} = \underline{\underline{73.39^\circ}}$$

P.E. 3.6

$$(a) \quad \nabla \cdot \bar{A} = \frac{\partial A_x}{\partial x} + \frac{\partial A_y}{\partial y} + \frac{\partial A_z}{\partial z} = 0 + 4 + 0 = \underline{\underline{4x}}$$

At $(1, -2, 3)$, $\nabla \cdot \bar{A} = \underline{\underline{4}}$.

(b)

$$\begin{aligned} \nabla \cdot \bar{B} &= \frac{1}{\rho} \frac{\partial}{\partial \rho} (\rho B_\rho) + \frac{1}{\rho} \frac{\partial B_\phi}{\partial \phi} + \frac{\partial B_z}{\partial z} \\ &= \frac{1}{\rho} 2\rho z \sin\phi - \frac{1}{\rho} 3\rho z^2 \sin\phi + 2z \sin\phi - 3z^2 \sin\phi \\ &= \underline{\underline{(2 - 3z)z \sin\phi}}. \end{aligned}$$

$$\text{At } (5, \frac{\pi}{2}, 1), \quad \nabla \cdot \bar{B} = (2 - 3)(1) = \underline{\underline{-1}}.$$

(c)

$$\begin{aligned} \nabla \cdot \bar{C} &= \frac{1}{r^2} \frac{\partial}{\partial r} (r^2 A_r) + \frac{1}{r \sin\theta} \frac{\partial}{\partial \theta} (A_\theta \sin\theta) + \frac{1}{r \sin\theta} \frac{\partial A_\phi}{\partial \phi} \\ &= \frac{1}{r^2} 6r^2 \cos\theta \cos\phi \\ &= \underline{\underline{6 \cos\theta \cos\phi}} \end{aligned}$$

$$\text{At } (1, \frac{\pi}{6}, \frac{\pi}{3}), \quad \nabla \cdot \bar{C} = 6 \cos \frac{\pi}{6} \cos \frac{\pi}{3} = \underline{\underline{2.598}}$$

P.E. 3.7 This is similar to Example 3.7.

$$\Psi = \oint_S \bar{A} \cdot d\bar{s} = \Psi_i + \Psi_h + \Psi_c$$

$\Psi_i = 0 = \Psi_h$ since \bar{A} has no z-component

$$\begin{aligned} \Psi_c &= \iint \rho^2 \cos^2 \phi \rho d\phi dz = \rho^3 \int_{\phi=0}^{\phi=2\pi} \cos^2 \phi d\phi \int_{z=0}^{z=l} dz \\ &= (4)^3 \pi (l) = 64\pi \\ \Psi &= 0 + 0 + 64\pi = \underline{\underline{64\pi}} \end{aligned}$$

By the divergence theorem,

$$\begin{aligned} \oint_S \bar{A} \cdot d\bar{s} &= \oint_V \nabla \cdot \bar{A} dv \\ \nabla \cdot \bar{A} &= \frac{1}{\rho} \frac{\partial}{\partial \rho} (\rho^3 \cos^2 \phi) + \frac{1}{\rho} \frac{\partial}{\partial \phi} z \sin \phi + \frac{\partial A_z}{\partial z} \\ &= 3\rho \cos^2 \phi + \frac{1}{\rho} \cos \phi. \end{aligned}$$

$$\begin{aligned} \Psi &= \int_V \nabla \cdot \bar{A} dv = \int_V (3\rho \cos^2 \phi + \frac{1}{\rho} \cos \phi) \rho d\phi dz d\rho \\ &= 3 \int_0^4 \rho^2 d\rho \int_0^{2\pi} \cos^2 \phi d\phi \int_0^l dz + \int_0^4 d\rho \int_0^{2\pi} \cos \phi d\phi \int_0^l dz \\ &= 3 \left(\frac{4^3}{3} \right) \pi (l) = \underline{\underline{64\pi}}. \end{aligned}$$

P.E. 3.8

(a)

$$\begin{aligned} \nabla \times \bar{A} &= \bar{a}_x(l-0) + \bar{a}_y(y-0) + \bar{a}_z(4y-z) \\ &= \underline{\underline{\bar{a}_x + y\bar{a}_y + (4y-z)\bar{a}_z}} \end{aligned}$$

$$\text{At } (l, -2, 3), \quad \nabla \times \bar{A} = \underline{\underline{\bar{a}_x - 2\bar{a}_y - 11\bar{a}_z}}$$

(b)

$$\begin{aligned} \nabla \times \bar{B} &= \bar{a}_\rho(0 - 6\rho z \cos \phi) + \bar{a}_\phi(\rho \sin \phi - 0) + \bar{a}_z \frac{1}{\rho} (6\rho z^2 \cos \phi - \rho z \cos \phi) \\ &= \underline{\underline{-6\rho z \cos \phi \bar{a}_\rho + \rho \sin \phi \bar{a}_\phi + (6z - 1)z \cos \phi \bar{a}_z}} \end{aligned}$$

$$\text{At } (5, \frac{\pi}{2}, -1), \quad \nabla \times \bar{B} = \underline{\underline{5\bar{a}_\phi}}$$

(c)

$$\begin{aligned}\nabla \times \bar{C} &= \bar{a}_r \frac{1}{r \sin \theta} (r^{-1/2} \cos \theta - 0) + \frac{\bar{a}_\theta}{r} \left(-\frac{2r \cos \theta \sin \phi}{\sin \theta} - \frac{3}{2} r^{1/2} \right) + \frac{\bar{a}_\phi}{r} (0 - 2r \sin \theta \cos \phi) \\ &= \underline{\underline{r^{-1/2} \cot \theta \bar{a}_r - (2 \cot \theta \sin \phi + \frac{3}{2} r^{1/2}) \bar{a}_\theta - 2 \sin \theta \cot \phi \bar{a}_\phi}}\end{aligned}$$

$$\text{At } (1, \frac{\pi}{6}, \frac{\pi}{3}), \quad \nabla \times C = \underline{\underline{1.732 \bar{a}_r - 4.5 \bar{a}_\theta - 0.5 \bar{a}_\phi}}$$

P.E. 3.9

$$\oint_L \bar{A} \cdot d\bar{l} = \int_S (\nabla \times \bar{A}) \cdot d\bar{S}$$

$$\text{But } (\nabla \times \bar{A}) = \sin \phi \bar{a}_z + \frac{z \cos \phi}{\rho} \bar{a}_\rho \quad \text{and} \quad d\bar{S} = \rho d\phi d\rho \bar{a}_z$$

$$\begin{aligned}\int_S (\nabla \times \bar{A}) \cdot d\bar{S} &= \iint \rho \sin \phi \, d\phi \, d\rho \\ &= \frac{\rho}{2} \left[-\cos \phi \right]_0^{60^\circ} \\ &= 2 \left(-\frac{1}{2} + 1 \right) = \underline{\underline{1}}.\end{aligned}$$

P.E. 3.10

$$\begin{aligned}\nabla \times \nabla V &= \begin{vmatrix} \frac{\partial}{\partial x} & \frac{\partial}{\partial y} & \frac{\partial}{\partial z} \\ \frac{\partial V}{\partial x} & \frac{\partial V}{\partial y} & \frac{\partial V}{\partial z} \end{vmatrix} \\ &= \left(\frac{\partial^2 V}{\partial y \partial z} - \frac{\partial^2 V}{\partial y \partial z} \right) \bar{a}_x + \left(\frac{\partial^2 V}{\partial x \partial z} - \frac{\partial^2 V}{\partial z \partial x} \right) \bar{a}_y + \left(\frac{\partial^2 V}{\partial x \partial y} - \frac{\partial^2 V}{\partial y \partial x} \right) \bar{a}_z = 0\end{aligned}$$

P.E. 3.11

(a)

$$\begin{aligned}\nabla^2 U &= \frac{\partial}{\partial x} (2xy + yz) + \frac{\partial}{\partial x} (x^2 + xz) + \frac{\partial}{\partial x} (xy) \\ &= \underline{\underline{2y}}.\end{aligned}$$

(b)

$$\begin{aligned}\nabla^2 V &= \frac{1}{\rho} \frac{\partial}{\partial \rho} \rho (z \sin \phi + 2\rho) + \frac{1}{\rho^2} (-\rho z \sin \phi - 2z^2) \frac{\partial}{\partial \rho} \sin \phi \cos \phi + \frac{\partial}{\partial z} (\rho \sin \phi + 2z \cos^2 \phi) \\ &= \frac{1}{\rho} (z \sin \phi + 4\rho) - \frac{1}{\rho^2} (z \rho \sin \phi + 2z^2 \cos 2\phi) + 2 \cos^2 \phi. \\ &= \underline{\underline{4 + 2 \cos^2 \phi - \frac{2z^2}{\rho^2} \cos 2\phi.}}\end{aligned}$$

(c)

$$\begin{aligned}\nabla^2 f &= \frac{l}{r^2} \frac{\partial}{\partial r} \left[\frac{l}{r^2} \frac{l}{r} \cos \theta \sin \phi + 2r^2 \phi \right] + \frac{l}{r^2 \sin \theta} \frac{\partial}{\partial \theta} [-\sin^2 \theta \sin \phi \ln r] \\ &\quad + \frac{l}{r^2 \sin^2 \theta} [-\cos \theta \sin \theta \ln r] \\ &= \underline{\underline{\frac{l}{r^2} \cos \theta \sin \phi (l - 2 \ln r - \csc^2 \theta \ln r) + 6\theta}}\end{aligned}$$

P.E. 3.12

If \vec{B} is conservative, $\nabla \times \vec{B} = 0$ must be satisfied.

$$\nabla \times \vec{B} = \begin{vmatrix} \frac{\partial}{\partial x} & \frac{\partial}{\partial y} & \frac{\partial}{\partial z} \\ y + z \cos xz & x & x \cos xz \end{vmatrix}$$

$$= 0 \vec{a}_x + (\cos xz - xz \sin xz - \cos xz + xz \sin xz) \vec{a}_y + (l - l) \vec{a}_z = 0$$

Hence \vec{B} is a conservative field.

Prob. 3.1

(a)

$$dl = \rho d\phi; \quad \rho = 3$$

$$L = \int dl = 3 \int_{\frac{\pi}{4}}^{\frac{\pi}{2}} d\phi = 3 \left(\frac{\pi}{2} - \frac{\pi}{4} \right) = \frac{3\pi}{4} = \underline{\underline{2.356}}$$

(b)

$$dl = r \sin \theta d\phi; \quad r = 1, \quad \theta = 30^\circ;$$

$$L = \int dl = r \sin \theta \int_0^{\frac{\pi}{3}} d\phi = (1) \sin 30^\circ \left[\left(\frac{\pi}{3} \right) - 0 \right] = \underline{\underline{0.5236}}$$

(c)

$$dl = r d\phi$$

$$L = \int dl = r \int_{\frac{\pi}{6}}^{\frac{\pi}{2}} d\theta = 4 \left(\frac{\pi}{2} - \frac{\pi}{6} \right) = \frac{4\pi}{3} = \underline{\underline{4.189}}$$

Prob. 3.2

(a)

$$dS = \rho d\phi dz$$

$$S = \int dS = \rho \int \int d\phi dz = 2 \int_0^5 dz \int_{\frac{\pi}{3}}^{\frac{\pi}{2}} d\phi = 2(5) \left[\frac{\pi}{2} - \frac{\pi}{3} \right] = \frac{10\pi}{6} = \underline{\underline{5.236}}$$

(b)

In cylindrical, $dS = \rho d\rho d\phi$

$$S = \int dS = \int_1^3 \rho d\rho \int_0^{\frac{\pi}{4}} d\phi = \frac{\pi}{4} \left(\frac{\rho^2}{2} \right) \Big|_1^3 = \underline{\underline{3.142}}$$

(c) In spherical, $dS = r^2 \sin \theta d\phi d\theta$

$$S = \int dS = 100 \int_{\frac{\pi}{4}}^{\frac{2\pi}{3}} \sin \theta d\theta \int_0^{2\pi} d\phi = 100(2\pi)(-\cos \theta) \Big|_{\frac{\pi}{4}}^{\frac{2\pi}{3}} = 200\pi(0.5 - 0.7071) = \underline{\underline{7.584}}$$

(d)

$$dS = r dr d\theta$$

$$S = \int dS = \int_1^4 r dr \int_{\frac{\pi}{3}}^{\frac{\pi}{2}} d\theta = \frac{r^2}{2} \left[\left(\frac{\pi}{2} - \frac{\pi}{3} \right) \right] = \frac{8\pi}{6} = \underline{\underline{4.189}}$$

Prob.3.3

$$(a) dV = dx dy dz$$

$$V = \int dx dy dz = \int_0^1 dx \int_1^2 dy \int_{-3}^3 dz = (1)(2-1)(3-(-3)) = \underline{\underline{6}}$$

$$(b) dV = \rho d\phi d\rho dz$$

$$V = \int_2^5 \rho d\rho \int_1^4 dz \int_{\frac{\pi}{3}}^{\pi} d\phi = \frac{\rho^2}{2} \Big|_2^5 (4-1) \left(\pi - \frac{\pi}{3}\right) = \frac{1}{2} (25-4)(5) \left(\frac{2\pi}{3}\right) = 35\pi = \underline{\underline{110}}$$

$$(c) dV = r^2 \sin\theta dr d\theta d\phi$$

$$V = \int_1^3 r^2 dr \int_{\frac{\pi}{2}}^{2\frac{\pi}{3}} \sin\theta d\theta \int_{\frac{\pi}{6}}^{\frac{\pi}{2}} d\phi = \frac{r^3}{3} \Big|_1^3 (-\cos\theta) \Big|_{\frac{\pi}{6}}^{\frac{\pi}{2}} \left(\frac{\pi}{2} - \frac{\pi}{6}\right)$$

$$= \frac{1}{3} (27-1) \left(\frac{1}{2}\right) \left(\frac{\pi}{3}\right) = \frac{26\pi}{18} = \underline{\underline{4.538}}$$

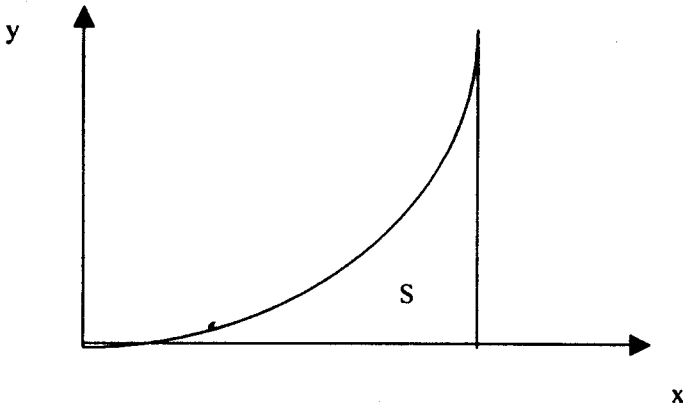
Prob 3.4

$$\int \rho_s dS = \int_{x=0}^{x=1} \int_{y=0}^{y=x^2} (x^2 + xy) dy dx$$

$$= \int_0^1 \left(x^2 y + \frac{xy^2}{2} \Big|_0^{x^2} \right) dx = \int_0^1 \left(x^4 + \frac{x^5}{2} \right) dx$$

$$= \frac{1}{5} + \frac{1}{12} = \frac{17}{60} = \underline{\underline{0.2833}}$$

Prob. 3.5

$$\int_L \vec{H} \cdot d\vec{l} = \int (x^2 dx + y^2 dy)$$

But on L , $y = x^2$ $dy = 2x dx$

$$\int_L \vec{H} \cdot d\vec{l} = \int_0^1 (x^2 + x^4 \cdot 2x) dx = \frac{x^3}{3} + 2 \frac{x^6}{6} \Big|_0^1 = \frac{1}{3} + \frac{1}{3} = \underline{\underline{0.6667}}$$

Prob. 3.6

$$V = \int_{\phi=0}^{2\pi} \int_{\theta=0}^{\alpha} \int_{r=0}^a r^2 \sin\theta \, d\theta \, dr \, d\phi = \frac{2\pi a^3}{3} (1 - \cos\alpha)$$

$$V(\alpha = \frac{\pi}{3}) = \frac{2\pi a^3}{3} (1 - \frac{1}{2}) = \underline{\underline{\frac{\pi a^3}{3}}}$$

$$V(\alpha = \frac{\pi}{2}) = \frac{2\pi a^3}{3} (1 - 0) = \underline{\underline{\frac{2\pi a^3}{3}}}$$

Prob. 3.7

(a)

$$\begin{aligned} \int \vec{F} \cdot d\vec{l} &= \int_{y=0}^1 (x^2 - z^2) dy \Big|_{z=0}^{x=0} + \int_{x=0}^{x=2} 2xy dx \Big|_{z=0}^{y=1} + \int_{z=0}^{z=3} (-3xz^2) dz \Big|_{y=1}^{x=0} \\ &= 0 + 2(1) \frac{x^2}{2} \Big|_0^2 - 3(2) \frac{z^3}{3} \Big|_0^3 \\ &= 0 + 4 - 54 = \underline{\underline{-50}} \end{aligned}$$

(b)

Let $x = 2t$, $y = t$, $z = 3t$

$dx = 2dt$, $dy = dt$, $dz = 3dt$;

$$\int \vec{F} \cdot d\vec{l} = \int_0^1 (8t^2 - 5t^2 - 162t^3) dt = -\frac{79}{2} = \underline{\underline{-39.5}}$$

Prob. 3.8

$$\begin{aligned}
 \int \vec{H} \cdot d\vec{l} &= \int_{x=0}^1 (x-y) dx \Big|_{y=0} + \int_{z=0}^1 (x^2 + zy) dz \Big|_{y=0}^{y=0} \\
 &\quad + \int (x^2 + zy) dy + 5yz dz \Big|_{z=1-\frac{y}{2}}^{x=0} \\
 &= \frac{x^2}{2} \Big|_0^1 + 0 + \int_{y=0}^2 y \left(1 - \frac{y}{2}\right) dy + 5y \left(1 - \frac{y}{2}\right) \left(-\frac{dy}{2}\right) \\
 &= \frac{1}{2} + \int_0^2 \left(-\frac{3}{2}y + \frac{3y^2}{4}\right) dy \\
 &= \frac{1}{2} + \left(-\frac{3}{4}y^2 + \frac{y^3}{4}\right) \Big|_0^2 = \frac{1}{2} - 3 + 4 \\
 &= \underline{\underline{1.5}}
 \end{aligned}$$

Prob. 3.9

The surface S can be divided into 5 parts as shown below:

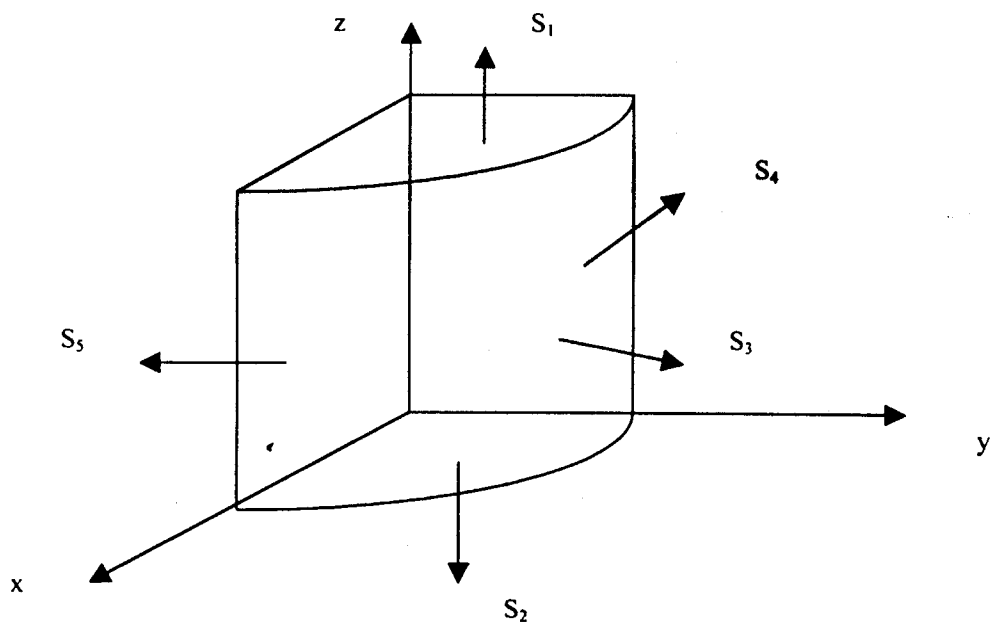

$$V = (x+y)z = \rho z(\cos\phi + \sin\phi)$$

Let

$$\bar{A} = \int V d\bar{S} = \left(\int_{S_1} + \int_{S_2} + \int_{S_3} + \int_{S_4} + \int_{S_5} \right) V d\bar{S} = \bar{A}_1 + \bar{A}_2 + \bar{A}_3 + \bar{A}_4 + \bar{A}_5$$

For \bar{A}_1 , $z = 2$, $d\bar{S} = \rho d\phi d\rho \bar{a}_z$,

$$\begin{aligned}\bar{A}_1 &= \int_{\rho=0}^1 \int_{\phi=0}^{\pi/2} \rho^2 z (\cos \phi + \sin \phi) d\phi d\rho \bar{a}_z = (2) \frac{\rho^3}{3} \Big|_0^1 (\sin \phi - \cos \phi) \Big|_0^{\pi/2} \bar{a}_z \\ &= \frac{2}{3} (1 - 0 - 0 + 1) \bar{a}_z = \frac{4}{3} \bar{a}_z\end{aligned}$$

For \bar{A}_2 , $z = 0$, $d\bar{S} = \rho d\phi (-\bar{a}_z)$,

$$\bar{A}_2 = - \int_{\rho=0}^1 \int_{\phi=0}^{\pi/2} \rho^2 z (\cos \phi + \sin \phi) d\phi d\rho \bar{a}_z = 0$$

For A_3 , $\rho = 1$, $d\bar{S} = \rho d\phi dz \bar{a}_\rho$

$$\begin{aligned}\bar{A}_3 &= \int_{z=0}^2 \int_{\phi=0}^{\pi/2} \rho^2 z (\cos \phi + \sin \phi) d\phi dz \bar{a}_\rho \\ &= (1^2) \frac{z^2}{2} \Big|_0^2 (1 + 1) \bar{a}_\rho = 4 \bar{a}_\rho\end{aligned}$$

For A_4 , $\phi = \frac{\pi}{2}$, $d\bar{S} = d\rho dz \bar{a}_\phi$

$$\begin{aligned}A_4 &= \int_{\rho=0}^1 \int_{z=0}^2 \rho z (\cos \phi + \sin \phi) d\rho dz \bar{a}_\phi \\ &= \frac{\rho^2}{2} \Big|_0^1 \frac{z^2}{2} \Big|_0^2 (0 + 1) \bar{a}_\phi = 1 \bar{a}_\phi\end{aligned}$$

For A_5 , $\phi = 0$, $d\bar{S} = d\rho dz (-\bar{a}_\phi)$

$$A_5 = -\bar{a}_\phi$$

Thus, $\bar{A} = \int V d\bar{S} = \frac{4}{3} \bar{a}_z + 0 + 4 \bar{a}_\rho - \bar{a}_\phi = \underline{\underline{4 \bar{a}_\rho + 1.333 \bar{a}_z}}$

Prob 3.10

$$\begin{aligned}(a) \int \bar{A} dv &= \int 2xy dx dy dz \bar{a}_x + \int xz dx dy dz \bar{a}_y - \int y dx dy dz \bar{a}_z \\ &= 2 \int_0^2 \int_0^2 \int_0^2 x dy \int_0^2 dz \bar{a}_x + \int_0^2 \int_0^2 \int_0^2 x dx \int_0^2 dy \int_0^2 dz \bar{a}_y + \int_0^2 \int_0^2 \int_0^2 dx \int_0^2 y dy \int_0^2 dz \bar{a}_z\end{aligned}$$

Since $\int_0^2 x dx = \frac{x^2}{2} \Big|_0^2 = 2$ and $\int_0^2 dx = 2$, we get

$$\int \bar{A} dv = 2(2)(2)(2)\bar{a}_x + (2)(2)(2)\bar{a}_y - (2)(2)(2)\bar{a}_z$$

$$= 16\bar{a}_x + 8\bar{a}_y - 8\bar{a}_z$$

$$\begin{bmatrix} A_\rho \\ A_\phi \\ A_z \end{bmatrix} = \begin{bmatrix} \cos\phi & \sin\phi & 0 \\ -\sin\phi & \cos\phi & 0 \\ 0 & 0 & 1 \end{bmatrix} \begin{bmatrix} 2xy \\ xz \\ -y \end{bmatrix}$$

$$A_\rho = 2xy \cos\phi + xz \sin\phi = 2\rho^2 \cos^3\phi \sin\phi + \rho z \cos\phi \sin\phi$$

$$A_\phi = -2xy \sin\phi + xz \cos\phi = -2\rho^2 \cos\phi \sin^2\phi + \rho z \cos^2\phi$$

$$A_z = -y = -\rho \cos\phi$$

$$dv = \rho d\phi d\rho dz$$

$$\int \bar{A} dv = \iiint 2\rho^3 \cos^3\phi d(-\cos\phi) d\rho dz \bar{a}_\rho + \iiint \rho^2 z \cos\phi d(-\cos\phi) d\rho dz \bar{a}_\rho$$

$$- 2 \iiint \rho^3 \sin^2\phi d(\sin\phi) d\rho dz \bar{a}_\phi + \iiint \rho^2 z \cos^2\phi d\phi d\rho dz \bar{a}_\phi$$

$$- \iiint \rho^2 \cos\phi d\phi d\rho dz \bar{a}_z$$

Since $\int_0^{2\pi} \cos\phi d\phi = 0$,

$$\int \int \bar{A} dv = -2 \frac{\rho^4}{4} \Big|_0^3 \cos^4\phi \Big|_0^{2\pi} z \Big|_0^3 \bar{a}_\rho - \frac{\rho^3}{3} \Big|_0^3 \frac{z^2}{2} \Big|_0^3 \frac{\cos^2\phi}{2} \Big|_0^{2\pi} \bar{a}_\rho$$

$$- \frac{2\rho^4}{4} \Big|_0^3 z \Big|_0^3 \frac{\sin^3\phi}{3} \Big|_0^{2\pi} \bar{a}_\phi + \frac{\rho^3}{3} \Big|_0^3 \frac{z^2}{2} \Big|_0^3 \left(\frac{1}{2} + \frac{1}{4} \sin 2\phi \right) \Big|_0^{2\pi} \bar{a}_\phi$$

$$= 0 + 0 + 0 + (9) \left(\frac{25}{2} \right) \left(\frac{1}{2} \right) \bar{a}_\phi = \underline{\underline{56.25 \bar{a}_\phi}}$$

(c)

$$\begin{bmatrix} A_r \\ A_\theta \\ A_\phi \end{bmatrix} = \begin{bmatrix} \sin\theta \cos\phi & \cos\theta \cos\phi & -\sin\theta \\ \sin\theta \sin\phi & \cos\theta \sin\phi & \cos\phi \\ \cos\theta & -\sin\theta & 0 \end{bmatrix} \begin{bmatrix} 2xy \\ xz \\ -y \end{bmatrix}$$

$$\begin{aligned}
\int \bar{A} dv &= \iiint 2r^4 \sin^4 \theta \cos^2 \phi \, d(\cos \phi) d\theta d\phi dr \bar{a}_r \\
&+ \iiint r^4 \sin^2 \theta \cos^2 \theta \cos^2 \phi \, d\theta d\phi dr \bar{a}_r \\
&+ \iiint r^4 \sin^2 \theta \cos \phi \sin \phi \, d\theta d\phi dr \bar{a}_r \\
&+ \iiint 2r^4 \sin^4 \theta \sin^2 \phi \, d(\sin \phi) d\theta d\phi dr \bar{a}_\theta \\
&+ \iiint r^4 \sin^2 \theta \cos^2 \theta \cos \phi \sin \phi \, d\theta d\phi dr \bar{a}_\theta \\
&- \iiint r^3 \sin^2 \theta \cos \phi \sin \phi \, d\theta d\phi dr \bar{a}_\theta \\
&+ \iiint 2r^4 \sin^2 \theta \cos \theta \sin \phi \cos \phi \, d\theta d\phi dr \bar{a}_\phi \\
&- \iiint r^4 \sin^3 \theta \cos^2 \theta \cos \phi \, d\theta d\phi dr \bar{a}_\phi
\end{aligned}$$

$$= \frac{r^5}{5} \Big|_0^1 \left(\frac{1}{2} + \frac{1}{4} \cos 2\phi \right) \Big|_0^\pi \int_0^\pi \cos \theta (1 - \cos^2 \theta) d\theta \bar{a}_r$$

$$= 204.8 \left(\frac{1}{2} \right) \left[\int_0^\pi \cos^2 \theta d\theta - \int_0^\pi \cos^4 \theta d\theta \right] \bar{a}_r$$

$$\text{But } \int_0^\pi \cos^2 \theta d\theta = \left(\frac{\theta}{2} + \frac{\sin 2\theta}{4} \right) \Big|_0^\pi = \frac{\pi}{2}$$

$$\text{Since } \cos 4\theta = 8 \cos^4 \theta - 8 \cos^2 \theta - 1$$

$$\begin{aligned}
\int_0^\pi \cos^4 \theta d\theta &= \frac{\pi}{2} + \frac{1}{8} \int_0^\pi \cos 4\theta d\theta - \frac{1}{8} \int_0^\pi d\theta \\
&= \frac{\pi}{2} + \frac{1}{8} \frac{1}{4} \sin 4\theta \Big|_0^\pi - \frac{\pi}{8} = \frac{\pi}{2} - \frac{\pi}{8}
\end{aligned}$$

$$\int \bar{A} dv = 102.4 \left(\frac{\pi}{2} - \frac{\pi}{2} + \frac{\pi}{8} \right) \bar{a}_r = \underline{\underline{40.21 \bar{a}_r}}$$

Prob 3.11

$$\bar{a} = \left(\frac{dV_x}{dt}, \frac{dV_y}{dt}, \frac{dV_z}{dt} \right) = 2.4 \bar{a}_z$$

$$\frac{dV_x}{dt} = 0 \quad \longrightarrow \quad V_x = A$$

$$\frac{dV_y}{dt} = 0 \quad \longrightarrow \quad V_y = B$$

$$\frac{dV_z}{dt} = 2.4 \quad \longrightarrow \quad V_z = 2.4t + C$$

At $t = 0$, $(V_x, V_y, V_z) = (-2, 0, 5)$. Hence,

$$A = -2, \quad B = 0, \quad C = 5$$

$$V_x = \frac{dx}{dt} = -2 \quad \longrightarrow \quad x = -2t + D$$

$$V_y = \frac{dy}{dt} = 0 \quad \longrightarrow \quad y = E$$

$$V_z = \frac{dz}{dt} = 2.4t + 5 \quad \longrightarrow \quad z = 1.2t^2 + 5t + F$$

At $t = 0$, $x = 0, y = 0, z = 0$. Hence, $D = 0 = E = F$

$$x = -2t, y = 0, z = 1.2t^2 + 5t$$

(a) At $t = 1$, $x = -2, y = 0, z = 6.2$. Thus the particle is at $(-2, 0, 6.2)$

(b) $\bar{V} = (V_x, V_y, V_z) = \underline{\underline{-2\bar{a}_x + (2.4t + 5)\bar{a}_z}}$ m/s

Prob 3.12

(a)

$$\begin{aligned} \bar{\nabla} U &= \frac{\partial U}{\partial x} \bar{a}_x + \frac{\partial U}{\partial y} \bar{a}_y + \frac{\partial U}{\partial z} \bar{a}_z \\ &= \underline{\underline{4z^2 \bar{a}_x + 3z \bar{a}_y + (8xz + 3y) \bar{a}_z}} \end{aligned}$$

(b)

$$\begin{aligned} \bar{\nabla} T &= \frac{\partial T}{\partial \rho} \bar{a}_\rho + \frac{1}{\rho} \frac{\partial T}{\partial \phi} \bar{a}_\phi + \frac{\partial T}{\partial z} \bar{a}_z \\ &= \underline{\underline{5e^{-2z} \sin \phi \bar{a}_\rho + 5e^{-2z} \cos \phi \bar{a}_\phi - 10\rho e^{-2z} \sin \phi \bar{a}_z}} \end{aligned}$$

(c)

$$\begin{aligned}\bar{\nabla} H &= \frac{\partial H}{\partial r} \bar{a}_r + \frac{1}{r} \frac{\partial H}{\partial \theta} \bar{a}_\theta + \frac{1}{r \sin \theta} \frac{\partial H}{\partial \phi} \bar{a}_\phi \\ &= \underline{\underline{2r \cos \theta \cos \phi \bar{a}_r - r \sin \theta \cos \phi \bar{a}_\theta - r \cos \theta \sin \phi \bar{a}_\phi}}\end{aligned}$$

Prob 3.13

$$\begin{aligned}(a) \nabla V &= \frac{\partial V}{\partial x} \bar{a}_x + \frac{\partial V}{\partial y} \bar{a}_y + \frac{\partial V}{\partial z} \bar{a}_z \\ &= \underline{\underline{2e^{(2x+3y)} \cos 5z \bar{a}_x + 3e^{(2x+3y)} \cos 5z \bar{a}_y - 5e^{(2x+3y)} \sin 5z \bar{a}_z}}\end{aligned}$$

At $(0.1, -0.2, 0.4)$

$$e^{(2x+3y)} = e^{0.2-0.6} = 0.6703, \quad \cos 5z = \cos 2 = -0.4161, \quad \sin 5z = 0.9092$$

$$\begin{aligned}\nabla V &= 2(0.6703)(-0.4161) \bar{a}_x + 3(0.6703)(-0.4161) \bar{a}_y - 5(0.6703)(0.9092) \bar{a}_z \\ &= \underline{\underline{-0.5578 \bar{a}_x - 0.8367 \bar{a}_y - 3.047 \bar{a}_z}}\end{aligned}$$

(b)

$$\nabla T = \underline{\underline{5e^{-2z} \sin \phi \bar{a}_\rho + 5e^{-2z} \cos \phi \bar{a}_\phi - 10\rho e^{-2z} \sin \phi \bar{a}_z}}$$

At $(2, \frac{\pi}{3}, 0)$,

$$\begin{aligned}\nabla T &= (5)(1)(0.5) \bar{a}_\rho + 5(1)(0.5) \bar{a}_\phi - 10(2)(1)(0.866) \bar{a}_z \\ &= \underline{\underline{2.5 \bar{a}_\rho + 2.5 \bar{a}_\phi - 17.32 \bar{a}_z}}\end{aligned}$$

(c)

$$\nabla Q = \underline{\underline{\frac{-2 \sin \theta \sin \phi}{r^3} \bar{a}_r + \frac{\cos \theta \sin \phi}{r^3} \bar{a}_\theta + \frac{\cos \phi}{r^3} \bar{a}_\phi}}$$

At $(1, 30^\circ, 90^\circ)$,

$$\nabla Q = \frac{-2(0.5)(1)}{1} \bar{a}_r + \frac{(0.86)(1)}{1} \bar{a}_\theta + 0 = \underline{\underline{-\bar{a}_r + 0.866 \bar{a}_\theta}}$$

Prob 3.14

$$\nabla S = 2x \bar{a}_x + 2y \bar{a}_y - \bar{a}_z$$

At $(1, 3, 0)$,

$$\nabla S = 2\bar{a}_x + 6\bar{a}_y - \bar{a}_z \quad \text{and} \quad \bar{a}_n = \frac{\nabla S}{|\nabla S|} = \frac{(2, 6, -1)}{\sqrt{4 + 36 + 1}}$$

$$\bar{a}_n = \underline{\underline{0.3123\bar{a}_x + 0.937\bar{a}_y - 0.1562\bar{a}_z}}$$

Prob 3.15

$$\nabla T = 2x\bar{a}_x + 2y\bar{a}_y - \bar{a}_z$$

At $(1, 1, 2)$, $\nabla T = (2, 2, -1)$. The mosquito should move in the direction of

$$\underline{\underline{2\bar{a}_x + 2\bar{a}_y - \bar{a}_z}}$$

Prob 3.16 (a)

$$\nabla \cdot \bar{A} = \underline{\underline{ye^{xy} + x \cos xy - 2x \cos xz \sin xz}}$$

$$\nabla \times \bar{A} = \begin{vmatrix} \frac{\partial}{\partial x} & \frac{\partial}{\partial y} & \frac{\partial}{\partial z} \\ e^{xy} & \sin xy & \cos^2 xz \end{vmatrix}$$

$$= (0 - 0)\bar{a}_x + (0 + 2z \cos xz \sin xz)\bar{a}_y + (y \cos xy - xe^{xy})\bar{a}_z$$

$$= \underline{\underline{z \sin 2xz \bar{a}_y + (y \cos xy - xe^{xy})\bar{a}_z}}$$

(b)

$$\nabla \cdot \bar{B} = \frac{1}{\rho} \frac{\partial}{\partial \rho} (\rho^2 z^2 \cos \phi) + 0 + \sin^2 \phi$$

$$= \underline{\underline{2z^2 \cos \phi + \sin^2 \phi}}$$

$$\nabla \times \bar{B} = \left(\frac{1}{\rho} \frac{\partial \bar{B}_z}{\partial \phi} - 0 \right) \bar{a}_\rho + \left(\frac{\partial \bar{B}_\rho}{\partial z} - \frac{\partial \bar{B}_z}{\partial \rho} \right) \bar{a}_\phi + \frac{1}{\rho} \left(0 - \frac{\partial \bar{B}_\rho}{\partial \phi} \right) \bar{a}_z$$

$$= \underline{\underline{\frac{z \sin 2\phi}{\rho} \bar{a}_\rho + 2\rho z \cos \phi \bar{a}_\phi + z^2 \sin \phi \bar{a}_z}}$$

(c)

$$\nabla \cdot \bar{C} = \frac{1}{r^2} \frac{\partial}{\partial r} (r^3 \cos \theta) + \frac{1}{r \sin \theta} \frac{\partial}{\partial \theta} \left(-\frac{1}{r} \sin^2 \theta \right) + 0$$

$$= \underline{\underline{3 \cos \theta - \frac{2 \cos \theta}{r^2}}}$$

$$\begin{aligned}\bar{\nabla} \times \bar{C} &= \frac{1}{r \sin \theta} \left[\frac{\partial}{\partial \theta} (2r^2 \sin^2 \theta) - 0 \right] \bar{a}_r + \frac{1}{r} \left[0 - \frac{\partial}{\partial r} (2r^3 \sin \theta) \right] \bar{a}_\theta \\ &\quad + \frac{1}{r} \left[\frac{\partial}{\partial r} (-\sin \theta) + r \sin \theta \right] \bar{a}_\phi \\ &= 4r \cos \theta \bar{a}_r - 6r \sin \theta \bar{a}_\theta + \sin \theta \bar{a}_\phi\end{aligned}$$

Prob 3.17 (a)

$$\bar{\nabla} \times \bar{A} = \begin{vmatrix} \frac{\partial}{\partial x} & \frac{\partial}{\partial y} & \frac{\partial}{\partial z} \\ x^2 y & y^2 z & -2xz \end{vmatrix} = \underline{\underline{-y^2 \bar{a}_x + 2z \bar{a}_y - y^2 \bar{a}_z}}$$

$$\bar{\nabla} \cdot \bar{\nabla} \times \bar{A} = \underline{\underline{0}}$$

(b)

$$\begin{aligned}\bar{\nabla} \times \bar{A} &= \left(\frac{1}{\rho} \frac{\partial A_z}{\partial \phi} - \frac{\partial A_\phi}{\partial z} \right) \bar{a}_\rho + \left(\frac{\partial A_\rho}{\partial z} - \frac{\partial A_z}{\partial \rho} \right) \bar{a}_\phi + \frac{1}{\rho} \left(\frac{\partial (\rho A_\phi)}{\partial \rho} - \frac{\partial A_\rho}{\partial \phi} \right) \bar{a}_z \\ &= (0 - 0) \bar{a}_\rho + (\rho^2 - 3z^2) \bar{a}_\phi + \frac{1}{\rho} (4\rho^3 - 0) \bar{a}_z \\ &= \underline{\underline{(\rho^2 - 3z^2) \bar{a}_\phi + 4\rho^2 \bar{a}_z}}\end{aligned}$$

$$\bar{\nabla} \cdot \bar{\nabla} \times \bar{A} = \underline{\underline{0}}$$

(c)

$$\begin{aligned}\bar{\nabla} \times \bar{A} &= \frac{1}{r \sin \theta} \frac{\partial}{\partial \theta} (-\sin \theta \cos \phi) \bar{a}_r + \left[\frac{1}{\sin \theta} \frac{\cos \phi}{r^2} - \frac{\partial}{\partial r} (r^{-1} \cos \theta) \right] \bar{a}_\theta + \frac{1}{r} (0 - 0) \bar{a}_\phi \\ &= \frac{-\cos \theta \cos \phi}{r \sin \theta} \bar{a}_r + \frac{1}{r} \left[\frac{\cos \phi}{r^2 \sin \theta} + r^{-2} \cos \theta \right] \bar{a}_\theta \\ &= \frac{-1}{r} \cot \theta \cos \phi \bar{a}_r + \frac{1}{r^3} \left(\frac{\cos \phi}{\sin \theta} + \cos \theta \right) \bar{a}_\theta\end{aligned}$$

$$\bar{\nabla} \cdot \bar{\nabla} \times \bar{A} = \underline{\underline{0}}$$

Prob 3.18

$$\bar{\nabla} \cdot \bar{H} = k \bar{\nabla} \cdot \bar{\nabla} T = k \bar{\nabla}^2 T$$

$$\bar{\nabla}^2 T = \frac{\partial^2 T}{\partial x^2} + \frac{\partial^2 T}{\partial y^2} = 50 \sin \frac{\pi x}{2} \cosh \frac{\pi y}{2} \left(-\frac{\pi^2}{4} + \frac{\pi^2}{4} \right) = 0$$

$$\text{Hence, } \bar{\nabla} \cdot \bar{H} = 0$$

Prob 3.19

(a)

$$\begin{aligned}
 \nabla \cdot (V \bar{A}) &= \frac{\partial}{\partial x}(V A_x) + \frac{\partial}{\partial y}(V A_y) + \frac{\partial}{\partial z}(V A_z) \\
 &= (A_x \frac{\partial V}{\partial x} + V \frac{\partial A_x}{\partial x}) + (A_y \frac{\partial V}{\partial y} + V \frac{\partial A_y}{\partial y}) + (A_z \frac{\partial V}{\partial z} + V \frac{\partial A_z}{\partial z}) \\
 &= V(\frac{\partial A_x}{\partial x} + \frac{\partial A_y}{\partial y} + \frac{\partial A_z}{\partial z}) + A_x \frac{\partial V}{\partial x} + A_y \frac{\partial V}{\partial y} + A_z \frac{\partial V}{\partial z} \\
 &= \underline{\underline{V \nabla \cdot \bar{A} + \bar{A} \cdot \nabla V}}
 \end{aligned}$$

(b)

$$\nabla \cdot \bar{A} = 2 + 3 - 4 = 1; \quad \nabla V = yz \bar{a}_x + xz \bar{a}_y + xy \bar{a}_z$$

$$\begin{aligned}
 \nabla \cdot (V \bar{A}) &= V \nabla \cdot \bar{A} + \bar{A} \cdot \nabla V \\
 &= xyz + 2xyz + 3xyz - 4xyz = \underline{\underline{2xyz}}
 \end{aligned}$$

Prob 3.20 (a)

$$\begin{aligned}
 \nabla \times V \bar{A} &= \begin{vmatrix} \frac{\partial}{\partial x} & \frac{\partial}{\partial y} & \frac{\partial}{\partial z} \\ VA_x & VA_y & VA_z \end{vmatrix} \\
 &= [\frac{\partial}{\partial y}(VA_z) - \frac{\partial}{\partial z}(VA_y)] \bar{a}_x + [\frac{\partial}{\partial z}(VA_x) - \frac{\partial}{\partial x}(VA_z)] \bar{a}_y \\
 &\quad + [\frac{\partial}{\partial x}(VA_y) - \frac{\partial}{\partial y}(VA_x)] \bar{a}_z \\
 &= [A_z \frac{\partial V}{\partial x} + V \frac{\partial A_z}{\partial y} - A_y \frac{\partial V}{\partial z} + V \frac{\partial A_y}{\partial z}] \bar{a}_x \\
 &\quad + [A_x \frac{\partial V}{\partial z} + V \frac{\partial A_x}{\partial z} - A_z \frac{\partial V}{\partial x} + V \frac{\partial A_z}{\partial x}] \bar{a}_y \\
 &\quad + [A_y \frac{\partial V}{\partial x} + V \frac{\partial A_y}{\partial x} - A_x \frac{\partial V}{\partial y} + V \frac{\partial A_x}{\partial y}] \bar{a}_z
 \end{aligned}$$

$$\begin{aligned}
&= V\left[\left(\frac{\partial A_z}{\partial y} - \frac{\partial A_y}{\partial z}\right)\bar{a}_x + \left(\frac{\partial A_x}{\partial z} - \frac{\partial A_z}{\partial x}\right)\bar{a}_y\right. \\
&\quad \left.+ \left(\frac{\partial A_y}{\partial x} + \frac{\partial A_x}{\partial y}\right)\bar{a}_z\right] \\
&\quad + \left(\frac{\partial V}{\partial x}\bar{a}_x + \frac{\partial V}{\partial y}\bar{a}_y + \frac{\partial V}{\partial z}\bar{a}_z\right) \times (A_x\bar{a}_y + A_y\bar{a}_x + A_z\bar{a}_z) \\
&= \underline{\underline{V(\nabla \times \bar{A}) + \nabla V \times \bar{A}}}
\end{aligned}$$

(b)

$$\begin{aligned}
V\bar{A} &= \frac{1}{r}\cos\theta\bar{a}_r + \frac{1}{r}\sin\theta\bar{a}_\theta + \frac{1}{r^2}\sin\theta\cos\phi\bar{a}_\phi \\
\nabla \times (V\bar{A}) &= \frac{1}{r\sin\theta}\left[\frac{2}{r^2}\sin\theta\cos\theta\cos\phi - 0\right]\bar{a}_r + \frac{1}{r}\left(0 + \frac{1}{r^2}\sin\theta\cos\phi\right)\bar{a}_\theta + \\
&\quad \frac{1}{r}\left(0 + \frac{1}{r}\sin\theta\right)\bar{a}_\phi \\
&= \underline{\underline{\frac{2\cos\theta\cos\phi}{r^3}\bar{a}_r + \frac{\sin\theta\cos\phi}{r^3}\bar{a}_\theta + \frac{\sin\theta}{r^2}\bar{a}_\phi}}
\end{aligned}$$

Prob 3.21

$$\begin{aligned}
\text{grad } U &= \frac{\partial U}{\partial x}\bar{a}_x + \frac{\partial U}{\partial y}\bar{a}_y + \frac{\partial U}{\partial z}\bar{a}_z \\
&= (z - 2xy)\bar{a}_x + (2yz^2 - x^2)\bar{a}_y + (x - 2y^2z)\bar{a}_z \\
\text{Div grad } U &= \nabla \cdot \nabla U = \frac{\partial}{\partial x}(z - 2xy) + \frac{\partial}{\partial y}(2yz^2 - x^2) + \frac{\partial}{\partial z}(x - 2y^2z) \\
&= -2y + 2z^2 - 2y^2 \\
&= \underline{\underline{2(z^2 - y^2 - y)}}
\end{aligned}$$

Prob 3.22

$$\begin{aligned}
\nabla \ln \rho &= \left(\frac{\partial}{\partial x} \ln \rho\right)\bar{a}_x + \left(\frac{\partial}{\partial y} \ln \rho\right)\bar{a}_y + \left(\frac{\partial}{\partial z} \ln \rho\right)\bar{a}_z \\
&= \frac{x}{\rho^2}\bar{a}_x + \frac{y}{\rho^2}\bar{a}_y
\end{aligned}$$

$$\begin{aligned}
 \nabla \times \phi \bar{a}_z &= \nabla \times \tan^{-1} \frac{y}{x} \bar{a}_z \\
 &= \begin{vmatrix} \frac{\partial}{\partial x} & \frac{\partial}{\partial y} & \frac{\partial}{\partial z} \\ 0 & 0 & \tan^{-1} \frac{y}{x} \end{vmatrix} \\
 &= \frac{x}{x^2 + y^2} \bar{a}_x + \frac{y}{x^2 + y^2} \bar{a}_y \\
 &= \frac{x}{\rho^2} \bar{a}_x + \frac{y}{\rho^2} \bar{a}_y \\
 &= \underline{\underline{\nabla \ln \rho, \text{ as expected!}}}
 \end{aligned}$$

Prob 3.23

$$\nabla \phi = \frac{l}{r \sin \theta} \bar{a}_\phi, \quad \nabla \theta = \frac{l}{r} \bar{a}_\theta$$

$$\frac{r \nabla \theta}{\sin \theta} = \frac{\bar{a}_\theta}{\sin \theta}$$

$$\nabla \times \left(\frac{r \nabla \theta}{\sin \theta} \right) = \frac{l}{r} \sin \theta \bar{a}_\theta$$

$$\text{Thus, } \nabla \phi = \underline{\underline{\nabla \times \left(\frac{r \nabla \theta}{\sin \theta} \right)}}$$

Prob 3.24

$$(a) \nabla V = \underline{\underline{(6xy + z) \bar{a}_x + 3x^2 \bar{a}_y + x \bar{a}_z}}$$

$$\nabla \cdot \nabla V = \underline{\underline{6y}}$$

$$\nabla \times \nabla V = \begin{vmatrix} \frac{\partial}{\partial x} & \frac{\partial}{\partial y} & \frac{\partial}{\partial z} \\ 6xy + z & 3x^2 & x \end{vmatrix} = \underline{\underline{0}}$$

$$(b) \nabla V = \underline{\underline{z \cos \phi \bar{a}_\rho - z \sin \phi \bar{a}_\phi + \rho \cos \phi \bar{a}_z}}$$

$$\nabla \cdot \nabla V = \frac{l}{\rho} \frac{\partial}{\partial \rho} (\rho z \cos \phi) + \frac{z}{\rho} \cos \theta + 0 = \frac{z}{\rho} \cos \phi - \frac{z}{\rho} \cos \phi = \underline{\underline{0}}$$

$$\nabla \times \nabla V = \underline{\underline{0}}$$

$$\begin{aligned}
 (c) \bar{V}V &= \frac{1}{r^2} (24r^2) \cos\theta \sin\phi + \frac{4r \cos\phi}{r \sin\theta} (\cos^2\theta \sin^2\theta) \\
 &\quad - \frac{4}{r^2 \sin^2\theta} \cos\theta \sin\phi \\
 &= \underline{\underline{24r \cos\theta \sin\phi + \frac{4 \cos\phi}{\sin\theta} - 8 \cos\phi \sin\theta - \frac{4 \cos\theta \sin\phi}{\sin^2\theta}}} \\
 \nabla \times \nabla V &= 0
 \end{aligned}$$

Prob. 3.25

(a)

$$(\bar{\nabla} \cdot \bar{r}) \bar{T} = 3\bar{T} = 6yz\bar{a}_y + 3xy^2\bar{a}_y + 3x^2yz\bar{a}_z$$

(b)

$$\begin{aligned}
 x \frac{\partial \bar{T}}{\partial x} + y \frac{\partial \bar{T}}{\partial y} + z \frac{\partial \bar{T}}{\partial z} &= x(y^2\bar{a}_y + 2xyz\bar{a}_z) + y(2z\bar{a}_x + 2xy\bar{a}_y + x^2z\bar{a}_x) \\
 &\quad + z(2y\bar{a}_x + x^2y\bar{a}_z) \\
 &= \underline{\underline{4yz\bar{a}_x + 3xy^2\bar{a}_y + 4x^2yz\bar{a}_z}}
 \end{aligned}$$

(c)

$$\begin{aligned}
 \nabla \cdot \bar{r}(\bar{r} \cdot \bar{T}) &= 3(2xyz + xy^3 + x^2yz^2) \\
 &= \underline{\underline{6xyz + 3xy^3 + 3x^2yz^2}}
 \end{aligned}$$

(d)

$$\begin{aligned}
 (\bar{r} \cdot \nabla) \bar{r} &= \left(x \frac{\partial}{\partial x} + y \frac{\partial}{\partial y} + z \frac{\partial}{\partial z}\right)(x^2 + y^2 + z^2) \\
 &= x(2x) + y(2y) + z(2z) \\
 &= \underline{\underline{2(x^2 + y^2 + z^2) = 2r^2}}
 \end{aligned}$$

Prob. 3.26

$$(a) \nabla r^n \bar{r} = \frac{\partial}{\partial x}(xr^n) + \frac{\partial}{\partial y}(yr^n) + \frac{\partial}{\partial z}(zr^n)$$

$$\text{where } r^n = (x^2 + y^2 + z^2)^{n/2}$$

$$\begin{aligned}\nabla r^n \bar{r} &= 2x^2 \left(\frac{n}{2}\right) (x^2 + y^2 + z^2)^{\frac{n}{2}-1} + 2y^2 \left(\frac{n}{2}\right) (x^2 + y^2 + z^2)^{\frac{n}{2}-1} \\ &\quad + 2z^2 \left(\frac{n}{2}\right) (x^2 + y^2 + z^2)^{\frac{n}{2}-1} + r^n + r^n + r^n \\ &= n(x^2 + y^2 + z^2) (x^2 + y^2 + z^2)^{\frac{n}{2}-1} + 3r^n \\ &= nr^n + 3r^n = \underline{\underline{(n+3)r^n}}\end{aligned}$$

$$\begin{aligned}(b) \nabla \times r^n \bar{r} &= \begin{vmatrix} \frac{\partial}{\partial x} & \frac{\partial}{\partial y} & \frac{\partial}{\partial z} \\ r^n x & r^n y & r^n z \end{vmatrix} \\ &= [2y \left(\frac{n}{2}\right) z (x^2 + y^2 + z^2)^{\frac{n}{2}-1} - 2z \left(\frac{n}{2}\right) y (x^2 + y^2 + z^2)^{\frac{n}{2}-1}] \bar{a}_x + \dots \\ &= 0\end{aligned}$$

Prob. 3.27

$$(a) \text{ Let } V = \ln r = \ln \sqrt{x^2 + y^2 + z^2}$$

$$\frac{\partial V}{\partial x} = \frac{1}{r} \frac{1}{2} (2x) (x^2 + y^2 + z^2)^{-\frac{1}{2}} = \frac{x}{r^2}$$

$$\nabla V = \frac{\partial V}{\partial x} \bar{a}_x + \frac{\partial V}{\partial y} \bar{a}_y + \frac{\partial V}{\partial z} \bar{a}_z = \frac{x\bar{a}_x + y\bar{a}_y + z\bar{a}_z}{r^2} = \underline{\underline{\frac{\bar{r}}{r^2}}}$$

$$(b) \text{ Let } \nabla V = \bar{A} = \frac{\bar{r}}{r^2} = \frac{1}{r} \bar{a}_x \text{ in spherical coordinates.}$$

$$\begin{aligned}\nabla^2 (\ln r) &= \nabla \cdot \nabla (\ln r) = \nabla \cdot \bar{A} = \frac{1}{r^2} \frac{\partial}{\partial r} (r^2 A_r) = \frac{1}{r^2} \frac{d}{dr} (r) \\ &= \underline{\underline{\frac{1}{r^2}}}\end{aligned}$$

Prob 3.28

(a)

$$\bullet V_1 = x^3 + y^3 + z^3$$

$$\begin{aligned}\nabla^2 V_1 &= \frac{\partial^2 V_1}{\partial x^2} + \frac{\partial^2 V_1}{\partial y^2} + \frac{\partial^2 V_1}{\partial z^2} \\ &= \frac{\partial}{\partial x} (3x^2) + \frac{\partial}{\partial y} (3y^2) + \frac{\partial}{\partial z} (3z^2) \\ &= 6x + 6y + 6z = \underline{\underline{6(x+y+z)}}\end{aligned}$$

(b)

$$V_2 = \rho z^2 \sin 2\phi$$

$$\begin{aligned}\nabla^2 V_2 &= \frac{1}{\rho} \frac{\partial}{\partial \rho} (\rho z^2 \sin 2\phi) - \frac{4z^2}{\rho} \sin 2\phi + \frac{\partial}{\partial z} (2\rho z \sin 2\phi) \\ &= \frac{z}{\rho} \sin 2\phi - \frac{4z^2}{\rho} \sin 2\phi + 2\rho \sin 2\phi \\ &= \underline{\underline{\left(\frac{-3z^2}{\rho} + 2\rho\right) \sin 2\phi}}\end{aligned}$$

(c)

$$V_3 = r^2(1 + \cos\theta \sin\phi)$$

$$\begin{aligned}\nabla^2 V_3 &= \frac{1}{r^2} \frac{\partial}{\partial r} [2r^3(1 + \cos\theta \sin\phi)] + \frac{1}{r^2 \sin\theta} \frac{\partial}{\partial \theta} (-\sin\theta \sin\phi) r^2 \\ &\quad + \frac{1}{r^2 \sin\theta} \frac{\partial}{\partial \theta} (-\sin^2\theta \sin\phi) r^2 + \frac{1}{r^2 \sin^2\theta} r^2 (-\cos\theta \sin\phi) \\ &= 6(1 + \cos\theta \sin\phi) - \frac{2\sin\theta}{\sin\theta} \cos\theta \sin\phi - \frac{\cos\theta \sin\phi}{\sin^2\theta} \\ &= \underline{\underline{6 + 4\cos\theta \sin\phi - \frac{\cos\theta \sin\phi}{\sin^2\theta}}}\end{aligned}$$

Prob 3.29

(a)

$$U = x^3 y^2 e^{-xz}$$

$$\begin{aligned}\nabla^2 U &= \frac{\partial}{\partial x} (3x^2 y^2 e^{-xz}) + \frac{\partial}{\partial y} (2x^2 y e^{-xz}) + \frac{\partial}{\partial z} (x^3 y^2 e^{-xz}) \\ &= 6xy^2 e^{-xz} + 2x^2 e^{-xz} + x^3 y^2 e^{-xz} = \underline{\underline{(6xy^2 + 2x^2 + x^3 y^2) e^{-xz}}}\end{aligned}$$

At $(1, -1, 1)$,

$$\nabla^2 U = e^{-1} (6 + 2 + 1) = 9e = \underline{\underline{24.46}}$$

(b)

$$V = \rho^2 z (\cos\phi + \sin\phi)$$

$$\begin{aligned}\nabla^2 V &= \frac{1}{\rho} \frac{\partial}{\partial \rho} [2\rho^2 z (\cos\phi + \sin\phi)] - z (\cos\phi + \sin\phi) + 0 \\ &= 4z (\cos\phi + \sin\phi) - z (\cos\phi + \sin\phi) \\ &= 3z (\cos\phi + \sin\phi)\end{aligned}$$

$$\text{At } \left(5, \frac{\pi}{6}, -2\right), \quad \nabla^2 V = -6(0.866 + 0.5) = \underline{\underline{-8.196}}$$

(c)

$$\begin{aligned}
 W &= e^{-r} \sin\theta \cos\phi \\
 \nabla^2 W &= \frac{1}{r^2} \frac{\partial}{\partial r} (-r^2 e^{-r} \sin\theta \cos\phi) + \frac{e^{-r}}{r^2 \sin\theta} \cos\phi \frac{\partial}{\partial \theta} (\sin\theta \cos\theta) \\
 &\quad - \frac{e^{-r} \sin\theta \cos\phi}{r^2 \sin^2\theta} \\
 &= \frac{1}{r^2} (-2re^{-r} \sin\theta \cos\phi) + e^{-r} \sin\theta \cos\phi \\
 &\quad + \frac{e^{-r} \cos\phi}{r^2 \sin\theta} (\cos^2\theta - \sin^2\theta) - \frac{-e^{-r} \cos\theta}{r^2 \sin\theta} \\
 \nabla^2 W &= \underline{\underline{e^{-r} \sin\theta \cos\phi (1 - \frac{4}{r})}}
 \end{aligned}$$

At $(1, 60^\circ, 30^\circ)$,

$$\nabla^2 W = e^{-1} \sin 60 \cos 30 (1 - 4) = -2.25e^{-1} = \underline{\underline{-0.8277}}$$

Prob 3.30

(a)

$$\begin{aligned}
 \nabla^2 V &= \frac{\partial^2 V}{\partial x^2} + \frac{\partial^2 V}{\partial y^2} + \frac{\partial^2 V}{\partial z^2} \\
 &= \underline{\underline{2(y^2 z^2 + x^2 z^2 + x^2 y^2)}}
 \end{aligned}$$

(b)

$$\begin{aligned}
 \nabla^2 \bar{A} &= \nabla^2 A_x \bar{a}_x + \nabla^2 A_y \bar{a}_y + \nabla^2 A_z \bar{a}_z \\
 &= (2y + 0 + 0) \bar{a}_x + (0 + 0 + 6xz) \bar{a}_y + (0 - 2z^2 - 2y^2) \bar{a}_z \\
 &= \underline{\underline{2y \bar{a}_x + 6xz \bar{a}_y - 2(y^2 + z^2) \bar{a}_z}}
 \end{aligned}$$

(c)

$$\begin{aligned}
 \text{grad div } A &= \nabla(\nabla \cdot \bar{A}) = \nabla(2xy + 0 - 2y^2 z) \\
 &= \underline{\underline{2y \bar{a}_x + 2(x - 2yz) \bar{a}_y - 2y^2 \bar{a}_z}}
 \end{aligned}$$

(d)

$$\text{curl curl } \bar{A} = \nabla \times \nabla \times \bar{A} = \nabla(\nabla \cdot \bar{A}) - \nabla^2 \bar{A}$$

From parts (b) and (c),

$$\nabla \times \nabla \times \bar{A} = \underline{\underline{2(x - 2yz - 3xz) \bar{a}_x + 2z^2 \bar{a}_z}}$$

Prob. 3.31

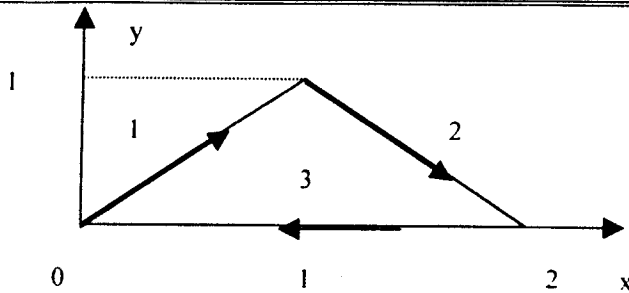

(a)

$$\oint_L \vec{F} \cdot d\vec{l} = \left(\int_1 + \int_2 + \int_3 \right) \vec{F} \cdot d\vec{l}$$

$$\text{For 1, } y = x \quad dy = dx, d\vec{l} = dx\vec{a}_x + dy\vec{a}_y.$$

$$\int_1 \vec{F} \cdot d\vec{l} = \int_0^1 (x^2 - x) dx = -\frac{1}{4}$$

$$\text{For 2, } y = -x + 2, dy = -dx, d\vec{l} = dx\vec{a}_x + dy\vec{a}_y.$$

$$\int_2 \vec{F} \cdot d\vec{l} = \int_1^2 (-x^3 + 2x^2 - x + 2) dx = \frac{17}{12}$$

For 3,

$$\int_3 \vec{F} \cdot d\vec{l} = \int_2^0 x^2 y dx \Big|_{y=0} = 0$$

$$\oint_L \vec{F} \cdot d\vec{l} = -\frac{1}{4} + \frac{17}{12} + 0 = \underline{\underline{\frac{7}{6}}}$$

(b)

$$\nabla \times \vec{F} = -x^2 \vec{a}_z; \quad d\vec{S} = dx dy (-\vec{a}_z)$$

$$\int (\nabla \times \vec{F}) \cdot d\vec{S} = - \iint (-x^2) dx dy = \int_0^1 \int_0^x x^2 dy dx + \int_1^2 \int_1^2 x^2 dy dx$$

$$= \int_0^1 x^2 y \Big|_0^x dx + \int_1^2 x^2 y \Big|_1^{x+2} dx = \frac{x^3}{4} \Big|_0^1 + \int_1^2 x^2 (-x+2) dx = \underline{\underline{\frac{7}{6}}}$$

(c) Yes

Prob 3.32

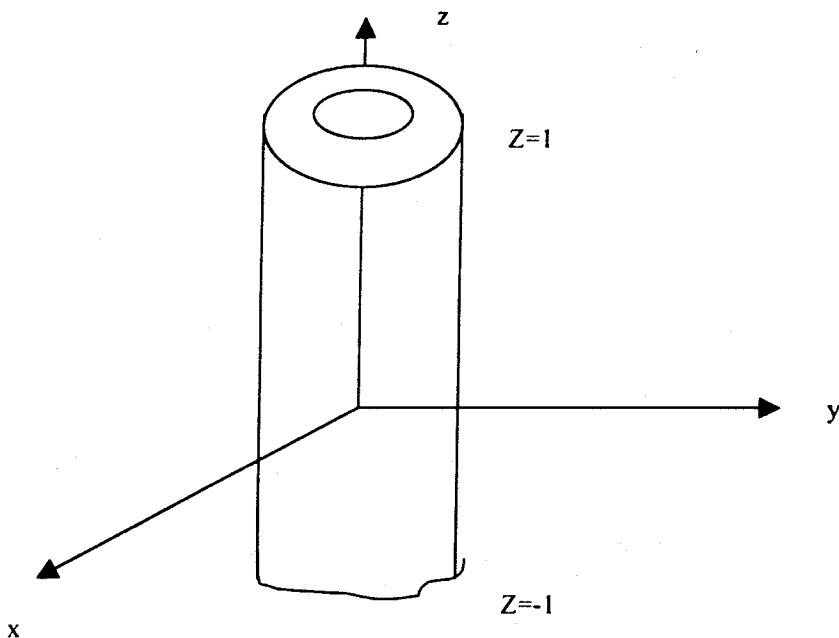

(a)

$$\oint \bar{D} \cdot d\bar{s} = \left[\iint_{z=-1} + \iint_{z=1} + \iint_{\rho=2} + \iint_{\rho=5} \right] \bar{D} \cdot d\bar{s}$$

$$= - \iint \rho^2 \cos^2 \phi \, d\phi \, d\rho + \iint \rho^2 \cos^2 \phi \, d\phi \, d\rho - \iint 2\rho^2 z^2 \, d\phi \, dz \Big|_{\rho=2} + \iint 2\rho^2 z^2 \, d\phi \, dz \Big|_{\rho=5}$$

$$= - 2(2)^2 \int_0^{2\pi} d\phi \int_{-1}^1 z^2 \, dz + 2(5)^2 \int_0^{2\pi} d\phi \int_{-1}^1 z^2 \, dz$$

$$= - 8(2\pi) \left(\frac{z^3}{3} \Big|_{-1}^1 \right) + 50(2\pi) \left(\frac{z^3}{3} \Big|_{-1}^1 \right)$$

$$= \frac{-32\pi}{3} + \frac{200\pi}{3} = \underline{\underline{176}}$$

$$(b) \nabla \cdot \bar{D} = \frac{1}{\rho} \frac{\partial}{\partial \rho} (2\rho^2 z^2) = 4z^2$$

$$\int \nabla \cdot D \, dv = \iiint 4z^2 \rho \, d\rho \, d\phi \, dz = 4 \int_{-1}^1 z^2 \, dz \int_2^5 \rho \, d\rho \int_0^{2\pi} d\phi$$

$$= 4x \frac{z^3}{3} \Big|_{-1}^1 \cdot \frac{\rho^2}{2} \Big|_2^5 (2\pi) = 56\pi = \underline{\underline{176}}$$

Prob 3.33

Transform \vec{F} into cylindrical system.

$$\begin{bmatrix} F_\rho \\ F_\phi \\ F_z \end{bmatrix} = \begin{bmatrix} \cos\phi & \sin\phi & 0 \\ -\sin\phi & \cos\phi & 0 \\ 0 & 0 & 1 \end{bmatrix} \begin{bmatrix} x^2 \\ y^2 \\ z^2 - 1 \end{bmatrix}$$

$$F_\rho = x^2 \cos\phi + y^2 \sin\phi = \rho^2 \cos^3\phi + \rho^2 \sin^3\phi, F_z = z^2 - 1$$

$$F_\phi = -x^2 \sin\phi + y^2 \cos\phi = -\rho^2 \cos^2\phi \sin\phi + \rho^2 \sin^2\phi \cos\phi$$

$$\begin{aligned} \nabla \cdot \vec{F} &= \frac{1}{\rho} \frac{\partial}{\partial \rho} (\rho^3 \cos^3\phi + \rho^3 \sin^3\phi) + 2z - \rho \cos^3\phi - 2\rho \cos\phi \sin^2\phi \\ &\quad + 2\rho \sin\phi \cos^2\phi + \rho \sin^3\phi \\ &= 2\rho \cos^3\phi + 4\rho \sin^3\phi - 2\rho \cos\phi \sin^2\phi + 2\rho \cos^2\phi \sin\phi + 2z \end{aligned}$$

$$\int \vec{F} \cdot d\vec{S} = \int \nabla \cdot \vec{F} \, dv$$

Due to the fact that we are integrating $\sin\phi$ and $\cos\phi$ over $0 < \phi < 2\pi$, all terms involving $\cos\phi$ and $\sin\phi$ will vanish. Hence,

$$\begin{aligned} \int \vec{F} \cdot d\vec{S} &= \iiint 2z \rho \, d\rho \, d\phi \, dz = 2 \int_0^{2\pi} d\phi \int_0^2 z \, dz \int_0^2 \rho \, d\rho \\ &= 2(2\pi) \left(\frac{2^2}{2} \right) = 16\pi \\ &= \underline{\underline{50.26}} \end{aligned}$$

Prob 3.34**(a)**

$$\oint \vec{A} \cdot d\vec{S} = \int_V \nabla \cdot \vec{A} \, dv, \quad \nabla \cdot \vec{A} = y + z + x$$

$$\begin{aligned} \oint \vec{A} \cdot d\vec{S} &= \int_0^1 \int_0^1 \int_0^1 (x + y + z) \, dx \, dy \, dz \\ &= 3 \int_0^1 x \, dx \int_0^1 dy \int_0^1 dz = 3 \left(\frac{x^2}{2} \Big|_0^1 \right) (1)(1) \\ &= \underline{\underline{1.5}} \end{aligned}$$

(b)

$$\nabla \cdot \vec{A} = 0. \quad \text{Hence,} \quad \oint \vec{A} \cdot d\vec{S} = \underline{\underline{0}}$$

Prob 3.35

(a)

$$\nabla \cdot \bar{A} = y^2 + 3y^2 + y^2 = 5y^2$$

$$\begin{aligned} \int \nabla \cdot \bar{A} \, dv &= \iiint 5y^2 \, dx \, dy \, dz \\ &= 5 \int_0^1 dx \int_0^1 y^2 \, dy \int_0^1 dz = 5(1)(1) \left(\frac{y^3}{3} \Big|_0^1 \right) = \underline{\underline{1.667}} \end{aligned}$$

$$\begin{aligned} \oint \bar{A} \cdot d\bar{S} &= \left[\iint_{x=0} + \iint_{x=1} + \iint_{y=0} + \iint_{y=1} + \iint_{z=0} + \iint_{z=1} \right] \bar{A} \cdot d\bar{S} \\ &= - \iint xy^2 \, dy \, dz \Big|_{x=0} + \iint xy^2 \, dy \, dz \Big|_{x=1} - \iint y^3 \, dx \, dz \Big|_{y=0} \\ &\quad + \iint y^3 \, dx \, dz \Big|_{y=1} - \iint y^2 z \, dx \, dy \Big|_{z=0} + \iint y^2 z \, dx \, dy \Big|_{z=1} \\ &= (1)(1) \left(\frac{y^3}{3} \Big|_0^1 \right) + (1)(1)(1) + (1)(1) \left(\frac{y^3}{3} \Big|_0^1 \right) = \underline{\underline{1.667}} \end{aligned}$$

(b)

$$\nabla \cdot \bar{A} = \frac{1}{\rho} \frac{\partial}{\partial \rho} (2\rho^2 z) + \frac{3z \cos \phi}{\rho} - 0 = 4z + \frac{3z \cos \phi}{\rho}$$

$$\begin{aligned} \int_V \nabla \cdot \bar{A} \, dv &= \iiint \left(4z + \frac{3z}{\rho} \cos \phi \right) \rho \, d\rho \, d\phi \, dz \\ &= 4 \int_0^2 \rho \, d\rho \int_0^5 z \, dz \int_0^{\pi} d\phi + 3 \int_0^2 \rho \, d\rho \int_0^5 z \, dz \int_0^{45^\circ} \cos \phi \, d\phi \\ &= 4 \left(\frac{4}{2} \right) \left(\frac{25}{2} \right) \left(\frac{11}{4} \right) + 3(2) \left(\frac{25}{2} \right) \sin 45^\circ \\ &= 25\pi + 75 \sin 45^\circ = \underline{\underline{131.57}} \end{aligned}$$

$$\begin{aligned} \oint_S \bar{A} \cdot d\bar{S} &= \left[\iint_{\rho=2} + \iint_{z=0} + \iint_{z=5} + \iint_{\phi=0} + \iint_{\phi=45^\circ} \right] \bar{A} \cdot d\bar{S} \\ &= J_1 + J_2 + J_3 + J_4 + J_5 \end{aligned}$$

$$\text{where } J_1 = \iint 2\rho z \rho d\phi dz \Big|_{\rho=2} = (2)(2)^2 \int_0^5 z dz \int_0^{\frac{\pi}{4}} d\phi = 25\pi$$

$$J_2 = \iint 4\rho \cos\phi d\rho \rho d\phi \Big|_{z=0} = -\frac{32}{3} \sin\frac{\pi}{4}$$

$$J_3 = -\iint 4\rho \cos\phi d\rho d\phi \Big|_{z=5} = \frac{32}{3} \sin\frac{\pi}{4}$$

$$J_4 = \iint 3z \sin\phi d\rho dz \Big|_{\rho=0} = 0$$

$$J_5 = \iint 3z \sin\phi d\rho d\phi \Big|_{z=\frac{\pi}{4}} = 75 \sin\frac{\pi}{4}$$

$$\oint \bar{A} \cdot d\bar{S} = 25\pi + 75 \sin\frac{\pi}{4} = \underline{\underline{131.57}}$$

(c)

$$\begin{aligned} \nabla \cdot \bar{A} &= \frac{1}{r^2} \frac{\partial}{\partial r} (r^4) + \frac{1}{\sin\theta} \frac{\partial}{\partial \theta} (r \sin^2\theta \cos\phi) \\ &= 4r + 2\cos\theta \cos\phi \end{aligned}$$

$$\begin{aligned} \int \nabla \cdot \bar{A} dv &= \iiint 4r^3 \sin\theta d\theta d\phi dr + \iiint 2r^2 \sin\theta \cos\theta \cos\phi d\theta d\phi dr \\ &= 4 \frac{r^4}{4} \Big|_0^3 (-\cos\theta) \Big|_0^{\pi/2} \left(\frac{\pi}{2}\right) + \frac{2r^3}{3} \Big|_0^3 \left(-\frac{\cos\theta}{2}\right) \Big|_0^{\pi/2} \sin\phi \Big|_0^{\pi} \\ &= 81(1)\left(\frac{\pi}{2}\right) + 18\left(0 + \frac{1}{2}\right)(1-0) \\ &= \frac{81\pi}{2} + 9 = \underline{\underline{136.23}} \end{aligned}$$

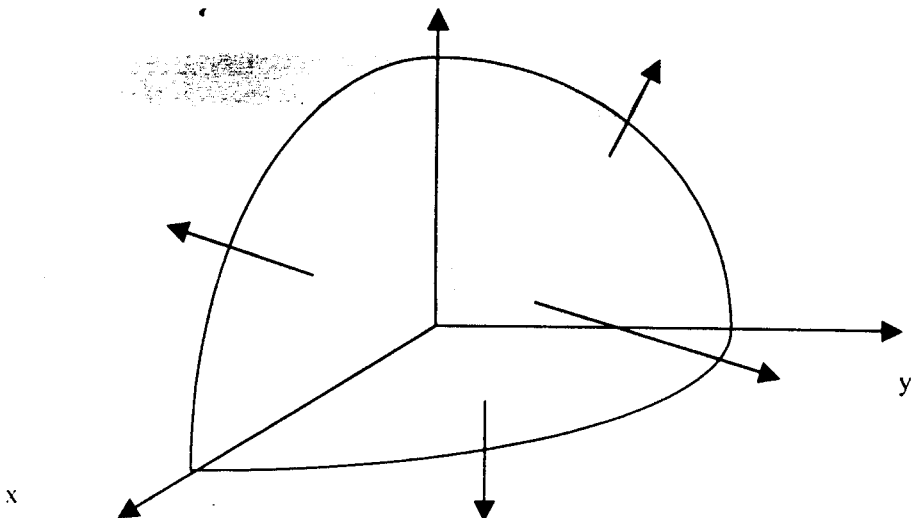

$$\int \bar{A} \cdot d\bar{S} = \left[\iint_{\phi=0} + \iint_{\phi=\pi/2} + \iint_{r=3} + \iint_{\theta=\pi/2} \right] \bar{A} \cdot d\bar{S}$$

Since \bar{A} has no ϕ -component, the first two integrals vanish.

$$\begin{aligned} \int \bar{A} \cdot d\bar{S} &= \int_{\phi=0}^{\pi/2} \int_{\phi=0}^{\pi/2} r^4 \sin\theta \, d\theta \, d\phi \Big|_{r=3} + \int_{r=0}^3 \int_{\phi=0}^{\pi/2} r^2 \sin^2\theta \cos\phi \, dr \, d\phi \Big|_{\theta=\pi/2} \\ &= 81 \left(\frac{\pi}{2} \right) (-\cos\theta) \Big|_0^{\pi/2} + 9(1) \sin\phi \Big|_0^{\pi/2} \\ &= \frac{81\pi}{2} + 9 = \underline{\underline{136.23}} \end{aligned}$$

Prob. 3.36

$$\int \rho_V \, dv = \oint_S \bar{A} \cdot d\bar{S} \quad (\text{divergence theorem})$$

where $\rho_V = \nabla \cdot \bar{A} = x^2 + y^2$

$$\frac{\partial A_x}{\partial x} = x^2 \longrightarrow A_x = \frac{x^3}{3} + C_1$$

$$\frac{\partial A_y}{\partial y} = y^2 \longrightarrow A_y = \frac{y^3}{3} + C_2$$

Hence,

$$\bar{A} = \underline{\underline{\left(\frac{x^3}{3} + C_1 \right) \bar{a}_x + \left(\frac{y^3}{3} + C_2 \right) \bar{a}_y}}$$

Prob. 3.37

(a)

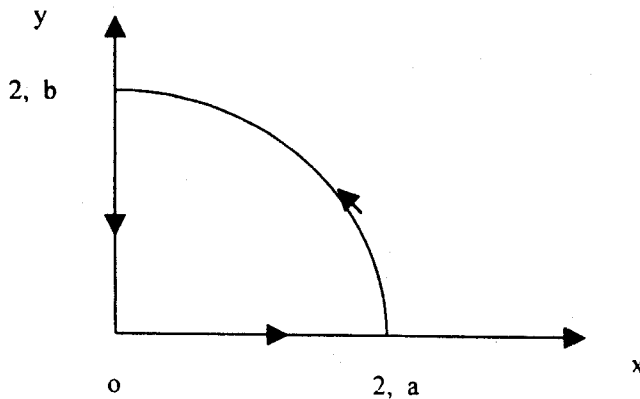

$$d\vec{l} = d\rho \vec{a}_\rho + \rho d\phi \vec{a}_\phi$$

$$\vec{A} \cdot d\vec{l} = \rho \sin\phi d\rho + \rho^3 d\phi$$

$$\text{Along } oa: d\phi = 0, \quad \phi = 0, \quad \vec{A} \cdot d\vec{l} = 0, \quad \int_0^a \vec{A} \cdot d\vec{l} = 0$$

$$\text{Along } ob: d\rho = 0, \quad \rho = 2, \quad \int_a^b \vec{A} \cdot d\vec{l} = 0, \quad \int_0^{\frac{\pi}{2}} 8 d\phi = 4\pi$$

$$\text{Along } bo: d\phi = 0, \quad \phi = \frac{\pi}{2}, \quad \int_b^o \vec{A} \cdot d\vec{l} = \int_2^0 \rho d\rho = -2$$

$$\text{Hence, } \oint \vec{A} \cdot d\vec{l} = \underline{\underline{4\pi - 2}}$$

(b)

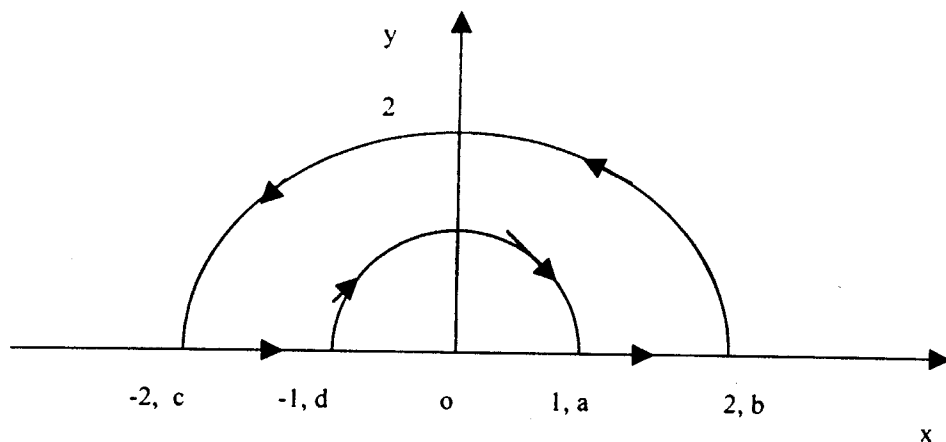

$$\text{Along } ab, \quad d\phi = 0, \quad \phi = 0, \quad \vec{A} \cdot d\vec{l} = 0, \quad \int_a^b \vec{A} \cdot d\vec{l} = 0.$$

$$\text{Along } bc, \quad d\rho = 0, \quad \vec{A} \cdot d\vec{l} = \rho^3 d\phi,$$

$$\int_b^c \vec{A} \cdot d\vec{l} = \int_0^\pi \rho^3 d\phi = (2)^3 (\pi - 0) = 8\pi$$

$$\text{Along } cd, \quad d\phi = 0, \quad \phi = \pi, \quad \vec{A} \cdot d\vec{l} = 0, \quad \int_c^d \vec{A} \cdot d\vec{l} = 0$$

$$\text{Along } da, \quad d\rho = 0, \quad \vec{A} \cdot d\vec{l} = \rho^3 d\phi,$$

$$\int_d^a \vec{A} \cdot d\vec{l} = \rho^3 \int_\pi^0 d\phi = (1)^3 (0 - \pi) = -\pi.$$

$$\text{Hence, } \oint \vec{A} \cdot d\vec{l} = 0 + 8\pi + 0 - \pi = \underline{\underline{7\pi}}.$$

This may be checked by using Stokes' theorem.

Prob. 3.38

$$\text{Let } \psi = \oint \vec{F} \cdot d\vec{S} = \psi_t + \psi_b + \psi_o + \psi_i$$

where $\psi_t, \psi_b, \psi_o, \psi_i$ are the fluxes through the top surface, bottom surface, outer surface ($\rho = 3$), and inner surface respectively.

For the top surface, $d\vec{S} = \rho d\phi d\rho \vec{a}_z$, $z = 5$;

$$\vec{F} \cdot d\vec{S} = \rho^2 z d\phi dz. \text{ Hence:}$$

$$\psi_t = \int_{\rho=2}^3 \int_{\phi=0}^{2\pi} \rho^2 z d\phi dz \Big|_{z=5} = \frac{190 \pi}{3}$$

For the bottom surface, $z = 0$, $d\vec{S} = \rho d\phi d\rho (-\vec{a}_z)$

$$\vec{F} \cdot d\vec{S} = \rho^2 z d\phi d\rho = 0. \text{ Hence, } \psi_b = 0.$$

For the outer curved surface, $\rho = 3$, $d\vec{S} = \rho d\phi dz \vec{a}_\rho$

$$\vec{F} \cdot d\vec{S} = \rho^3 \sin\phi d\phi dz. \text{ Hence,}$$

$$\psi_o = \int_{z=0}^5 dz \rho^3 \int_{\phi=0}^{2\pi} \sin\phi d\phi \Big|_{\rho=3} = 0$$

For the inner curved surface, $\rho = 2$, $d\vec{S} = \rho d\phi dz (-\vec{a}_\rho)$

$$\vec{F} \cdot d\vec{S} = \rho^3 \sin\phi d\phi dz. \text{ Hence,}$$

$$\psi_i = \int_{z=0}^5 dz \rho^3 \int_{\phi=0}^{2\pi} \sin\phi d\phi \Big|_{\rho=2} = 0$$

$$\psi = \frac{190 \pi}{3} + 0 + 0 + 0 = \underline{\underline{\frac{190 \pi}{3}}}$$

$$\psi = \oint \vec{F} \cdot d\vec{S} = \int \nabla \cdot \vec{F} dV$$

$$\begin{aligned} \nabla \cdot \vec{F} &= \frac{1}{\rho} \frac{\partial}{\partial \rho} (\rho^3 \sin\phi) + \frac{1}{\rho} \frac{\partial}{\partial \phi} (z \cos\phi) + \rho \\ &= 3\rho \sin\phi - \frac{z}{\rho} \sin\phi + \rho \end{aligned}$$

$$\begin{aligned}
 \int_V \nabla \cdot \bar{F} dv &= \iiint (3\rho \sin \phi - \frac{z}{\rho} \sin \phi + \rho) \rho d\phi d\rho dz \\
 &= 0 + 0 + \int_0^5 dz \int_0^{2\pi} d\phi \int_2^3 \rho^2 d\rho \\
 &= \frac{190 \pi}{3}
 \end{aligned}$$

Prob. 3.39

$$\text{Let } \bar{B} = \nabla \times \bar{T}$$

$$\psi = \oint_S \bar{B} \cdot d\bar{S} = \int_V \nabla \cdot \bar{B} dv = \int_V \nabla \cdot \nabla \times \bar{T} dv = 0$$

Prob 3.40

$$\begin{aligned}
 \bar{Q} &= \frac{r}{\sin \theta} r \sin \theta [(\cos \phi - \sin \phi) \bar{a}_x + (\cos \phi + \sin \phi) \bar{a}_y] \\
 &= r(\cos \phi - \sin \phi) \bar{a}_x + r(\cos \phi + \sin \phi) \bar{a}_y
 \end{aligned}$$

$$\begin{bmatrix} Q_r \\ Q_\theta \\ Q_\phi \end{bmatrix} = \begin{bmatrix} \sin \theta \cos \phi & \sin \theta \sin \phi & \cos \theta \\ \cos \theta \cos \phi & \cos \theta \sin \phi & -\sin \theta \\ -\sin \phi & \cos \phi & 0 \end{bmatrix} \begin{bmatrix} Q_x \\ Q_y \\ Q_z \end{bmatrix}$$

$$\bar{Q} = r \sin \theta \bar{a}_r + r \cos \theta \bar{a}_\theta + r \bar{a}_\phi$$

(a)

$$d\bar{l} = \rho d\phi \bar{a}_\phi, \quad \rho = r \sin 30^\circ = 2\left(\frac{1}{2}\right) = 1$$

$$z = r \cos 30^\circ = \sqrt{3}$$

$$Q_\phi = r = \sqrt{\rho^2 + z^2}$$

$$\oint \bar{Q} \cdot d\bar{l} = \int_0^{2\pi} \sqrt{\rho^2 + z^2} \rho d\phi = 2(1)(2\pi) = \underline{4\pi}$$

(b)

$$\nabla \times \bar{Q} = \cot \theta \bar{a}_r - 2\bar{a}_\theta + \cos \theta \bar{a}_\phi$$

$$\text{For } S_1, \quad d\bar{S} = r^2 \sin \theta d\theta d\phi \bar{a}_r$$

$$\int_{S_1} (\nabla \times \bar{Q}) \cdot d\bar{S} = \int r^2 \sin \theta \cot \theta d\theta d\phi \Big|_{r=2}$$

$$= 4 \int_0^{2\pi} d\phi \int_0^{30^\circ} \cos \theta d\theta = \underline{4\pi}$$

(c)

$$\text{For } S_2, \quad d\bar{S} = r \sin\theta d\theta dr \bar{a}_\theta$$

$$\int_{S_2} (\nabla \times \bar{Q}) \cdot d\bar{S} = -2 \int r \sin\theta d\phi dr \Big|_{\theta=30^\circ}$$

$$= -2 \sin 30 \int_0^2 r dr \int_0^{2\pi} d\phi$$

$$= \underline{\underline{-4\pi}}$$

(d)

$$\text{For } S_1, \quad d\bar{S} = r^2 \sin\theta d\phi d\theta \bar{a}_r$$

$$\int_{S_1} \bar{Q} \cdot d\bar{S} = r^3 \int \sin^2\theta d\theta d\phi \Big|_{r=2}$$

$$= 8 \int_0^{2\pi} d\phi \int_0^{30^\circ} \sin^2\theta d\theta$$

$$= \underline{\underline{4\pi \left[\frac{\pi}{3} - \frac{\sqrt{3}}{2} \right]}}$$

(e)

$$\text{For } S_2, \quad d\bar{S} = r \sin\theta d\phi dr \bar{a}_\theta$$

$$\int_{S_2} \bar{Q} \cdot d\bar{S} = \int r^2 \sin\theta \cos\theta d\phi dr \Big|_{\theta=30^\circ}$$

$$= \underline{\underline{\frac{4\pi\sqrt{3}}{3}}}$$

(f)

$$\nabla \cdot \bar{Q} = \frac{1}{r^2} \frac{\partial}{\partial r} (r^3 \sin\theta) + \frac{r}{r \sin\theta} \frac{\partial}{\partial \theta} (\sin\theta \cos\theta) + 0$$

$$= 2 \sin\theta + \cos\theta \cot\theta$$

$$\int \nabla \cdot \bar{Q} dV = \int (2 \sin\theta + \cos\theta \cot\theta) r^2 \sin\theta d\theta d\phi dr$$

$$= \frac{r^3}{3} \Big|_0^2 (2\pi) \int_0^{30^\circ} (1 + \sin^2\theta) d\theta$$

$$= \underline{\underline{\frac{4\pi}{3} \left(\pi - \frac{\sqrt{3}}{2} \right)}}$$

$$\begin{aligned}
 \text{Check: } \int \nabla \cdot \bar{Q} dV &= \left(\int_{S_1} + \int_{S_2} \right) (\nabla \times \bar{Q}) \cdot d\bar{S} \\
 &= 4\pi \left[\frac{\pi}{3} - \frac{\sqrt{3}}{2} + \frac{\sqrt{3}}{3} \right] \\
 &= \frac{4\pi}{3} \left[\pi - \frac{\sqrt{3}}{2} \right] \quad (\text{It checks.})
 \end{aligned}$$

Prob. 3.41

Since $\bar{u} = \bar{\omega} \times \bar{r}$, $\nabla \times \bar{u} = \nabla \times (\bar{\omega} \times \bar{r})$. From Appendix A.10,

$$\nabla \times (\bar{A} \times \bar{B}) = \bar{A}(\nabla \cdot \bar{B}) - \bar{B}(\nabla \cdot \bar{A}) + (\bar{B} \cdot \nabla)\bar{A} - (\bar{A} \cdot \nabla)\bar{B}$$

$$\nabla \times \bar{u} = \nabla \times (\bar{\omega} \times \bar{r})$$

$$\begin{aligned}
 \nabla \times (\bar{\omega} \times \bar{r}) &= \bar{\omega}(\nabla \cdot \bar{r}) - \bar{r}(\nabla \cdot \bar{\omega}) + (\bar{r} \cdot \nabla)\bar{\omega} - (\bar{\omega} \cdot \nabla)\bar{r} \\
 &= \bar{\omega}(3) - \bar{\omega} = 2\bar{\omega}
 \end{aligned}$$

$$\text{or } \bar{\omega} = \frac{1}{2} \nabla \times \bar{u}.$$

Alternatively, let $x = r \cos \omega t$, $y = r \sin \omega t$

$$\begin{aligned}
 \bar{u} &= \frac{\partial x}{\partial t} \bar{a}_x + \frac{\partial y}{\partial t} \bar{a}_y \\
 &= -\omega r \sin \omega t \bar{a}_x + \omega r \cos \omega t \bar{a}_y \\
 &= -\omega y \bar{a}_x + \omega x \bar{a}_y \\
 \nabla \times \bar{u} &= \begin{vmatrix} \frac{\partial}{\partial x} & \frac{\partial}{\partial y} & \frac{\partial}{\partial z} \\ -\omega y & \omega x & 0 \end{vmatrix} = 2\omega \bar{a}_z = 2\omega \\
 \text{i.e., } \bar{\omega} &= \frac{1}{2} \nabla \times \bar{u}
 \end{aligned}$$

Prob 3.42

Let $\bar{A} = U \nabla V$ and apply Stokes' theorem.

$$\begin{aligned}
 \int_l U \nabla V \cdot d\bar{l} &= \int \nabla X(U \nabla V) \cdot d\bar{S} \\
 &= \int (\nabla U X \nabla V) dS + \int U (\nabla X \nabla V) \cdot d\bar{S}
 \end{aligned}$$

But $\nabla X \nabla V = 0$. Hence,

$$\int_L \nabla U \cdot d\bar{l} = \int_S (\nabla U \times \nabla V) \cdot d\bar{S}$$

Similarly, we can show that

$$\int_L \nabla V \cdot d\bar{l} = \int_S (\nabla V \times \nabla U) \cdot d\bar{S} - \int_S (\nabla U \times \nabla V) \cdot d\bar{S}$$

$$\text{Thus, } \underline{\underline{\int_L \nabla V \cdot d\bar{l} = - \int_L \nabla U \cdot d\bar{l}}}$$

Prob. 3.43

$$\text{Let } \bar{A} = r^n \bar{r} = (x^2 + y^2 + z^2)^{n/2} (x\bar{a}_x + y\bar{a}_y + z\bar{a}_z)$$

By divergence theorem,

$$\int \bar{A} \cdot d\bar{S} = \int \nabla \cdot \bar{A} \, dv$$

$$\begin{aligned} \nabla \cdot \bar{A} &= \frac{\partial Ax}{\partial x} + \frac{\partial Ay}{\partial y} + \frac{\partial Az}{\partial z} \\ &= \frac{\partial}{\partial x} (xr^n) + \frac{\partial}{\partial y} (yr^n) + \frac{\partial}{\partial z} (zr^n) \\ &= r^n + 2x^2 \left(\frac{n}{2}\right) (x^2 + y^2 + z^2)^{n/2-1} \\ &\quad + r^n + 2y^2 \left(\frac{n}{2}\right) (x^2 + y^2 + z^2)^{n/2-1} \\ &\quad + r^n + 2z^2 \left(\frac{n}{2}\right) (x^2 + y^2 + z^2)^{n/2-1} \\ &= 3r^n + n(x^2 + y^2 + z^2)r^{n-1} \\ &= (3+n)r^n \end{aligned}$$

$$\text{Thus, } \oint r^n \bar{r} \, d\bar{s} = \int (3+n)r^n \, dV$$

$$\text{or } \underline{\underline{\int r^n \, dv = \frac{1}{n+3} \oint r^n \bar{r} \, d\bar{s}}}$$

Prob 3.44

(a)

$$\nabla \times \bar{G} = \begin{vmatrix} \frac{\partial}{\partial x} & \frac{\partial}{\partial y} & \frac{\partial}{\partial z} \\ 16xy - z & 8x^2 & -x \end{vmatrix}$$

$$= 0\bar{a}_x + (-1+1)\bar{a}_y + (16x-16x)\bar{a}_z = 0$$

Thus, G is irrotational.

(b)

$$4 = \oint \bar{G} \cdot d\bar{s} = \int \nabla \cdot \bar{G} dv$$

$$\nabla \cdot \bar{G} = 16y + 0 + 0 = 16y$$

$$4 = \iiint 16y dx dy dz = 16 \int_0^1 dx \int_0^1 dz \int_0^1 y dy = 16(1)(1) \left(\frac{y^2}{2} \Big|_0^1 \right) = \underline{\underline{8}}$$

(c)

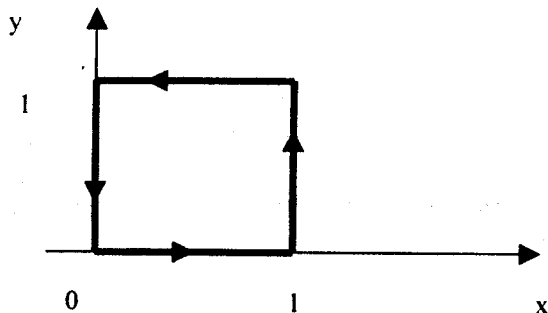

$$\begin{aligned} \oint_L \bar{G} \cdot d\bar{l} &= \int_{x=0}^{x=1} (16xy - z) dx \Big|_{z=0}^{y=0} + \int_{y=0}^{y=1} 8x^2 dy \Big|_{z=0}^{x=1} + \int_{x=1}^{x=0} (16xy - z) dx \Big|_{z=0}^{y=1} + \int_{y=1}^{y=0} 8x^2 dy \Big|_{z=0}^{x=0} \\ &= 0 + 8(1)y \Big|_0^1 + 16(1) \frac{x^2}{2} \Big|_1^0 + 0 \\ &= 8 - 8 = \underline{\underline{0}} \end{aligned}$$

This is expected since \bar{G} is irrotational, i.e.

$$\oint \bar{G} \cdot d\bar{l} = \int (\nabla \times \bar{G}) \cdot d\bar{S} = 0$$

Prob 3.45

$$\begin{aligned} \nabla \times \bar{T} &= \begin{vmatrix} \frac{\partial}{\partial x} & \frac{\partial}{\partial y} & \frac{\partial}{\partial z} \\ \alpha x + \beta z^2 & 3x^2 - \gamma z & 3xz^2 - y \end{vmatrix} \\ &= (-1 + \gamma) \bar{a}_x + (3\beta z^2 - 3z^2) \bar{a}_y + (6x - \alpha x) \bar{a}_z \end{aligned}$$

If \bar{T} is irrotational, $\nabla \times \bar{T} = 0$, i.e.

$$\underline{\underline{\alpha = 1 = \beta = \gamma}}$$

$$\nabla \cdot \vec{T} = \frac{\partial \bar{T}_x}{\partial x} + \frac{\partial \bar{T}_y}{\partial y} + \frac{\partial \bar{T}_z}{\partial z} = \alpha y + 0 + 6xz$$

At $(2, -1, 0)$,

$$\nabla \cdot \vec{T} = -1 + 0 = \underline{\underline{-1}}$$

CHAPTER 4

P. E. 4.1

$$(a) \vec{F} = \frac{1 \times 10^{-9}}{4\pi \left(\frac{10^{-9}}{36\pi}\right)} \left[\frac{5 \times 10^{-9} [(1, -3, 7) - (2, 0, 4)]}{[(1, -3, 7) - (2, 0, 4)]^3} \right. \\ \left. - \frac{2 \times 10^{-9} [(1, -3, 7) - (-3, 0, 5)]}{[(1, -3, 7) - (-3, 0, 5)]^3} \right] \\ = \left[\frac{45(-1, -3, 3)}{19^{3/2}} - \frac{18(4, -3, 2)}{29^{3/2}} \right] \text{ nN}$$

$$(a) = \underline{\underline{-1.004\bar{a}_x - 1.284\bar{a}_y + 1.4\bar{a}_z \text{ nN}}}$$

$$(b) \vec{E} = \frac{\vec{F}}{Q} = \underline{\underline{-1.004\bar{a}_x - 1.284\bar{a}_y + 1.4\bar{a}_z \text{ V/m}}}$$

P. E. 4.2

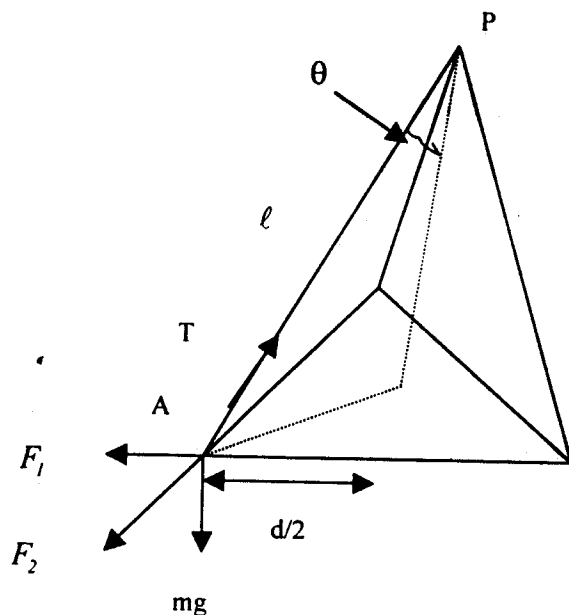

At point A,

$$T \sin \theta \cos 30^\circ = F_1 + F_2 \cos 60^\circ \\ = \frac{q^2}{4\pi\epsilon_0 d^2} + \frac{q^2}{4\pi\epsilon_0 d^2} \left(\frac{1}{2}\right) \\ = \frac{3q^2}{8\pi\epsilon_0 d^2}$$

$$T \cos \theta = mg$$

$$\text{Hence, } \tan\theta \cos 30^\circ = \frac{3q^2}{8\pi\epsilon_0 d^2} mg$$

$$\text{But } \sin\theta = \frac{h}{l} = \frac{d}{\sqrt{3}l} \tan\theta = \frac{\frac{d}{\sqrt{3}}}{\sqrt{l^2 - \frac{d^2}{3}}}$$

$$\text{Thus, } \frac{\frac{d}{\sqrt{3}} \left(\frac{\sqrt{3}}{2}\right)}{\sqrt{l^2 - \frac{d^2}{3}}} = \frac{3q^2}{8\pi\epsilon_0 d^2 mg}$$

$$\text{or } q^2 = \frac{4\pi\epsilon_0 d^3 mg}{3\sqrt{l^2 - \frac{d^2}{3}}}$$

$$\text{but } q = \frac{Q}{3} \longrightarrow q^2 = \frac{Q^2}{9}. \text{ Hence,}$$

$$Q^2 = \frac{12\pi\epsilon_0 d^3 mg}{\sqrt{l^2 - \frac{d^2}{3}}}$$

P.E. 4.3

$$e\bar{E} = m \frac{d^2 \bar{l}}{dt^2}$$

$$eE_0(-2\bar{a}_x + \bar{a}_y) = m\left(\frac{d^2 x}{dt^2} \bar{a}_x + \frac{d^2 y}{dt^2} \bar{a}_y + \frac{d^2 z}{dt^2} \bar{a}_z\right)$$

$$\text{where } E_0 = 200 \text{ kV/m}$$

$$\frac{d^2 z}{dt^2} = 0 \longrightarrow z = ct + c_2$$

$$m \frac{d^2 x}{dt^2} = -2eE_0 \longrightarrow x = \frac{-2eE_0 t^2}{2m} + c_3 t + c_4$$

$$m \frac{d^2 y}{dt^2} = eE_0 \longrightarrow y = \frac{eE_0 t^2}{2m} + c_5 t + c_6$$

At $t = 0$, $(x, y, z) = (0, 0, 0)$ $c_1 = 0 = c_4 = c_6$

Also, $(\frac{dx}{dt}, \frac{dy}{dt}, \frac{dz}{dt}) = (0, 0, 0)$

At $t = 0 \longrightarrow c_1 = 0 = c_3 = c_5$

Hence, $(x, y) = \frac{eE_0 t^2}{2m} (-2, 1)$

i.e. $2|y| = |x|$

Thus the largest horizontal distance is

$$80 \text{ cm} = \underline{\underline{0.8 \text{ m}}}$$

P.E. 4.4

(a)

Consider an element of area ds of the disk.

The contribution due to $ds = \rho d\phi d\rho$ is

$$dE = \frac{\rho_s ds}{4\pi\epsilon_0 r^2} = \frac{\rho_s ds}{4\pi\epsilon_0 (\rho^2 + h^2)}$$

The sum of the contribution along ρ gives zero.

$$\begin{aligned} E_z &= \frac{\rho_s}{4\pi\epsilon_0} \int_{\rho=0}^a \int_{\phi=0}^{2\pi} \frac{z \rho d\rho d\phi}{(\rho^2 + h^2)^{3/2}} = \frac{h\rho_s}{2\epsilon_0} \int_{\rho=0}^a \frac{\rho d\rho}{(\rho^2 + h^2)^{3/2}} \\ &= \frac{h\rho_s}{4\epsilon_0} \int_0^a (\rho^2 + h^2)^{-3/2} d(\rho^2) = \frac{h\rho_s}{2\epsilon_0} (-2(\rho^2 + h^2)^{-1/2}) \Big|_0^a \\ &= \frac{\rho_s}{2\epsilon_0} \left[1 - \frac{h}{(h^2 + a^2)^{1/2}} \right] \end{aligned}$$

(b)

As $a \longrightarrow \infty$,

$$\underline{\underline{\bar{E} = \frac{\rho_s}{2\epsilon_0} \bar{a}_z}}$$

P.E. 4.5

$$\begin{aligned} Q_S &= \int \rho_s dS = \int_{-2}^2 \int_{-2}^2 12|y| dx dy \\ &= 12(4) \int_0^2 2y dy = \underline{\underline{192 \text{ mC}}} \end{aligned}$$

$$\bar{E} = \int \frac{\rho_s dS}{4\pi\epsilon_0 r^2} \bar{a}_r = \int \frac{\rho_s dS}{4\pi\epsilon_0} \frac{\bar{r} - \bar{r}'}{|\bar{r} - \bar{r}'|^3}$$

where $\bar{r} - \bar{r}' = (0,0,10) - (x,y,z) = (-x,-y,10)$.

$$\begin{aligned}\bar{E} &= \int_{x=-2}^2 \int_{y=-2}^2 \frac{12|y|10^{-3}(-x,-y,10)}{4\pi\left(\frac{10^{-9}}{36\pi}\right)(x^2+y^2+100)^{3/2}} \\ &= 108(10^{-6}) \left[\int_{-2}^2 |y| \int_{-2}^2 \frac{-x dx dy \bar{a}_x}{(x^2+y^2+100)^{3/2}} + \int_{-2}^2 |y| \int_{-2}^2 \frac{-y|y| dy dx \bar{a}_y}{(x^2+y^2+100)^{3/2}} \right. \\ &\quad \left. + 10\bar{a}_z \int_{-2}^2 \int_{-2}^2 \frac{-|y| dx dy}{(x^2+y^2+100)^{3/2}} \right]\end{aligned}$$

$$\begin{aligned}\bar{E} &= 108(10^7)\bar{a}_z \int_{-2}^2 \left[2 \int_0^2 \frac{\frac{1}{2}d(y^2)}{(x^2+y^2+100)^{3/2}} \right] dx \\ &= -216(10^7)\bar{a}_z \int_{-2}^2 \left[\frac{1}{(x^2+104)^{1/2}} - \frac{1}{(x^2+100)^{1/2}} \right] dx \\ &= -216(10^7)\bar{a}_z \ln \left| \frac{x+\sqrt{x^2+104}}{x+\sqrt{x^2+100}} \right|_{-2}^2 \\ &= -216(10^7)\bar{a}_z \left(\ln \left(\frac{2+\sqrt{108}}{2+\sqrt{104}} \right) - \ln \left(\frac{-2+\sqrt{108}}{-2+\sqrt{104}} \right) \right) \\ &= -216(10^7)\bar{a}_z (-7.6202(10^{-3}))\end{aligned}$$

$$\bar{E} = \underline{\underline{16.46 \bar{a}_z \text{ mV/m}}}$$

P.E. 4.6

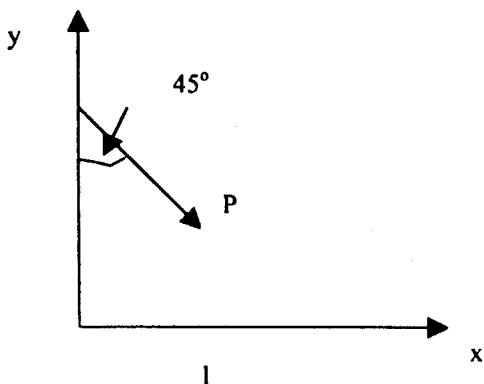

$$\bar{E} = \frac{\rho_l}{2\pi\epsilon_0\rho} \bar{a}_\rho$$

To get \bar{a}_ρ , consider the $z = -l$ plane. $\rho = \sqrt{2}$

$$\bar{a}_\rho = \bar{a}_x \cos 45^\circ - \bar{a}_y \sin 45^\circ$$

$$= \frac{1}{\sqrt{2}}(\bar{a}_x - \bar{a}_y)$$

$$\bar{E}_3 = \frac{10(10^{-9})}{2\pi\left(\frac{10^{-9}}{36\pi}\right)} \frac{1}{2}(\bar{a}_x - \bar{a}_y)$$

$$= 90\pi(\bar{a}_x - \bar{a}_y). \quad \text{Hence,}$$

$$\bar{E} = \bar{E}_1 + \bar{E}_2 + \bar{E}_3$$

$$= -180\pi\bar{a}_x + 270\pi\bar{a}_y + 90\pi\bar{a}_x - 90\pi\bar{a}_y.$$

$$= \underline{\underline{-282.7\bar{a}_x + 565.5\bar{a}_y \text{ V/m}}}$$

P.E. 4.7

$$\begin{aligned} \bar{D} &= \bar{D}_Q + \bar{D}_\rho = \frac{Q}{4\pi r^2} \bar{a}_r + \frac{\rho_s}{2} \bar{a}_n \\ &= \frac{30 \times 10^{-9}}{4\pi(5)^2} \frac{[(0,4,3) - (0,0,0)]}{5} + \frac{10 \times 10^{-9}}{2} \bar{a}_y \\ &= \frac{30}{500\pi} (0,4,3) + 5\bar{a}_y \text{ nC/m}^2 \\ &= \underline{\underline{5.076\bar{a}_y + 0.0573\bar{a}_z \text{ nC/m}^2}} \end{aligned}$$

P.E. 4.8

$$(a) \rho v = \nabla \cdot \bar{D} = 4x$$

$$\rho v(-1,0,3) = \underline{\underline{-4 \text{ C/m}^3}}$$

$$(b) 4 = Q = \int \rho v dv = \int_0^1 \int_0^1 \int_0^1 4x dx dy dz$$

$$= 4(1)(1)(1/2) = \underline{\underline{2 \text{ C}}}$$

$$(c) Q = 4 = \underline{\underline{2 \text{ C}}}$$

P.E. 4.9

$$Q = \int \rho v dv = \psi = \oint \bar{D} \cdot d\bar{s}$$

For $0 \leq r \leq 10$,

$$D_r(4\pi r^2) = \iiint 2r(r^2) \sin\theta \, d\theta \, dr \, d\phi$$

$$D_r(4\pi r^2) = 4\pi \left(\frac{2r^4}{4} \right) \Big|_0^r = 2\pi r^4$$

$$D_r = \frac{r^2}{2} \quad \bar{E} = \frac{r^2}{2\epsilon_0} \bar{a}_r \text{ nV/m}$$

$$\bar{E}(r=2) = \frac{4(10^{-9})}{2\left(\frac{10^{-9}}{36\pi}\right)} \bar{a}_r = 72\pi \bar{a}_r = \underline{\underline{226 \bar{a}_r \text{ V/m}}}$$

For $r \leq 10$,

$$D_r(4\pi r^2) = 2\pi r_0^4, \quad r_0 = 10\text{m}$$

$$D_r = \frac{r_0^4}{2r^2} \quad \longrightarrow \quad \bar{E} = \frac{r_0^4}{2\epsilon_0 r^2} \bar{a}_r \text{ nV/m}$$

$$\begin{aligned} \bar{E}(r=12) &= \frac{10^4(10^{-9})}{2\left(\frac{10^{-9}}{36\pi}\right)(144)} \bar{a}_r = 1250\pi \bar{a}_r \\ &= \underline{\underline{3.927 \bar{a}_r \text{ kV/m}}} \end{aligned}$$

P. E. 4.10

$$V(\bar{r}) = \sum_{k=1}^3 \frac{Q_k}{4\pi\epsilon_0 |\bar{r} - \bar{r}_k|} + C$$

At $V(\infty) = 0$, $C = 0$

$$|\bar{r} - \bar{r}_1| = |(-1, 5, 2) - (2, -1, 3)| = \sqrt{46}$$

$$|\bar{r} - \bar{r}_2| = |(-1, 5, 2) - (0, 4, -2)| = \sqrt{18}$$

$$|\bar{r} - \bar{r}_3| = |(-1, 5, 2) - (0, 0, 0)| = \sqrt{30}$$

$$\begin{aligned} V(-1, 5, 2) &= \frac{10^{-6}}{4\pi\left(\frac{10^{-9}}{36\pi}\right)} \left[\frac{-4}{\sqrt{46}} + \frac{5}{\sqrt{18}} + \frac{3}{\sqrt{30}} \right] \\ &= \underline{\underline{10.3 \text{ kV}}} \end{aligned}$$

P.E. 4.11

$$V = \frac{Q}{4\pi\epsilon_0 r} + C$$

$$\text{If } V(0,6,-8) = V(r=10) = 2;$$

$$2 = \frac{5(10^{-9})}{4\pi\left(\frac{10^{-9}}{36\pi}\right)} + C \quad \longrightarrow \quad C = -2.5$$

(a)

$$\begin{aligned} V_A &= \frac{5(10^{-9})}{4\pi\left(\frac{10^{-9}}{36\pi}\right)|(-3,2,6) - (0,0,0)|} - 2.5 \\ &= \underline{\underline{3.929 V}} \end{aligned}$$

(b)

$$V_B = \frac{45}{\sqrt{1^2 + 1^2 + 5^2}} - 2.5 = \underline{\underline{2.696 V}}$$

$$(b) \quad V_{AB} = V_B - V_A = 2.696 - 3.929 = \underline{\underline{-1.233 V}}$$

P.E. 4.12

(a)

$$\begin{aligned} \frac{-W}{Q} &= \int \vec{E} \cdot d\vec{l} = \int (3x^2 + y)dx + xdy \\ &= \int_0^2 (3x^2 + y)dx \Big|_{y=5} + \int_5^{-1} x dy \Big|_{x=2} \\ &= 18 - 12 = 6 \end{aligned}$$

$$W = -6Q = \underline{\underline{12 \text{ mJ}}}$$

(b)

$$dy = -3 dx$$

$$\begin{aligned} \frac{-W}{Q} &= \int \vec{E} \cdot d\vec{l} = \int_0^2 (3x^2 + 5 - 3x)dx + x(-3)dx \\ &= \int_0^2 (3x^2 - 6x + 5)dx = 8 - 12 + 10 = 6 \end{aligned}$$

$$W = \underline{\underline{12 \text{ nJ}}}$$

P.E. 4.13

(a)

$$(0,0,10) \longrightarrow (r = 10, \theta = 0, \phi = 0)$$

$$V = \frac{100 \cos 0}{4\pi\epsilon_0(10)} (10^{-12}) = \frac{10^{-12}}{4\pi\left(\frac{10^{-9}}{36\pi}\right)} = \underline{\underline{9 \text{ mV}}}$$

$$\vec{E} = \frac{100(10^{-12})}{4\pi\left(\frac{10^{-9}}{36\pi}\right)10^3} [2 \cos 0 \bar{a}_r + \sin 0 \bar{a}_\theta]$$

$$= \underline{\underline{1.8 \bar{a}_r \text{ mV/m}}}$$

(b)

$$\text{At } \left(1, \frac{\pi}{3}, \frac{\pi}{2}\right),$$

$$V = \frac{100 \cos \frac{\pi}{3} (10^{-12})}{4\pi\left(\frac{10^{-9}}{36\pi}\right)(1)^2} = \underline{\underline{0.45 \text{ V}}}$$

$$\vec{E} = \frac{100(10^{-12})}{4\pi\left(\frac{10^{-9}}{36\pi}\right)(1)^2} \left(2 \cos \frac{\pi}{3} \bar{a}_r + \sin \frac{\pi}{3} \bar{a}_\theta\right)$$

$$= \underline{\underline{0.9 \bar{a}_r + 0.7794 \bar{a}_\theta \text{ V/m}}}$$

P.E. 4.14After Q_1 , $W_1 = 0$

$$\begin{aligned} \text{After } Q_2, W_2 &= Q_2 V_{21} = \frac{Q_2 Q_1}{4\pi\epsilon_0 |(1,0,0) - (0,0,0)|} \\ &= \frac{1(-2)(10^{-18})}{4\pi(10^{-9}) \frac{1}{36\pi}} = \underline{\underline{-18 \text{ nJ}}} \end{aligned}$$

After Q_3 ,

$$\begin{aligned} W_3 &= Q_3(V_{31} + V_{32}) + Q_2 V_{21} \\ &= 3(9)(10^{-9}) \left\{ \frac{1}{|(0,0,-1) - (0,0,0)|} + \frac{-2}{|(0,0,-1) - (1,0,0)|} \right\} - 18 \text{ nJ} \\ &= 27\left(1 - \frac{2}{\sqrt{2}}\right) - 18 \\ &= \underline{\underline{-29.18 \text{ nJ}}} \end{aligned}$$

P.E. 4.15After Q_1 ,

$$\begin{aligned}
 W_4 &= Q_4(V_{41} + V_{42} + V_{43}) + Q_3(V_{31} + V_{32}) + Q_2V_{21} \\
 &= -4(9)(10^{-9}) \left\{ \frac{1}{|(0,0,1) - (0,0,0)|} + \frac{-2}{|(0,0,1) - (1,0,0)|} + \frac{3}{|(0,0,1) - (0,0,-1)|} \right\} + W_3 \\
 &= -36 \left(1 - \frac{2}{\sqrt{2}} + \frac{3}{2} \right) + W_3 \\
 &= -39.09 - 29.18 \text{ nJ} = \underline{\underline{-68.27 \text{ nJ}}}
 \end{aligned}$$

Prob. 4.1

(a)

$$\begin{aligned}
 \bar{F}_{Q_1} &= \frac{Q_1 Q_2 (\bar{r}_{Q_1} - \bar{r}_{Q_2})}{4\pi \epsilon \left| \bar{r}_{Q_1} - \bar{r}_{Q_2} \right|^3} = \frac{-20(10^{-12})[(3,2,1) - (-4,0,0)]}{4\pi \frac{10^{-9}}{36\pi} |(3,2,1) - (-4,0,0)|^3} = -0.5655 \frac{(7,2,5)}{688.88} \\
 &= \underline{\underline{-5.746 \bar{a}_x - 1.642 \bar{a}_y + 4.104 \bar{a}_z \text{ mN}}}
 \end{aligned}$$

Prob 4.2

(a)

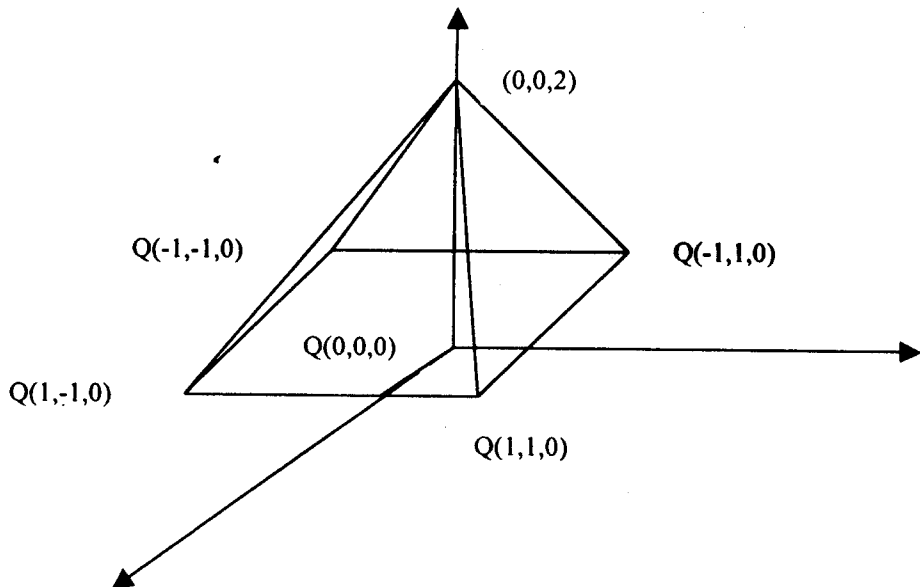

$$\bar{F} = \frac{qQ}{4\pi\epsilon_0} \frac{[(0,0,2)-(0,0,0)]}{|(0,0,2)-(0,0,0)|^3} + \frac{qQ}{4\pi\epsilon_0} \frac{[(0,0,2)-(1,1,0)]}{|(0,0,2)-(1,1,0)|^3} + \frac{qQ}{4\pi\epsilon_0} \frac{[(0,0,2)-(-1,1,0)]}{|(0,0,2)-(-1,1,0)|^3} \\ + \frac{qQ}{4\pi\epsilon_0} \frac{[(0,0,2)-(1,-1,0)]}{|(0,0,2)-(1,-1,0)|^3} + \frac{qQ}{4\pi\epsilon_0} \frac{[(0,0,2)-(-1,-1,0)]}{|(0,0,2)-(-1,-1,0)|^3}$$

$$\text{But } \frac{qQ}{4\pi\epsilon_0} = \frac{15(10)(10^{-12})}{4\pi(10^{-9}/36\pi)} = 1.35$$

Factoring and dividing by 1.35 yields

$$\frac{\bar{F}}{1.35} = \frac{(0,0,2)}{8} + \frac{(-1,-1,2)}{6^{3/2}} + \frac{(1,-1,2)}{6^{3/2}} + \frac{(-1,1,2)}{6^{3/2}} + \frac{(1,1,2)}{6^{3/2}}$$

$$\bar{F} = 1.35(0.25 + \frac{8}{6^{3/2}})\bar{a}_z = \underline{\underline{1.072 \bar{a}_z N}}$$

(b)

$$\bar{E} = \frac{\bar{F}}{q} = \frac{1.072\bar{a}_z}{10(10^{-6})} = 107.2 \bar{a}_z \text{ kV/m}$$

Prob 4.3 (a)

$$\bar{E}(5,0,6) = \frac{qQ}{4\pi\epsilon_0} \frac{[(5,4,6)-(4,0,-3)]}{|(5,4,6)-(4,0,-3)|^3} + \frac{qQ}{4\pi\epsilon_0} \frac{[(5,0,6)-(2,0,1)]}{|(5,0,6)-(2,0,1)|^3} \\ = \frac{qQ}{4\pi\epsilon_0} \frac{(1,0,9)}{(\sqrt{82})^3} + \frac{qQ}{4\pi\epsilon_0} \frac{(3,0,5)}{(61)^{3/2}}$$

If $\bar{E}_z = 0$, then

$$\frac{9qQ}{4\pi\epsilon_0} \frac{1}{(82)^{3/2}} + \frac{5qQ}{4\pi\epsilon_0} \frac{1}{(61)^{3/2}} = 0$$

$$\bar{Q}_1 = -\frac{5}{9}Q_2 \left(\frac{82}{61}\right)^{3/2} = -\frac{5}{9}4\left(\frac{82}{61}\right)^{3/2} \text{ nC} \\ = \underline{\underline{-3.463 \text{ nC}}}$$

(b)

$$\bar{F}(5,0,6) = q\bar{E}(5,0,6)$$

If $E_x = 0$, then

$$\frac{qQ_1}{4\pi\epsilon_0(82)^{3/2}} + \frac{3qQ_2}{4\pi\epsilon_0(61)^{3/2}} = 0$$

$$Q_1 = -3Q_2 \left(\frac{82}{61}\right)^{3/2} = -12\left(\frac{82}{61}\right)^{3/2} \text{ nC}$$

$$Q_1 = \underline{\underline{-18.7 \text{ nC}}}$$

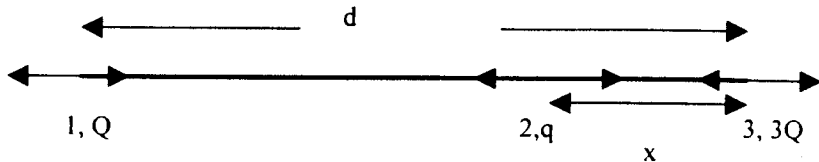
Prob 4.4

For the system to be in equilibrium, q must be negative and

$$\bar{F}_{12} = \bar{F}_{23} = \bar{F}_{13}$$

$$\text{or } \frac{-1Qq}{4\pi(d-x)^2} = \frac{-3Qq}{4\pi x^2} = \frac{4Q^2}{4\pi d^2}$$

$$\text{that is, } 3(d-x)^2 = x^2 \quad \longrightarrow \quad 3d^2 - 6dx + 3x^2 = x^2$$

$$2x^2 - 6dx + 3d^2 = 0$$

$$x = \frac{6d \pm \sqrt{36d^2 - 24d^2}}{4} = \frac{6d \pm d\sqrt{12}}{4}$$

$$x = 3 \pm \sqrt{3} = \underline{\underline{4.732\text{m}, 1.268\text{m}}}$$

Prob 4.5

$$(a) \quad Q = \int \rho_L dl = \int_0^5 2x^2 dx = 4x^3 \Big|_0^5 = \underline{\underline{0.5C}}$$

$$(b) \quad Q = \int \rho_S dS = \int_{z=0}^4 \int_{\phi=0}^{2\pi} \rho z^2 \rho d\phi dz \Big|_{\rho=3} = 9(2\pi) \frac{z^3}{3} \Big|_0^4 = \underline{\underline{1.206 \mu C}}$$

$$(c) \quad Q = \int \rho_V dV = \iiint \frac{10}{r \sin \theta} r^2 \sin \theta d\theta d\phi dr$$

$$= 10 \int_0^{2\pi} d\phi \int_0^{\pi} d\theta \int_0^4 r dr = 10(2\pi)(\pi) \frac{4^2}{2}$$

$$= \underline{\underline{157.91 C}}$$

Prob. 4.6

$$Q_A = \int \rho_L dl = \rho_L \int_{-5}^0 dl = 5\rho_L = 10 \text{ mC}$$

$$\bar{Q}_B = \int \rho_S dS = \rho_S \int dS = \rho_S \iint \rho d\phi d\rho$$

$$= \rho_S \int_0^4 \rho d\rho \int_{\phi=0}^{\pi/2} d\phi = \rho_S \frac{\rho^2}{2} \Big|_0^4 \left(\frac{\pi}{2} \right)$$

$$= \rho_S (8) \left(\frac{\pi}{2} \right) = 20\pi \text{ mC} = \underline{\underline{62.83 \text{ mC}}}$$

Prob 4.7

$$\bar{E} = \int \frac{\rho dl \bar{R}}{4\pi\epsilon_0 R^3}; \quad dl = dy; \quad \bar{R} = (5,0,0) - (0,y,0) = 5\bar{a}_x - y\bar{a}_y$$

$$\begin{aligned} \bar{E} &= \rho_l \int \frac{5\bar{a}_x - y\bar{a}_y}{4\pi\epsilon_0 (y^2 + 25)^{3/2}} \\ &= \frac{2(10^{-3})}{4\pi(10^{-9}/36\pi)} \int_0^{-5} (5\bar{a}_x + y\bar{a}_y) \frac{1}{(y^2 + 25)^{3/2}} dy \\ &= 18(10^6) [k_x \bar{a}_x + k_y \bar{a}_y] \end{aligned}$$

$$\text{where } k_x = \int_0^{-5} \frac{dy}{(y^2 + 25)^{3/2}} = \frac{5(y/25)}{\sqrt{y^2 + 25}} \Big|_0^{-5} = -\frac{1}{\sqrt{50}} = -0.1414$$

$$\text{where } k_y = \int_0^{-5} \frac{y}{(y^2 + 25)^{3/2}} dy = \frac{1}{\sqrt{y^2 + 25}} \Big|_0^{-5} = -\frac{1}{\sqrt{50}} + \frac{1}{5} = 0.05858$$

$$\bar{E} = \underline{\underline{-2.545\bar{a}_x + 1.054\bar{a}_y \text{ mV/m}}}$$

Prob. 4.8

$$\bar{E} = \int \frac{\rho dS \bar{R}}{4\pi\epsilon_0 R^3}; \quad dS = \rho d\phi dp; \quad R = \sqrt{\rho^2 + h^2}$$

$$\bar{R} = -\rho\bar{a}_\rho + h\bar{a}_z$$

$$\begin{aligned} \bar{E} &= \frac{\rho_s}{4\pi\epsilon_0} \int \frac{(-\rho\bar{a}_\rho + h\bar{a}_z)\rho d\phi dp}{(\rho^2 + h^2)^{3/2}} \\ &= \frac{5(10^{-3})}{4\pi(10^{-9}/36\pi)} \left[- \int_{\phi=0}^{\pi/2} \int_{\rho=0}^4 \frac{\rho^2 d\phi dp}{(\rho^2 + h^2)^{3/2}} \bar{a}_\rho + h \int_{\phi=0}^{\pi/4} \int_{\rho=0}^4 \frac{\rho d\phi dp}{(\rho^2 + h^2)^{3/2}} \bar{a}_z \right] \\ &= 45(10^6) \left[-\frac{\pi}{2} \int \frac{\rho^2 dp}{(\rho^2 + h^2)^{3/2}} \bar{a}_\rho + \frac{\pi h}{2} \int \frac{\rho dp}{(\rho^2 + h^2)^{3/2}} \bar{a}_z \right] \end{aligned}$$

$$\text{But } \int \frac{x^2 dx}{(x^2 + a^2)^{3/2}} = \ln\left(\frac{\sqrt{x^2 + a^2}}{a} + \frac{x}{a}\right) - \frac{x}{\sqrt{x^2 + a^2}} + C$$

$$\text{and } \int \frac{xdx}{(x^2 + a^2)} = -\frac{1}{\sqrt{x^2 + a^2}} + C$$

$$\text{Let } \bar{E} = 45 (10^2) \left[\frac{-\pi}{2} k_\rho \bar{a}_\rho + \frac{\pi}{2} h k_z \bar{a}_z \right]$$

$$k_\rho = \left[\ln\left(\frac{\sqrt{\rho^2 + h^2}}{h} + \frac{\rho}{h}\right) - \frac{\rho}{\sqrt{\rho^2 + h^2}} \right] \Big|_{\rho=0}^a = \ln 2 - \frac{4}{5} = -0.1068$$

$$k_z = \frac{-1}{\sqrt{\rho^2 + h^2}} \Big|_0^a = -\frac{1}{5} + \frac{1}{3} = 0.1338$$

$$\bar{E} = \frac{45}{4} (10^6) [0.671 \bar{a}_\rho + 2.5126 \bar{a}_z]$$

$$= \underline{\underline{7.549 \bar{a}_\rho + 28.27 \bar{a}_z \text{ mV/m}}}$$

(b)

The result is the same as that in (a) except that instead of

$$\int_{\phi=0}^{\pi/2} d\phi = \frac{\pi}{2}, \text{ we now have } \int_{\phi=0}^{\pi/2} \sin \phi d\phi = -\cos \phi \Big|_0^{\pi/2} = 1$$

That is, we replace $\pi/2$ by 1

$$\bar{E} = 45(10^6) [-k_\rho \bar{a}_\rho + h k_z \bar{a}_z]$$

$$= \underline{\underline{4.806 \bar{a}_\rho + 18 \bar{a}_z \text{ mV/m}}}$$

Prob 4.9

$$V = \int_S \frac{\rho_s dS}{4\pi\epsilon_0 r}; \quad \rho_s = \frac{l}{\rho}; \quad dS = \rho d\phi d\rho; \quad r = \sqrt{\rho^2 + h^2}$$

$$\begin{aligned} V &= \frac{l}{4\pi\epsilon_0} \iint \frac{\rho (\rho d\phi d\rho)}{(\rho^2 + h^2)^{3/2}} = \frac{l}{4\pi\epsilon_0} \int_0^{2\pi} d\phi \int_0^a \frac{\rho d\rho}{(\rho^2 + h^2)} \\ &= \frac{2\pi}{4\pi\epsilon_0} \ln(\rho + \sqrt{\rho^2 + h^2}) \Big|_{\rho=0}^a = \frac{l}{2\epsilon_0} [\ln(a + \sqrt{\rho^2 + h^2}) - \ln h] \\ &= \underline{\underline{\frac{l}{2\epsilon_0} \ln \frac{a + \sqrt{\rho^2 + h^2}}{h}}} \end{aligned}$$

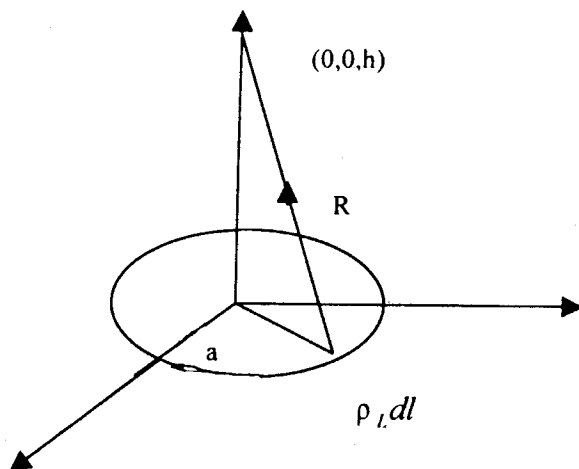
Prob. 4.10 (a)

$$\vec{D} = \int \frac{\rho_L dl \vec{R}}{4\pi R^3}, \quad \vec{R} = -a\vec{a}_\rho + h\vec{a}_z$$

$$\vec{D} = \frac{\rho_L}{4\pi} \int_{\phi=0}^{\phi=2\pi} \frac{a d\phi (-a\vec{a}_\rho + h\vec{a}_z)}{(a^2 + h^2)^{3/2}}$$

Due to symmetry, the ρ component varies.

$$\vec{D} = \frac{\rho_L a (2\pi h) \vec{a}_z}{4\pi (a^2 + h^2)^{3/2}} = \frac{\rho_L a h \vec{a}_z}{2(a^2 + h^2)^{3/2}}$$

$$a = 2, \quad h = 3, \quad \rho_L = 5 \mu\text{C/m}$$

Since the ring is placed in $x = 0$, \vec{a}_z becomes \vec{a}_x .

$$\vec{D} = \frac{2(6)(5)\vec{a}_x}{2(4+9)^{3/2}} = \underline{\underline{0.64 \vec{a}_x \mu\text{C/m}^2}}$$

(b)

$$\begin{aligned} \vec{D}_Q &= \frac{Q}{4\pi} \frac{[(3,0,0) - (0,-3,0)]}{|(3,0,0) - (0,-3,0)|^3} + \frac{Q}{4\pi} \frac{[(3,0,0) - (0,3,0)]}{|(3,0,0) - (0,3,0)|^3} \\ &= \frac{Q(3,3,0)}{4\pi(18)^{3/2}} + \frac{Q(3,-3,0)}{4\pi(18)^{3/2}} = \frac{6Q}{4\pi(18)^{3/2}} \end{aligned}$$

$$\vec{D} = \vec{D}_R + \vec{D}_Q = 0$$

$$0.64(10^{-6}) + \frac{6Q}{4\pi(18)^{3/2}} = 0$$

$$\therefore Q = -0.64(4\pi)(18^{3/2})10^{-6} \frac{1}{6} = \underline{\underline{-102.4 \mu\text{C}}}$$

Prob. 4.11

Due to symmetry, \vec{E} has only z - component given by

$$\begin{aligned} dE_z &= dE \cos \alpha \\ &= \frac{\rho_s dx dy}{4\pi\epsilon_0(x^2 + y^2 + h^2)} \frac{h}{(x^2 + y^2 + h^2)^{1/2}} \\ E_z &= \frac{\rho_s h}{4\pi\epsilon_0} \int_{-a}^a \int_{-b}^b \frac{dx dy}{(x^2 + y^2 + h^2)^{3/2}} \\ &= \frac{\rho_s h}{\pi\epsilon_0} \int_{-a}^a \int_{-b}^b \frac{dx dy}{(x^2 + y^2 + h^2)^{3/2}} \\ &= \frac{\rho_s h}{\pi\epsilon_0} \int_0^a \frac{y dx}{(x^2 + h^2)(x^2 + y^2 + h^2)^{1/2}} \Big|_0^b \\ &= \frac{\rho_s h}{\pi\epsilon_0} \int_0^a \frac{b dx}{(x^2 + h^2)(x^2 + b^2 + h^2)^{1/2}} \end{aligned}$$

By changing variables, we finally obtain

$$\begin{aligned} E_z &= \frac{\rho_s}{\pi\epsilon_0} \tan^{-1} \left\{ \frac{ab}{h(a^2 + b^2 + h^2)^{1/2}} \right\} \bar{a}_z \\ &= 36(10^{-3})(0.0878 \text{ radians}) \bar{a}_z = \underline{\underline{31.61 \mu\text{V/m}}} \end{aligned}$$

Prob 4.12

$$\begin{aligned} \vec{E} &= \vec{E}_1 + \vec{E}_2 + \vec{E}_3 \\ &= \frac{Q}{4\pi\epsilon_0 r^2} \bar{a}_r + \frac{\rho_l}{2\pi\epsilon_0 \rho} \bar{a}_\rho + \frac{\rho_s}{2\epsilon_0} \bar{a}_n \\ &= \frac{100(10^{-12})}{4\pi\left(\frac{10^{-9}}{36\pi}\right)} \left\{ \frac{(1,1,1) - (4,1,-3)}{|(1,1,1) - (4,1,-3)|^3} \right\} + \frac{2(10^{-9})}{2\pi\left(\frac{10^{-9}}{36\pi}\right)} \left\{ \frac{(1,1,1) - (1,0,0)}{|(1,1,1) - (1,0,0)|^2} \right\} + \frac{5(10^{-9})}{2\pi\left(\frac{10^{-9}}{36\pi}\right)} \bar{a}_z \\ &= (-0.0216, 0, 0.0288) + (0, 18, 18) - 90\pi(0, 0, 1) \\ &= \underline{\underline{-0.0216 \bar{a}_x + 18 \bar{a}_y - 264.7 \bar{a}_z \text{ V/m}}} \end{aligned}$$

Prob 4.13

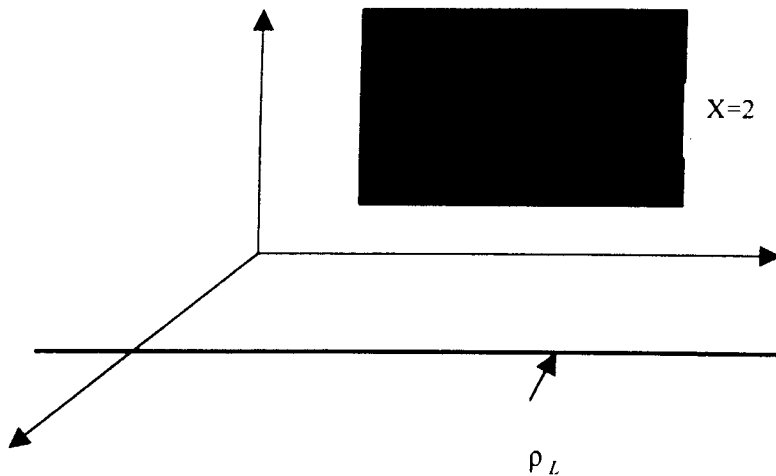

$$\bar{E} = \frac{\rho_s}{2\epsilon_0} \bar{a}_n + \frac{\rho_L}{2\pi\epsilon_0\rho} \bar{a}_\rho$$

$$\bar{\rho} = (0,0,0) - (3,0,-1) = -3\bar{a}_x + \bar{a}_z$$

$$\begin{aligned} \bar{E} &= \frac{4(10^{-9})}{2(10^{-9}/36\pi)} (\bar{a}_x) + \frac{20(10^{-9})}{2\pi(10^{-9}/36\pi)} \frac{(-3\bar{a}_x + \bar{a}_z)}{(9+1)} \\ &= 72\pi \bar{a}_x + 36(-3\bar{a}_x + \bar{a}_z) \end{aligned}$$

$$\begin{aligned} \bar{F} &= q \bar{E} = -5(36) [(2\pi - 3)\bar{a}_x + \bar{a}_z] \text{ mN} \\ &= \underline{\underline{-0.591\bar{a}_x - 0.18\bar{a}_z \text{ N}}} \end{aligned}$$

Prob 4.14

$$\bar{D} = \sum_{k=1}^4 \frac{Q_k(\bar{r} - \bar{r}_k)}{4\pi|\bar{r} - \bar{r}_k|^3}$$

$$\begin{aligned} \bar{D} &= \frac{Q}{4\pi} \left\{ \frac{2[(0,0,0) - (2,2,0)]}{|(0,0,0) - (2,2,0)|^3} - \frac{2[(0,0,0) - (-2,-2,0)]}{|(0,0,0) - (-2,-2,0)|^3} + \frac{[(0,0,6) - (-2,2,0)]}{|(0,0,6) - (-2,2,0)|^3} \right. \\ &\quad \left. - \frac{[(0,0,6) - (2,-2,0)]}{|(0,0,6) - (2,-2,0)|^3} \right\} \\ &= \frac{15}{4\pi} \left\{ \frac{2(-2,-2,6)}{44^{3/2}} - \frac{2(2,2,6)}{44^{3/2}} + \frac{2(2,-2,6)}{44^{3/2}} - \frac{2(-2,2,6)}{44^{3/2}} \right\} \\ &= \frac{15}{4\pi(44)^{3/2}} (-4, -12, 0) \mu\text{C}/\text{m}^2 \\ &= \underline{\underline{-16.36\bar{a}_x - 49.08\bar{a}_y \text{ nC}/\text{m}^2}} \end{aligned}$$

Prob 4.15

Let Q_1 be located at the origin. At the spherical surface of radius r ,

$$Q_1 = \oint \bar{D} \cdot d\bar{S} = \epsilon E_r (4\pi r^2)$$

or

$$\bar{E} = \frac{Q_1}{4\pi\epsilon r^2} \bar{a}_r \quad \text{by Gauss's law.}$$

If a second charge Q_2 is placed on the spherical surface, Q_2 experiences a force:

$$\bar{F} = Q_2 \bar{E} = \frac{Q_1 Q_2}{4\pi\epsilon r^2} \bar{a}_r$$

which is Columb's law.

Prob. 4.16

(a)

$$\rho_v = \nabla \cdot \bar{D} = \frac{\partial D_x}{\partial x} + \frac{\partial D_y}{\partial y} + \frac{\partial D_z}{\partial z} = 8y + 0 = \underline{\underline{8y \text{ C/m}^3}}$$

(b)

$$\begin{aligned} \rho_v = \nabla \cdot \bar{D} &= \frac{1}{\rho} \frac{\partial}{\partial \rho} (\rho^2 \sin \phi) + \frac{1}{\rho} \frac{\partial}{\partial \phi} (2\rho \cos \phi) + \frac{\partial}{\partial z} (2z^2) \\ &= 2 \sin \phi - 2 \sin \phi + 4z = \underline{\underline{4z \text{ C/m}^3}} \end{aligned}$$

(c)

$$\begin{aligned} \rho_v = \nabla \cdot \bar{D} &= \frac{1}{r^2} \frac{\partial}{\partial r} \left(\frac{2}{r} \cos \theta \right) + \frac{1}{r^4 \sin \theta} \frac{\partial}{\partial \theta} (\sin^2 \theta) \\ &= \frac{-2}{r^3} \cos \theta + \frac{1}{r^4 \sin \theta} (2 \sin \theta \cos \theta) = \underline{\underline{0}} \end{aligned}$$

Prob 4.17

(a)

$$\bar{D} = \epsilon_0 (\bar{E}) = 10^{-9} \frac{1}{36\pi} (xy \bar{a}_x + x^2 \bar{a}_y)$$

$$\bar{D} = \underline{\underline{8.84 xy \bar{a}_x + 8.84 x^2 \bar{a}_y \text{ pC/m}^2}}$$

(b)

$$\begin{aligned} \rho_v = \nabla \cdot \bar{D} &= \frac{\partial D_x}{\partial x} + \frac{\partial D_y}{\partial y} + \frac{\partial D_z}{\partial z} \\ &= \underline{\underline{8.84y \text{ pC/m}^3}} \end{aligned}$$

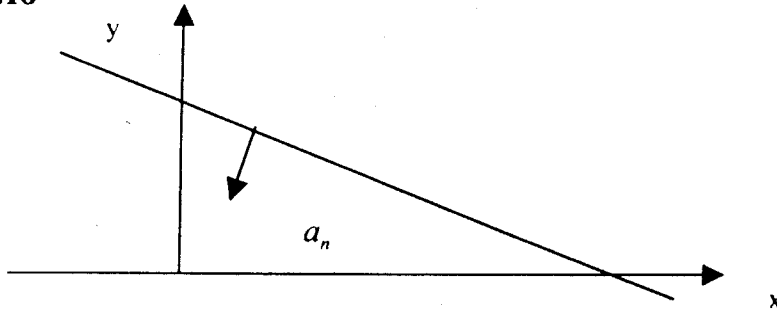
Prob 4.18

Let $f(x, y) = x + 2y - 5$; $\nabla f = \bar{a}_x + 2\bar{a}_y$

$$\bar{a}_n = \pm \frac{\nabla f}{|\nabla f|} = \pm \frac{(\bar{a}_x + 2\bar{a}_y)}{\sqrt{5}}$$

Since point $(-1, 0, 1)$ is below the plane,

$$\bar{a}_n = -\frac{(\bar{a}_x + 2\bar{a}_y)}{\sqrt{5}}$$

$$\begin{aligned} \bar{E} &= \frac{\rho_s}{2\epsilon_0} \bar{a}_n = \frac{6(10^{-9})}{2(10^{-9}/36\pi)} \left(-\frac{(\bar{a}_x + 2\bar{a}_y)}{\sqrt{5}} \right) \\ &= \underline{\underline{-151.7 \bar{a}_x - 303.5 \bar{a}_y \text{ V/m}}} \end{aligned}$$

Prob 4.19

$$W = \frac{1}{2} \int \bar{D} \cdot \bar{E} dV = \frac{1}{2\epsilon_0} \int |\bar{D}|^2 dV \text{ nJ}$$

$$\begin{aligned} 2\epsilon_0 W &= \iiint (4y^4 + 16x^2y^2 + 1) dx dy dz \\ &= 4 \int_{x=0}^2 dx \int_{y=1}^2 y^4 dy \int_{z=-1}^4 dz + 16 \int_{x=1}^2 x^2 dx \int_{y=1}^2 y^2 dy \int_{z=1}^4 dz + \int_{x=1}^2 dx \int_{x=-1}^2 dy \int_{x=-1}^4 dz \\ &= 4(3) \frac{y^5}{5} \Big|_1^2 (5) + 16 \left(\frac{x^3}{3} \Big|_1^2 \right)^2 (5) + (3)(3)(5) \\ &= 372 + 435.56 + 45 = 852.56 \end{aligned}$$

Thus,

$$W = \frac{10^{-9}}{2(10^{-9}/36\pi)} (852.56) = 853.56 = \underline{\underline{5.357 \text{ kJ}}}$$

Prob 4.20

(a)

$$\rho_{V'} = \nabla \cdot \vec{D} = \frac{1}{\rho} \frac{\partial}{\partial \rho} (\rho D_{\rho}) + \frac{1}{\rho} \frac{\partial D_{\phi}}{\partial \phi} + \frac{\partial D_z}{\partial z}$$

$$\rho_{V'} = 4(z+1)\cos\phi - (z+1)\cos\phi + 0$$

$$\rho_{V'} = \underline{\underline{3(z+1)\cos\phi \mu\text{C}/\text{m}^2}}$$

$$Q_{enc} = \int \rho_{V'} dv = \iiint 3(z+1)\cos\phi \rho d\phi d\rho dz$$

$$\begin{aligned} \text{(b)} \quad &= 3 \int_0^2 \rho d\rho \int_0^4 (z+1) \int_0^{\pi/2} \cos\phi d\phi = 3(2) \left(\frac{z^2}{2} + z \right) \Big|_0^{\pi/2} \\ &= 6(8+4)(1-0) = \underline{\underline{72\mu\text{C}}} \end{aligned}$$

(c)

$$\text{Let } \psi = \psi_1 + \psi_2 + \psi_3 + \psi_4 + \psi_5 = \oint \vec{D} \cdot d\vec{S}$$

where $\psi_1, \psi_2, \psi_3, \psi_4, \psi_5$ respectively correspond with surfaces S_1, S_2, S_3, S_4, S_5 (in the figure below) respectively.

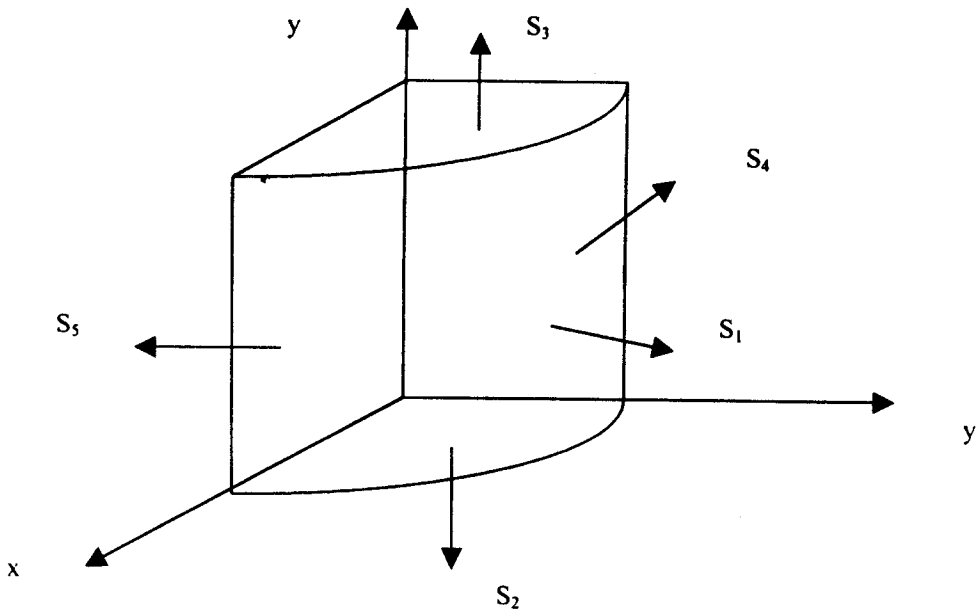

For S_1 , $\rho = 2$, $dS = \rho d\phi dz \bar{a}_\rho$

$$\begin{aligned}\psi_1 &= \iint 2\rho(z+1)\cos\phi \Big|_{\rho=2} = 2(2) \int_0^4 (z+1) dz \int_0^{\pi/2} \cos\phi d\phi \\ &= 4(12)(1) = 48\end{aligned}$$

For S_2 , $z = 0$, $dS = \rho d\phi d\rho (-\bar{a}_z)$

$$\begin{aligned}\psi_2 &= - \iint \rho^2 \cos\phi \rho d\phi d\rho = - \int_0^2 \rho^3 d\rho \int_0^{\pi/2} \cos\phi d\phi \\ &= - \frac{\rho^4}{4} \Big|_0^2 (1) = -4\end{aligned}$$

For S_3 , $z = 1$, $d\bar{S} = \rho d\phi d\rho \bar{a}_z$, $\psi_3 = +4$

For S_4 , $d = \pi/2$, $d\bar{S} = d\rho dz a_\phi$

$$\begin{aligned}\psi_4 &= - \iint \rho(z=1)\sin\phi d\rho dz \Big|_{d=\pi/2} = (11) \int_0^2 \rho d\rho \int_0^4 (z+1) dz \\ &= - \frac{\rho^2}{2} \Big|_0^2 (12) = -(2)(12) = -24\end{aligned}$$

For S_5 , $d = 0$, $d\bar{S} = d\rho dz (-\bar{a}_\phi)$, $\psi_5 = \iint \rho(z+1)\sin\phi d\rho dz \Big|_{d=0} = 0$

$$\psi = 48 - 4 + 4 - 24 + 0 = \underline{\underline{24\mu C}}$$

Prob. 4.21

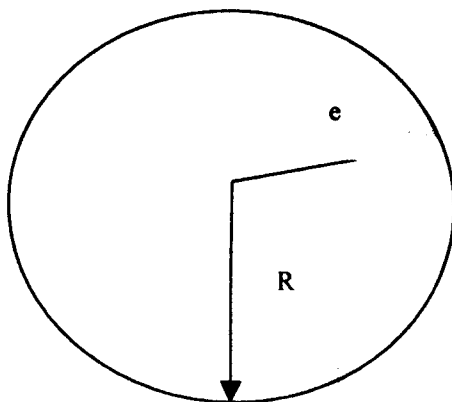

$$F = eE$$

$$\rho_0 = \frac{e}{4\pi \frac{R^3}{3}} = \frac{3e}{4\pi R^3}$$

$$\rho_r = \begin{cases} \rho_0, & 0 < r < R \\ 0, & \text{elsewhere} \end{cases}$$

$$\oint \bar{D} \cdot d\bar{S} = Q_{enc} = \int \rho_r dV = \frac{3e}{4\pi R^3} \frac{4\pi r^3}{3} = D_r (4\pi r^2)$$

$$E_r = \frac{3er}{12\pi\epsilon_0 R^3}$$

$$F = eE = \frac{e^2 r}{4\pi\epsilon_0 R^3}$$

Prob 4.22

(a)

$$\Psi = Q_{enc}$$

For $r = 1.5\text{m}$,

$$\begin{aligned} Q_{enc} &= \int \rho_{s1} ds = \rho_{s1} \int ds = \rho_{s1} (4\pi R^2) \\ &= 2(10^{-6})4\pi(1^2) = 8\pi(10^{-6}) \end{aligned}$$

$$\Psi = Q_{enc} = \underline{\underline{25.13 \mu\text{C}}}$$

For $r = 2.5\text{m}$,

$$\begin{aligned} Q_{enc} &= \rho_{s1}(4\pi R_1^2) + \rho_{s2}(4\pi R_2^2) \\ &= 8\pi(10^{-6}) + (-4)10^{-6}(4\pi 2^2) \\ &= (8\pi - 64\pi)10^{-6} \end{aligned}$$

$$\Psi = Q_{enc} = \underline{\underline{-175.93 \mu\text{C}}}$$

(b)

$$\Psi = Q_{enc}, \quad \int \bar{D} \cdot d\bar{S} = Q_{enc}$$

$$D_r (4\pi r^2) = Q_{enc}$$

$$D_r = \frac{Q_{enc}}{4\pi r^2}$$

$$\text{For } r = 0.5, \quad Q_{enc} = 0 \quad \longrightarrow \quad \underline{\underline{\bar{D} = 0}}$$

$$\text{For } r = 2.5, \quad Q_{enc} = -175.93 \mu C = -56\pi(10^{-6})$$

$$D_r = -\frac{56\pi(10^{-6})}{4\pi(25)} = \underline{\underline{-2.24\bar{a}_r \mu C/m^2}}$$

$$\text{For } r = 3.5, \quad Q_{enc} = \rho_{s1} 4\pi R_1^2 + \rho_{s2} 4\pi R_2^2 + \rho_{s3} 4\pi R_3^2$$

$$= -56\pi + 5(4\pi(3^3)) \mu C$$

$$= 124\pi \mu C$$

$$D_r = \frac{124\pi}{4\pi(3-5)^2} \mu C/m^2 = \underline{\underline{2.531\bar{a}_r \mu C/m^2}}$$

Prob 4.23

$$\text{For } \rho < 1, \quad Q_{enc} = 0 \quad \longrightarrow \quad \bar{D} = 0$$

$$\text{For } 1 < \rho < 2,$$

$$Q_{enc} = \int_{\phi=0}^{2\pi} \int_{\rho=1}^{\rho} \int_{z=0}^L 12\rho \, d\phi \, d\rho \, dz$$

$$= 12(2\pi)L \frac{\rho^3}{3} \Big|_1^{\rho} = 8\pi L(\rho^3 - 1)$$

$$\psi = \int \bar{D} \cdot d\bar{S} = D_\rho \int_{\rho=0}^{\rho} \int_{\phi=0}^{2\pi} \rho \, d\phi \, dz = D_\rho (2\pi\rho L)$$

Hence,

$$8\pi L(\rho^3 - 1) = D_\rho (2\pi\rho L)$$

$$D_\rho = \frac{8(\rho^3 - 1)}{2\rho}$$

$$\text{For } \rho > 2, \quad \psi = D_\rho (2\pi\rho L)$$

$$Q_{enc} = 8\pi L \rho^3 \Big|_1^2 = 56\pi L$$

$$56\pi L = D_\rho (2\pi\rho L)$$

$$D_\rho = \frac{28}{\rho}$$

$$\text{Thus, } D_\rho = \begin{cases} 0, & \rho < 1, & 1 < \rho < 2 \\ \frac{8(\rho^3 - 1)}{2\rho}, & \rho > 2 \\ \frac{28}{\rho} \end{cases}$$

Prob 4.24

(a)

$$\psi = Q_{enc} \quad \text{at } r = 2$$

$$\begin{aligned} Q_{enc} &= \int \rho_v dV = \iiint \frac{10}{r^2} r^2 \sin\theta \, d\theta \, dr \, d\phi \\ &= 10 \int_{r=0}^2 \int_{\phi=0}^{2\pi} \int_{\theta=0}^{\pi} \sin\theta \, d\theta \\ &= 10(2)(2\pi)(2) = (80\pi) \text{ mC} \end{aligned}$$

$$\text{Thus, } \psi = \underline{\underline{251.3 \text{ mC}}}$$

At $r = 6$;

$$\begin{aligned} Q_{enc} &= 10 \int_{r=0}^6 \int_{\phi=0}^{2\pi} \int_{\theta=0}^{\pi} \sin\theta \, d\theta \\ &= 10(4)(2\pi)(2) = 160\pi \\ \psi &= \underline{\underline{502.6 \text{ mC}}} \end{aligned}$$

(b)

$$\psi = Q_{enc}$$

$$\text{But } \psi = \oint \bar{D} \cdot d\bar{S} = D_r \oint dS = D_r(4\pi r^2)$$

At $r = 1$,

$$\begin{aligned} Q_{enc} &= 10 \int_{r=0}^1 \int_{\phi=0}^{2\pi} \int_{\theta=0}^{\pi} \sin\theta \, d\theta \\ Q_{enc} &= 10(1)(2\pi)(2) = 40\pi \end{aligned}$$

Thus,

$$D_r = \frac{Q_{enc}}{4\pi r^2} = \frac{40\pi}{4\pi(1)} = 10$$

$$\bar{D} = \underline{\underline{10 \bar{a}_r \text{ nC/m}^2}}$$

At $r = 5$, $Q_{enc} = 160 \pi$

$$D_r = \frac{Q_{enc}}{4\pi r^2} = \frac{160\pi}{4\pi(5)^2} = 1.6$$

$$= \underline{\underline{1.6 \bar{a}_r \text{ nC/m}^3}}$$

Prob. 4.25

Break up path $P(1,2,-4) \longrightarrow R(3,-5,6)$

$$P(1,2,-4) \quad R(3,-5,6)$$

\downarrow \uparrow

$$P'(3,2,-4) \longrightarrow R'(3,-5,-4)$$

$$\frac{-W}{Q} = \int \bar{E} \cdot d\bar{l} = \left\{ \int_P^{P'} + \int_{P'}^{R'} + \int_{R'}^R \right\} \bar{E} \cdot d\bar{l}$$

$$= \int_{x=1}^3 dx + \int_{y=2}^{-5} z^2 dy \Big|_{z=-4} + \int_{z=-4}^6 2yz dz \Big|_{y=-5}$$

$$= 2 + 16(-7) + 2(-5) \frac{z^2}{2} \Big|_{-4}^6 = 2 - 112 - 100 = -210$$

$$W = 210 Q = 210(5) = \underline{\underline{1050 \text{ J}}}$$

Prob 4.26

(a)

$$W_{AB} = q \int \bar{E} \cdot d\bar{l}, \quad d\bar{l} = d\rho \bar{a}_\rho$$

$$\frac{-W_{AB}}{q} = \int (z+1) \sin\phi \, d\rho \Big|_{\rho=0, z=0} = 0$$

$$W_{AB} = 0$$

(b)

$$\frac{-W_{BC}}{q} = \int_{\phi=0}^{30} (z+1) \cos\phi \, \rho \, d\phi \Big|_{\rho=4, z=0} = 4 \sin\phi \Big|_0^{30} = 2$$

$$W_{BC} = -2q = \underline{\underline{-8 \text{ nJ}}}$$

(c)

$$\frac{-W_{CD}}{q} = \int_{z=0}^{-2} \rho \sin \phi \, dz \Big|_{\substack{\phi=30^\circ \\ \rho=4}} = 4 \sin 30^\circ (z \Big|_0^{-2}) = -4$$

$$W_{CD} = 4q = \underline{\underline{16 \text{ nJ}}}$$

(d)

$$W_{AD} = W_{AB} + W_{BC} + W_{CD} = 0 - 8 + 16 = \underline{\underline{8 \text{ nJ}}}$$

Prob. 4.27

(a)

From A to B, $d\vec{l} = r d\theta \vec{a}_\theta$,

$$W_{AB} = -Q \int_{\theta=30^\circ}^{90^\circ} 10r \cos \theta \, r d\theta \Big|_{r=5} = \underline{\underline{-1250 \text{ nJ}}}$$

(b)

From A to C, $d\vec{l} = dr \vec{a}_r$,

$$W_{AC} = -Q \int_{r=5}^{10} 20r \sin \theta \, dr \Big|_{\theta=30^\circ} = \underline{\underline{-3750 \text{ nJ}}}$$

(c)

From A to D, $d\vec{l} = r \sin \theta \, d\phi \vec{a}_\phi$,

$$W_{AD} = -Q \int 0(r \sin \theta) d\phi = \underline{\underline{0 \text{ J}}}$$

(d)

$$W_{AE} = W_{AD} + W_{DF} + W_{FE}$$

where F is (10, 30, 60). Hence,

$$\begin{aligned} W_{AE} &= -Q \left\{ \int_{r=5}^{10} 20r \sin \theta \, dr \Big|_{\theta=30^\circ} + 10 \int_{\theta=30}^{90} 10r \cos \theta \, r d\theta \Big|_{r=10} \right\} \\ &= -100 \left[\frac{75}{2} + \frac{100}{2} \right] \text{ nJ} = \underline{\underline{-8750 \text{ nJ}}} \end{aligned}$$

Prob 4.28

$$W = qV_{AB} = q(V_B - V_A)$$

$$= 2(10^{-6})[2(1)(-3) - 1(1)(2)] = \underline{\underline{-16 \mu \text{ J}}}$$

Prob 4.29

(a)

$$\begin{aligned}\bar{E} &= -\nabla V = -(2x\bar{a}_x + 4y\bar{a}_y + 8z\bar{a}_z) \\ &= \underline{\underline{-2x\bar{a}_x + 4y\bar{a}_y + 8z\bar{a}_z \text{ V/m}}}\end{aligned}$$

(b)

$$\begin{aligned}-\bar{E} &= \frac{\partial V}{\partial x}\bar{a}_x + \frac{\partial V}{\partial y}\bar{a}_y + \frac{\partial V}{\partial z}\bar{a}_z \\ &= \cos(x^2 + y^2 + z^2)^{1/2} [2x\bar{a}_x + 2y\bar{a}_y + 2z\bar{a}_z] \left(\frac{1}{2}\right) \\ &= \underline{\underline{-(x\bar{a}_x + y\bar{a}_y + z\bar{a}_z) \cos(x^2 + y^2 + z^2)^{1/2} \text{ V/m}}}\end{aligned}$$

(c)

$$\begin{aligned}-\bar{E} &= \frac{\partial V}{\partial \rho}\bar{a}_\rho + \frac{1}{\rho} \frac{\partial V}{\partial \phi}\bar{a}_\phi + \frac{\partial V}{\partial z}\bar{a}_z \\ &= 2\rho(z+1) \sin\phi \bar{a}_\rho + \rho(z+1) \cos\phi \bar{a}_\phi + \rho^2 \sin\phi \bar{a}_z \\ &= \underline{\underline{-2\rho(z+1) \sin\phi \bar{a}_\rho - \rho(z+1) \cos\phi \bar{a}_\phi - \rho^2 \sin\phi \bar{a}_z}}\end{aligned}$$

(d)

$$\begin{aligned}\bar{E} &= \frac{\partial V}{\partial z}\bar{a}_z + \frac{1}{r} \frac{\partial V}{\partial \theta}\bar{a}_\theta + \frac{1}{r \sin\theta} \frac{\partial V}{\partial \phi}\bar{a}_\phi \\ -\bar{E} &= -e^x \sin\theta \cos 2\phi \bar{a}_r + \frac{1}{r} e^{-r} \cos\theta \cos 2\phi \bar{a}_\theta + \frac{e^{-r}}{r} (-2 \sin 2\phi) \bar{a}_\phi \\ \bar{E} &= \underline{\underline{e^x \sin\theta \cos 2\phi \bar{a}_r - \frac{1}{r} e^{-r} \cos\theta \cos 2\phi \bar{a}_\theta + \frac{2e^{-r}}{r} (\sin 2\phi) \bar{a}_\phi \text{ V/m}}}\end{aligned}$$

Prob 4.30 (a)

$$V_p = \sum \frac{Q_k}{4\pi |\bar{r}_p - \bar{r}_k|}$$

$$4\pi \epsilon_0 V_p = \frac{10^{-3}}{|(-1,1,2) - (0,0,4)|} + \frac{-2(10^{-3})}{{|(-1,1,2) - (-2,5,1)|}} + \frac{3(10^{-3})}{{|(-1,1,2) - (3,-4,6)|}}$$

$$4\pi \epsilon_0 (10^3) V_p = \frac{1}{|(-1,1,-2)|} - \frac{2}{|(1,-4,1)|} + \frac{3}{|(-4,5,-4)|} = \frac{1}{\sqrt{6}} - \frac{2}{\sqrt{18}} + \frac{3}{\sqrt{5}}$$

$$4\pi \frac{10^{-9}}{36\pi} (10^3) V_p = 0.3542$$

$$\therefore \underline{\underline{V_p = 3(10^6) \text{ V}}}$$

(b)

$$V_Q = \sum \frac{Q_k}{4\pi\epsilon_0 |\bar{r}_p - \bar{r}_k|}$$

$$4\pi\epsilon_0 V_Q = \frac{10^{-3}}{|(1,2,3) - (0,0,4)|} + \frac{-2(10^{-3})}{|(1,2,3) - (-2,5,1)|} + \frac{3(10^{-3})}{|(1,2,3) - (3,-4,6)|}$$

$$4\pi\epsilon_0 (10^3) V_P = \frac{1}{|(1,2,-1)|} - \frac{2}{|(3,-3,2)|} + \frac{3}{|(-2,6,-3)|} = \frac{1}{\sqrt{6}} - \frac{2}{\sqrt{22}} + \frac{3}{\sqrt{7}}$$

$$4\pi \frac{10^{-9}}{36\pi} (10^3) V_P = 0.410$$

$$V_Q = \underline{\underline{3.694 (10^6) \text{ V}}}$$

$$\therefore V_{PQ} = V_Q - V_P = \underline{\underline{0.69(10^6) = 694 \text{ kV}}}$$

Prob 4.31

(a)

$$\bar{E} = -\left(\frac{\partial V}{\partial x} \bar{a}_x + \frac{\partial V}{\partial y} \bar{a}_y + \frac{\partial V}{\partial z} \bar{a}_z\right)$$

$$= -2xy(z+3)\bar{a}_x - x^2(z+3)\bar{a}_y - x^2y\bar{a}_z$$

$$\text{At } (3,4,-6), \quad x=2, \quad y=4, \quad z=-6,$$

$$\bar{E} = -2(3)(4)(-3)\bar{a}_x - 9(-3)\bar{a}_y - 9(4)\bar{a}_z$$

$$= \underline{\underline{72\bar{a}_x + 27\bar{a}_y - 36\bar{a}_z \text{ V/m}}}$$

(b)

$$\rho_V = \nabla \cdot \bar{D} = \epsilon_0 \nabla \cdot \bar{E} = -\epsilon_0 (2y)(z+3)$$

$$\Psi = Q_{enc} = \int \rho_V dV = -2\epsilon_0 \iiint y(z+3) dx dy dz$$

$$= -2\epsilon_0 \int_0^1 dx \int_0^1 y dy \int_0^1 (z+3) dz = -2\epsilon_0 (1)(1/2) \left(\frac{z^2}{2} + 3z\right) \Big|_0^1$$

$$= -\epsilon_0 \left(\frac{1}{2} + 3\right) = \frac{-7}{2} \left(\frac{10^{-9}}{36\pi}\right)$$

$$Q_{enc} = \underline{\underline{-30.95 \text{ pC}}}$$

Prob 4.32

$$\bar{E} = \begin{cases} \frac{\rho_0 a^3}{4\epsilon_0 r^2} \bar{a}_r, & r > a \\ \frac{\rho_0 r^3}{4\epsilon_0 a} \bar{a}_r, & r < a \end{cases}$$

Since $V = - \int \bar{E} \cdot d\bar{l} = - \int E dr$,

$$V = \begin{cases} \frac{-\rho r^3}{12\epsilon_0 a} + C_1, & r < a \\ \frac{\rho a^3}{4\epsilon_0 r} + C_2, & r > a \end{cases}$$

But $V(\infty) = 0 \longrightarrow C_2 = 0$;

$$V(r = a) = \frac{\rho_0 a^2}{4\epsilon_0} = \frac{-\rho_0 a^2}{12\epsilon_0} + C_1 \longrightarrow C_1 = \frac{\rho_0}{3C_0}$$

$$\text{Thus, } V = \begin{cases} \frac{-\rho_0 r^3}{12\epsilon_0 a} + \frac{\rho_0 a^2}{3\epsilon_0}, & r < a \\ \frac{\rho_0}{4\epsilon_0 r}, & r > a \end{cases}$$

Prob 4.33

(a)

$$\nabla \times \bar{E} = \begin{vmatrix} \frac{\partial}{\partial x} & \frac{\partial}{\partial y} & \frac{\partial}{\partial z} \\ yz & xz & xy \end{vmatrix}$$

$$= (x - x)\bar{a}_x + (y - y)\bar{a}_y + (z - z)\bar{a}_z = \underline{\underline{0}}$$

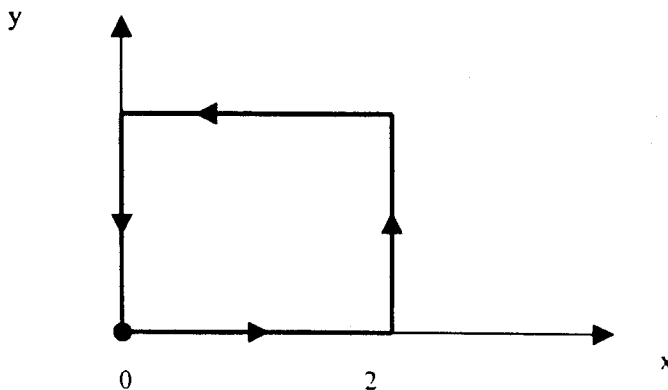

$$\begin{aligned}
 \oint \vec{E} \cdot d\vec{l} &= \int_{x=0}^2 yz dx \Big|_{y=0}^{y=l} + \int_{y=0}^2 xz dy \Big|_{z=l}^{z=2} + \int_{x=2}^0 yz dx \Big|_{y=2}^{y=l} + \int_{y=2}^0 xz dy \Big|_{z=l}^{z=1} \\
 &= 2y \Big|_0^2 + 2x \Big|_0^2 = 4 - 4 = \underline{\underline{0}}
 \end{aligned}$$

Prob. 4.34 (a)

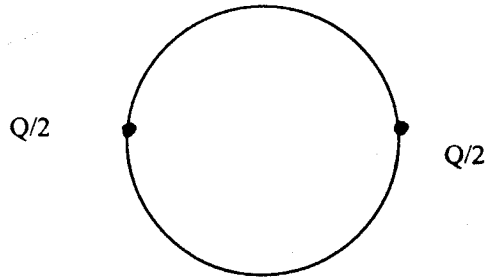

$$\begin{aligned}
 V &= \frac{2 \frac{Q}{2}}{4\pi\epsilon_0 r} = \frac{Q}{4\pi\epsilon_0 r} \\
 &= \frac{60(10^{-6})}{4\pi(10^{-9}) \frac{1}{36\pi}} = \underline{\underline{15 \text{ kV}}}
 \end{aligned}$$

(b)

$$V = \frac{3 \left(\frac{Q}{3}\right)}{4\pi\epsilon_0 r} = \underline{\underline{15 \text{ kV}}}$$

(c)

$$V = \int \frac{\rho_L}{4\pi\epsilon_0 r} = \frac{Q}{4\pi\epsilon_0 r} = \underline{\underline{15 \text{ kV}}}$$

Prob 4.35 (a)

For $r \geq a$,

$$Q_{enc} = \int \rho_V dV = \iiint \rho_0 (a^2 - r^2) r^2 \sin\theta d\theta d\phi dr$$

$$Q_{enc} = \rho_0 \int_0^\pi \sin\theta d\theta \int_0^{2\pi} d\phi \int_0^a (a^2 r^2 - r^4) dr$$

$$Q_{enc} = 4\pi\rho_0\left(a^2\frac{r^3}{3} - \frac{r^5}{5}\right)\bigg|_0^r$$

$$Q_{enc} = \frac{8\pi}{15}\rho_0 r^3$$

$$\psi = \int \vec{D} \cdot d\vec{S} = \epsilon_0 E_r (4\pi r^2)$$

$$\psi = Q_{enc} :$$

$$\epsilon_0 E_r (4\pi r^2) = \frac{8\pi}{15}\rho_0 r^3$$

$$E_r = \frac{2\rho_0}{15\epsilon_0 r^2} \quad \text{or}$$

$$\vec{E} = \frac{2\rho_0}{15\epsilon_0 r^2} \vec{a}_r$$

$$V = \int \vec{E} \cdot d\vec{l} = -\frac{2\rho_0}{15\epsilon_0} \int r^{-2} dr = \frac{2\rho_0}{15\epsilon_0 r} + C_1$$

$$\text{Since } V(r \rightarrow \infty) = 0, \quad C_1 = 0;$$

$$V = \frac{2\rho_0}{15\epsilon_0 r}$$

(b)

For $r \leq a$,

$$Q_{enc} = \rho_0 (4\pi) \left(\frac{a^2 r^3}{3} - \frac{r^5}{5} \right) \bigg|_0^r = 4\pi\rho_0 \left(\frac{a^2 r^3}{3} - \frac{r^5}{5} \right)$$

$$E_r = \frac{Q_{enc}}{4\pi\epsilon_0 r^2} = \frac{\rho_0}{\epsilon_0} \left(\frac{a^2 r}{3} - \frac{r^3}{5} \right)$$

$$\vec{E} = \frac{\rho_0}{\epsilon_0} \left(\frac{a^2 r^2}{3} - \frac{r^4}{5} \right) \vec{a}_r$$

$$V = -\int \vec{E} \cdot d\vec{l} = -\frac{\rho_0}{\epsilon_0} \left(\frac{a^2 r^2}{6} - \frac{r^4}{20} \right) + C_2$$

$$= \frac{\rho_0}{\epsilon_0} \left(\frac{r^4}{20} - \frac{a^2 r^2}{6} \right) + C_2$$

$$\text{Since } V(r = a^+) = V(r = a^-),$$

$$\frac{2\rho_0}{15\epsilon_0 a} = \frac{\rho_0}{\epsilon_0} \left(\frac{a^4}{20} - \frac{a^4}{6} \right) + C_2 \quad \longrightarrow \quad C_2 = \frac{2\rho_0}{15\epsilon_0 a} + \frac{7\rho_0 a^4}{60\epsilon_0}$$

$$V = \frac{\rho_0}{\epsilon_0} \left(\frac{r^4}{20} - \frac{a^2 r^2}{6} \right) + \frac{2\rho_0}{15\epsilon_0} + \frac{7\rho_0 a^4}{60\epsilon_0}$$

(c)

The total charge is found in part (a) as

$$Q = \frac{8\pi\rho_0}{15}$$

(d)

For $r \geq a$, \bar{E} decays to zero with no maxima.

For $r \leq a$,

$$E_r = \frac{\rho_0}{\epsilon_0} \left(\frac{a^2 r}{3} - \frac{r^3}{5} \right)$$

$$\frac{\partial E_r}{\partial r} = \frac{\rho_0}{\epsilon_0} \left(\frac{a^2}{3} - \frac{3r^2}{5} \right) = 0 \quad \longrightarrow \quad r = \frac{a\sqrt{5}}{3}$$

$$r = \underline{\underline{0.7453a}}$$

Prob 4.36

$m \frac{d^2 y}{dt^2} = eE$; divide by m , and integrate once, one obtains:

$$u \frac{dy}{dt} = \frac{eEt}{m} + c_0$$

$$y = \frac{eEt^2}{2m} + c_0 t + c_1 \quad (1)$$

"From rest" implies $c_1 = 0 = c_0$

At $t = t_0$, $y = d$, $E = \frac{V}{d}$ or $V = Ed$.

Substituting this in (1) yields:

$$t^2 = \frac{2md}{eE}$$

Hence:

$$u = \frac{eE}{m} \sqrt{\frac{2md}{eE}} = \sqrt{\frac{2eE}{m}}$$

that is, $u \propto \sqrt{V}$

or $u = k \sqrt{V}$

(b)

$$\begin{aligned} k &= \sqrt{\frac{2e}{m}} = \sqrt{\frac{2(1.603)10^{-19}}{9.1066(10^{-31})}} \\ &= \underline{\underline{5.933(10^5)}} \end{aligned}$$

(c)

$$V = \frac{u^2 m}{2e} = \frac{9(10^{16}) \frac{1}{100}}{2(176)(10^{11})} = \underline{\underline{2557 \text{ kV}}}$$

Prob 4.37

(a)

This is similar to Example 4.3.

$$u_y = \frac{eEt}{m}, \quad u_x = u_0$$

$$y = \frac{eEt^2}{2m}, \quad x = u_0 t$$

$$t = \frac{x}{u_0} = \frac{10(10^{-2})}{10^7} = 10 \text{ ns}$$

Since $x = 10 \text{ cm}$ when $y = 1 \text{ cm}$,

$$E = \frac{2my}{et^2} = \frac{2(10^{-2})}{1.76(10^{11})(10^{-16})} = 1.136 \text{ kV/m}$$

$$E = \underline{\underline{-1.136 \bar{a}_y \text{ kV/m}}}$$

(b)

$$u_x = u_0 = 10^7,$$

$$u_y = \frac{2000}{1.76} (1.76)10^{11}(10^{-8}) = 2(10^6)$$

$$\bar{u} = \underline{\underline{(\bar{a}_x + 0.2\bar{a}_y)(10^7) \text{ m/s}}}$$

Prob 4.38

$$V = \frac{p \cos \theta}{4\pi \epsilon_0 r} = \frac{k \cos \theta}{r}$$

$$\text{At } (0, 1 \text{ nm}), \quad \theta = 0, \quad r = 1 \text{ nm}, \quad V = 9;$$

$$\text{that is, } 9 = \frac{k(1)}{1(10^{-18})}, \quad \therefore k = 9(10^{-18})$$

$$V = 9(10^{-18}) \frac{\cos \theta}{r}$$

$$\text{At } (1, 1) \text{ nm}, \quad r = \sqrt{2} \text{ nm}, \quad \theta = 45^\circ,$$

$$V = \frac{9(10^{-18}) \cos 45^\circ}{10^{-18} \sqrt{2}} = \frac{9}{2\sqrt{2}} = \underline{\underline{3.182 \text{ V}}}$$

Prob 4.39

The dipole is oriented along y -axis.

$$V = \frac{\bar{p} \cdot \bar{r}}{4\pi \epsilon_0 r^2}; \quad \bar{p} \cdot \bar{r} = Qd \bar{a}_y \cdot \bar{a}_r = Qd \sin \theta \sin \phi$$

$$V = \frac{Qd \sin \theta \sin \phi}{4\pi \epsilon_0 r^2}$$

$$\begin{aligned} \bar{E} &= -\nabla V = -\frac{\partial V}{\partial r} \bar{a}_r - \frac{1}{r} \frac{\partial V}{\partial \theta} \bar{a}_\theta - \frac{1}{r \sin \theta} \frac{\partial V}{\partial \phi} \bar{a}_\phi \\ &= \frac{Qd}{4\pi \epsilon_0} \left\{ \frac{2 \sin \theta \sin \phi}{r^3} \bar{a}_r - \frac{\cos \theta \sin \phi}{r^3} \bar{a}_\theta - \frac{\cos \theta}{r^3} \bar{a}_\phi \right\} \end{aligned}$$

$$\bar{E} = \underline{\underline{\frac{Qd}{4\pi \epsilon_0} (2 \sin \theta \sin \phi \bar{a}_r - \cos \theta \sin \phi \bar{a}_\theta - \cos \theta \bar{a}_\phi)}}$$

Prob 4.40

$$\begin{aligned} W &= Q_2 V_{21} = Q_2 \frac{Q_1}{4\pi \epsilon_0 |\bar{r}_2 - \bar{r}_1|} \\ &= \frac{-2(1)(10^{-6})}{4\pi \left(\frac{10^{-9}}{36\pi}\right) |(5, -10, -1)|} = \frac{-18(10^{-3})}{\sqrt{126}} \end{aligned}$$

$$W = \underline{\underline{-1.604}}$$

Prob 4.41

$$W = \frac{1}{2} \int \bar{D} \cdot \bar{E} \, dv = \frac{\epsilon_0}{2} \int |\bar{E}| \, dv,$$

$$\bar{E} = \frac{Q}{4\epsilon_0 r^2} \bar{a}_r,$$

$$W = \frac{\epsilon_0}{2} \iiint \frac{Q^2}{16\pi^2\epsilon_0 r^4} (r^2 \sin\theta \, dr \, d\theta \, d\phi)$$

$$W = \frac{Q^2}{32\pi^2\epsilon_0} 4\pi \int_a^\infty \frac{1}{r^2} \, dr = \underline{\underline{\frac{Q^2}{8\pi\epsilon_0 a}}}$$

Prob 4.42

$$W = \frac{1}{2} \epsilon_0 \int |\bar{E}|^2 \, dv = \frac{1}{2} \epsilon_0 \iiint (4r^2 \sin^2\theta \cos^2\phi + r^2 \cos^2\theta \cos^2\phi + r^2 \sin^2\phi) r^2 \sin\theta \, d\theta \, d\phi$$

$$= \frac{1}{2} \epsilon_0 \int r^4 \, dr \left\{ 4 \int_0^{2\pi} \cos^2\phi \, d\phi \int_0^\pi \sin^3\theta \, d\theta + \int_0^{2\pi} \cos^2\phi \, d\phi \int_0^\pi \cos\theta \sin\theta \, d\theta \right.$$

$$\left. + \int_0^{2\pi} \sin^2\phi \, d\phi \int_0^\pi \sin\theta \, d\theta \right\}$$

$$= \frac{1}{2} \epsilon_0 \frac{r^5}{5} \Big|_0^2 \left\{ 4 \left(\frac{1}{2} \right) (2\pi) \int_0^\pi (1 - \cos^2\theta) \, d(-\cos\theta) \right.$$

$$\left. + \frac{1}{2} (2\pi) \int_0^\pi \cos^2\theta \, d(-\cos\theta) + \frac{1}{2} (2\pi) (-\cos\theta) \Big|_0^\pi \right\}$$

$$= 3.2 \epsilon_0 \left[4\pi \left(\frac{\cos^3\theta}{3} - \cos\theta \right) \Big|_0^\pi + \pi \left(-\frac{\cos^3\theta}{3} \right) \Big|_0^\pi + 2\pi \right]$$

$$= 3.2 \epsilon_0 (8\pi) = 25.6 \pi \frac{10^{-9}}{36\pi}$$

$$W = \underline{\underline{0.7111 \, nJ}}$$

Prob 4.43

$$\bar{E} = -\nabla V = -\left(\frac{\partial V}{\partial \rho}\bar{a}_\rho + \frac{1}{\rho}\frac{\partial V}{\partial \phi}\bar{a}_\phi + \frac{\partial V}{\partial z}\bar{a}_z\right)$$

$$\bar{E} = -(2\rho z \sin\phi \bar{a}_\rho + \rho z \cos\phi \bar{a}_\phi + \rho^2 \sin\phi \bar{a}_z)$$

$$W = \frac{1}{2}\epsilon_0 \int |\bar{E}|^2 dv = \iiint (4\rho^2 z^2 \sin^2\phi + \rho^2 z^2 \cos^2\phi + \rho^4 \sin^2\phi)\rho d\phi dz d\rho$$

$$\begin{aligned} \frac{2W}{\epsilon_0} &= 4 \int_1^4 \rho^3 dz \int_{-2}^2 z^2 dz \int_0^{\pi/3} \sin^2\phi d\phi + \int_1^4 \rho^3 d\rho \int_{-2}^2 z^2 dz \int_0^{\pi/3} \cos^2\phi d\phi \\ &\quad + \int_1^4 \rho^5 d\rho \int_{-2}^2 dz \int_0^{\pi/3} \sin^2\phi d\phi \end{aligned}$$

$$\text{But } \int_0^{\pi/3} \cos^2\phi d\phi = \frac{1}{2} \int_0^{\pi/3} [1 + \cos 2\phi] d\phi = \frac{\pi}{6} + \frac{1}{4} \sin \frac{2\pi}{3} = 0.7401$$

$$\int_0^{\pi/2} \sin^2\phi d\phi = \frac{1}{2} \int_0^{\pi/2} (1 - \cos 2\phi) d\phi = \frac{\pi}{6} - \frac{1}{4} \sin^2 \frac{\pi}{3} = 0.3071$$

$$\begin{aligned} \frac{2W}{\epsilon_0} &= \frac{4}{4} \rho^4 \left| \frac{2z^2}{3} \right|_0^2 (0.3071) + \frac{\rho^4}{4} \left| \frac{2z^3}{3} \right|_0^2 (0.7401) + \frac{\rho^6}{6} \left| (4) \right|_0^4 (0.3071) \\ &= 255 \left(\frac{16}{3} \right) (0.3071) + \frac{255}{4} \left(\frac{16}{3} \right) (0.7401) + \frac{4096}{6} (0.3071) \\ &= 417.67 + 239.394 + 838.59 = 1495.6 \end{aligned}$$

$$\begin{aligned} W &= \frac{1495.6}{2} \left(\frac{10^{-9}}{36\pi} \right) \\ &= \underline{\underline{6.612 \text{ nJ}}} \end{aligned}$$

CHAPTER 5

P. E. 5.1 $dS = \rho d\phi dz a_\rho$

$$I = \int J \cdot dS = \int_{\phi=0}^{2\pi} \int_{z=1}^5 10z \sin^2 \phi \rho dz d\phi \Big|_{\rho=2} = 10(2) \frac{z^2}{2} \Big|_1^5 \int_0^{2\pi} \frac{1}{2} (1 - \cos 2\phi) d\phi = 240\pi$$

$$I = 754 \text{ A}$$

P. E. 5.2

$$I = \rho_s w u = 0.5 \times 10^{-6} \times 0.1 \times 10 = 0.5 \mu \text{ A}$$

$$V = IR = 10^{14} \times 0.5 \times 10^{-6} = \underline{\underline{50 \text{ MV}}}$$

P. E. 5.3 $\sigma = 5.8 \times 10^7 \text{ S/m}$

$$J = \sigma E \longrightarrow E = \frac{J}{\sigma} = \frac{8 \times 10^6}{5.8 \times 10^7} = \underline{\underline{0.138 \text{ V/m}}}$$

$$J = \rho_v u \longrightarrow u = \frac{J}{\rho_v} = \frac{8 \times 10^6}{1.81 \times 10^{10}} = \underline{\underline{4.42 \times 10^{-4} \text{ m/s}}}$$

P. E. 5.4 The composite bar can be modeled as a parallel combination of resistors as shown below.

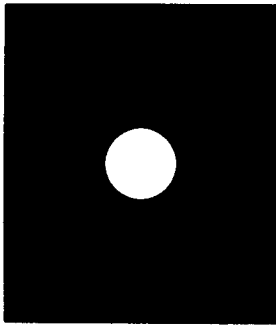
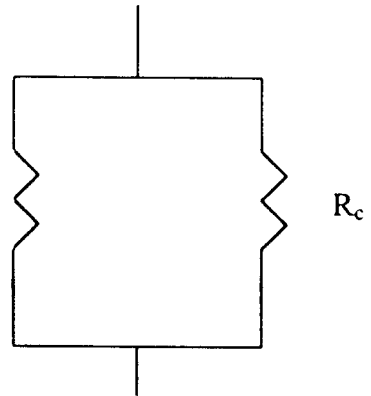
 R_L

 R_C

For the lead, $R_L = \frac{l}{\sigma_L S_L}$, $S_L = d^2 - \pi r^2 = 9 - \frac{\pi}{4} \text{ cm}^2$

$$R_L = 0.974 \text{ m}\Omega$$

For copper, $R_C = \frac{l}{\sigma_C S_C}$, $S_C = \pi r^2 = \frac{\pi}{4} \text{ cm}^2$

$$R_c = \frac{4}{5.8 \times 10^{-7} \times \frac{\pi}{4} \times 10^{-4}} = 0.8781 \text{ m}\Omega$$

$$R_c = \frac{R_l R_c}{R_l + R_c} = \frac{0.974 \times 0.8781}{0.974 + 0.8781} = \underline{\underline{461.7 \mu\Omega}}$$

P. E. 5.5 $\rho_{ps} = P \cdot a_x = ax^2 + b$

$$\rho_{ps} \Big|_{x=0} = P \cdot (-a_x) \Big|_{x=0} = \underline{\underline{-b}}$$

$$\rho_{ps} \Big|_{x=L} = P \cdot a_x \Big|_{x=L} = \underline{\underline{aL^2 + b}}$$

$$Q_s = \int \rho_{ps} dS = -bA + (aL^2 + b)A = AaL^2$$

$$\rho_{pv} = -\nabla \cdot P = -\frac{d}{dx}(ax^2 + b) = -2ax$$

$$\rho_{pv} \Big|_{x=0} = \underline{\underline{0}}, \quad \rho_{pv} \Big|_{x=L} = \underline{\underline{-2aL}}$$

$$Q_v = \int \rho_{pv} dv = \int_0^L (-2ax) A dx = -AaL^2$$

Hence,

$$Q_T = Q_v + Q_s = -AaL^2 + AaL^2 = 0$$

P. E. 5.6

$$E = \frac{V}{d} a_x = \frac{10^3}{2 \times 10^{-3}} a_x = 500 a_x \text{ kV/m}$$

$$P = \chi_e \epsilon_0 E = (2.25 - 1) \times \frac{10^{-9}}{36\pi} \times 0.5 \times 10^6 a_x = \underline{\underline{6.853 a_x \mu\text{C}/\text{m}^2}}$$

$$\rho_{ps} = P \cdot a_x = \underline{\underline{6.853 \mu\text{C}/\text{m}^2}}$$

P. E. 5.7 (a) Since $P = \epsilon_0 \chi_e E$, $P_x = \epsilon_0 \chi_e E_x$

$$\chi_e = \frac{P_x}{\epsilon_0 E_x} = \frac{3 \times 10^9}{10\pi} \frac{1}{5} \times 36\pi \times 10^9 = \underline{\underline{2.16}}$$

$$(b) E = \frac{P}{\chi_e \epsilon_o} = \frac{36\pi \times 10^9}{2.16} \frac{1}{10\pi} (3, -1, 4) 10^{-9} = \underline{\underline{5a_x - 1.67a_y + 6.67a_z}} \text{ V/m}$$

(c)

$$D = \epsilon_o \epsilon_r E = \frac{\epsilon_r P}{\chi_e} = \frac{3.16}{2.16} \left(\frac{1}{10\pi} \right) (3, -1, 4) \text{ nC/m}^2 = \underline{\underline{139.7a_x - 46.6a_y + 186.3a_z}} \text{ pC/m}^2$$

P. E. 5.8 From Example 5.8,

$$F = \frac{\rho_s^2 S}{2\epsilon_o} \longrightarrow \rho_s^2 = \frac{2\epsilon_o F}{S}$$

But $\rho_s = \epsilon_o E = \epsilon_o \frac{V_d}{d}$. Hence

$$\rho_s^2 = \frac{2\epsilon_o F}{S} = \frac{\epsilon_o^2 V_d^2}{d^2} \longrightarrow V_d^2 = \frac{2Fd^2}{\epsilon_o S}$$

i.e.

$$V_d = V_1 - V_2 = \sqrt{\frac{2Fd^2}{\epsilon_o S}}$$

as required.

P. E. 5.9 (a) Since $a_n = a_x$,

$$D_{1n} = 12a_x, \quad D_{1t} = -10a_x + 4a_z, \quad D_{2n} = D_{1n} = 12a_x$$

$$E_{2t} = E_{1t} \longrightarrow D_{2t} = \frac{\epsilon_2 D_{1t}}{\epsilon_1} = \frac{1}{2.5} (-10a_x + 4a_z) = -4a_x + 1.6a_z$$

$$D_2 = D_{2n} + D_{2t} = \underline{\underline{-12a_x - 4a_x + 1.6a_z}} \text{ nC/m}^2.$$

$$(b) \tan \theta_2 = \frac{D_{2t}}{D_{2n}} = \frac{\sqrt{(-4)^2 + (1.6)^2}}{12} = 0.359 \longrightarrow \underline{\underline{\theta_2 = 19.75^\circ}}$$

$$(c) E_{1t} = E_{2t} = E_2 \sin \theta_2 = 12 \sin 60^\circ = 10.392$$

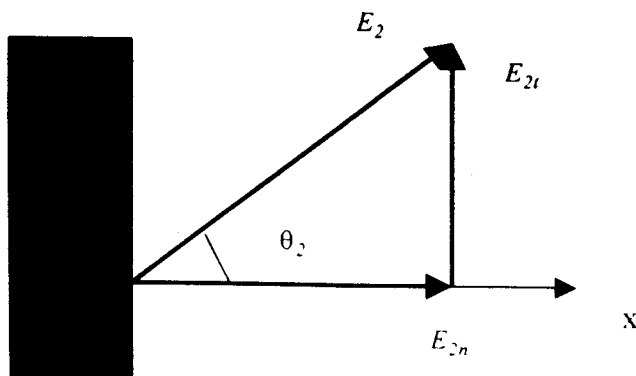

$$E_{1n} = \frac{\epsilon_{r2}}{\epsilon_{r1}} E_{2n} = \frac{1}{2.5} 12 \cos 60^\circ = 2.4$$

$$E_1 = \sqrt{E_{1n}^2 + E_{1t}^2} = \underline{\underline{10.67}}$$

$$\tan \theta_1 = \frac{\epsilon_{r1}}{\epsilon_{r2}} \tan \theta_2 = \frac{2.5}{1} \tan 60^\circ = 4.33 \quad \longrightarrow \quad \underline{\underline{\theta_1 = 77^\circ}}$$

Note that $\theta_1 > \theta_2$.

P. E. 5.10

$$D = \epsilon_o E = \frac{10^{-9}}{36\pi} (60, 20, -30) \times 10^{-3} = \underline{\underline{0.531a_x + 0.177a_y - 0.265a_z}} \text{ pC/m}^2$$

$$\rho_s = D_n = |D| = \frac{10^{-9}}{36\pi} (10) \sqrt{36 + 4 + 9} (10^{-3}) = \underline{\underline{0.619}} \text{ pC/m}^2$$

Prob. 5.1

$$I = \int J \cdot dS, \quad dS = r \sin \theta d\phi dr a_\theta$$

$$I = - \int_{r=0}^2 \int_{\phi=0}^{2\pi} r^3 \sin^2 \theta d\phi dr \Big|_{\theta=30^\circ} = -(\sin 30^\circ)^2 \frac{r^4}{4} \Big|_0^2 (2\pi) = -2\pi = \underline{\underline{-6.283}} \text{ A}$$

Prob. 5.2

$$I = \int J \cdot dS = \int_{\rho=0}^a \int_{\phi=0}^{2\pi} \frac{500}{\rho} \rho d\phi d\rho = 500(2\pi a) = 1000\pi \times 1.6 \times 10^{-3} = 1.6\pi = \underline{\underline{5.026}} \text{ A}$$

Prob. 5.3

$$I = \int J \cdot dS = 10 \int_{\rho=0}^a \int_{\phi=0}^{2\pi} e^{-(1-\rho/a)} \rho d\phi d\rho = 20\pi \int_{\rho=0}^a \rho e^{-(1-\rho/a)} d\rho$$

$$\text{But } \int x e^{ax} dx = \frac{e^{ax}}{a^2} (ax - 1),$$

$$I = 20\pi e^{-t} a^2 \left(\frac{\rho}{a} - I \right) e^{\rho/a} \Big|_0^a = \frac{20\pi a^2}{e} (I + 0) = \underline{\underline{23.11a^2}} \text{ A}$$

Prob. 5.4

$$I = \frac{dQ}{dt} = -3 \times 10^{-4} e^{-3t}$$

$$I(t=0) = -0.3 \text{ mA}$$

$$I(t=2.5) = -0.3 e^{-7.5} = -166 \text{ nA}$$

Prob. 5.5 (a) $\nabla^2 V = -\rho_v / \epsilon$

$$\nabla^2 V = \frac{\partial}{\partial x} (2xy^2z) + \frac{\partial}{\partial y} (2x^2yz) = 6xyz$$

$$\rho_v = -8xyz(2\epsilon_0) = \underline{\underline{-16xyz\epsilon_0}}$$

$$(b) \quad J = \rho_v u = -16xy^2z\epsilon_0(10^4)a_y$$

$$I = \int J \cdot dS = -16(10^4) \frac{10^{-9} 0.5}{36\pi} \int_0^{0.5} x dx \int_0^{0.5} z dz = -16(36\pi)(10^{-5}) \left(\frac{x^2}{2} \Big|_0^{0.5} \right)^2$$

$$I = -4(36\pi)(10^{-5})(0.5)^2 = \underline{\underline{-1.131}} \text{ mA}$$

$$\text{Prob. 5.6 (a)} \quad R = \frac{l}{\sigma S} = \frac{8 \times 10^{-2}}{3 \times 10^4 \times \pi \times 25 \times 10^{-6}} = \frac{8}{75\pi} = \underline{\underline{33.95 \text{ m}\Omega}}$$

$$(b) \quad I = V/R = 9 \times \frac{75\pi}{8} = \underline{\underline{265.1}} \text{ A}$$

$$(c) \quad P = IV = 2.386 \text{ kW}$$

$$\text{Prob. 5.7 (a)} \quad R = \frac{\rho l}{S} \longrightarrow \rho = RS/l = \frac{4.04}{10^3} \frac{\pi d^2}{4} = 2.855 \times 10^{-8}$$

$$\sigma = 1/\rho = \underline{\underline{3.5 \times 10^7}} \text{ S/m (Aluminum)}$$

$$(b) \quad J = I/S = \frac{40}{\frac{\pi}{4} \times 90 \times 10^{-6}} = \underline{\underline{5.66 \times 10^6}} \text{ A/m}^2$$

or

$$J = \sigma E = 3.5 \times 0.1616 \times 10^7 = 5.66 \times 10^6 \text{ A/m}^2$$

Prob. 5.8

$$R = \frac{l}{\sigma S}, \quad S = \pi r^2 = \pi d^2 / 4, d = 0.4 \text{ mm}, \quad l = N 2\pi R = N\pi D, \quad D = 6.5 \text{ mm}$$

$$R = \frac{150 \times \pi (6.5) \times 10^{-3}}{5.8 \times 10^{-7} \times \pi \frac{(0.4)^2}{4} \times 10^{-6}} = \underline{\underline{0.42 \Omega}}$$

$$\text{Prob. 5.9 (a)} \quad R = \frac{\rho_c l}{S}, \quad S_i = \pi r_i^2 = \pi (1.5)^2 \times 10^{-4} = 2.25\pi \times 10^{-4}$$

$$S_o = \pi (r_o^2 - r_i^2) = \pi (4 - 2.25) \times 10^{-4} = 1.75\pi \times 10^{-4}$$

$$R = R_i // R_o = \frac{R_i R_o}{R_i + R_o} = \left(\frac{\frac{\rho_i \rho_o}{S_i S_o}}{\frac{\rho_i}{S_i} + \frac{\rho_o}{S_o}} \right) l = 10 \left(\frac{\frac{1.77 \times 11.8 \times 10^{-16}}{2.25\pi \times 1.75\pi \times 10^{-8}}}{\frac{1.77 \times 10^{-8}}{1.75\pi \times 10^{-4}} + \frac{11.8 \times 10^{-8}}{2.25\pi \times 10^{-4}}} \right) = \underline{\underline{0.27 \text{ m}\Omega}}$$

$$(b) \quad V = I_i R_i = I_o R_o \quad \longrightarrow \quad \frac{I_i}{I_o} = \frac{R_o}{R_i} = \frac{0.3219}{1.669} = 0.1929$$

$$I_i + I_o = 1.1929 I_o = 60 \text{ A}$$

$$I_o = \underline{\underline{50.3 \text{ A}}} \quad (\text{copper}), \quad I_i = \underline{\underline{9.7 \text{ A}}} \quad (\text{steel})$$

$$(c) \quad R = \frac{10 \times 1.77 \times 10^{-8}}{1.75\pi \times 10^{-4}} = \underline{\underline{0.322 \text{ m}\Omega}}$$

Prob. 5.10

$$R = \frac{l}{\sigma S} = \frac{h}{\sigma \pi (b^2 - a^2)} = \frac{2}{10^5 \pi (25 - 9) \times 10^{-4}} = \underline{\underline{4 \text{ m}\Omega}}$$

Prob. 5.11

$$|P| = n|p| = nQd = 2ned = \chi_e \epsilon_o E \quad (Q = 2e)$$

$$\chi_e = \frac{2ned}{\epsilon_o E} = \frac{2 \times 5 \times 10^{25} \times 1.602 \times 10^{-19} \times 10^{-18}}{\frac{10^{-9}}{36\pi} \times 10^4} = 0.000182$$

$$\epsilon_r = 1 + \chi_e = \underline{\underline{1.000182}}$$

Prob. 5.12

$$P = \frac{\sum_{i=1}^N q_i d_i}{v} = \frac{\sum_{i=1}^N p_i}{v}$$

$$|P| = \frac{N}{v} |p| = 2 \times 10^{19} \times 1.8 \times 10^{-27} = 3.6 \times 10^{-8}$$

$$P = |P| a_x = \underline{\underline{3.6 \times 10^{-18} a_x \text{ C/m}^2}}$$

But $P = \chi_e \epsilon_o E$ or $\chi_e = \frac{P}{\epsilon_o E} = \frac{3.6 \times 36 \pi \times 10^9 \times 10^{-18}}{10^5} = 0.0407$

$$\epsilon_r = 1 + \chi_e = \underline{\underline{1.0407}}$$

Prob. 5.13 (a) $E = -\nabla V = -\frac{dV}{dz} a_z = 600z a_z$

$$D = \epsilon_o \epsilon_r E = \frac{10^{-9}}{36\pi} (2.4) 600z a_z = \underline{\underline{12.73z a_z \text{ nC/m}^2}}$$

$$\rho_v = \nabla \cdot D = \frac{\partial D_z}{\partial z} = \underline{\underline{12.73 \text{ nC/m}^3}}$$

(b) $\chi_e = \epsilon_r - 1 = 1.4$

$$P = \chi_e \epsilon_o E = \frac{\chi_e D}{\epsilon_r} = \frac{1.4}{2.4} (12.73z) a_z = \underline{\underline{7.427z a_z \text{ nC/m}^2}}$$

$$\rho_{pv} = -\nabla \cdot P = \underline{\underline{-7.427 \text{ nC/m}^3}}$$

Prob. 5.14

$$\rho_{pv} = -\nabla \cdot P = \underline{\underline{0}}, \quad \rho_{ps} = P \cdot a_n = \underline{\underline{5 \sin \alpha y}}$$

Prob. 5.15 (a) Applying Coulomb's law,

$$E_r = \begin{cases} \frac{D_r}{\epsilon_o} = \frac{Q}{4\pi \epsilon_o r^2}, & b < r < a \\ \frac{D_r}{\epsilon} = \frac{Q}{4\pi \epsilon r^2}, & a < r < b \end{cases}$$

$$P = \frac{\epsilon_r - 1}{\epsilon_r} D \quad (= D - \epsilon E)$$

Hence

$$P_r = \frac{\epsilon_r - 1}{\epsilon_r} \cdot \frac{Q}{4\pi r^2}, \quad a < r < b$$

$$(b) \quad \rho_{pv} = -\nabla \cdot P = -\frac{1}{r^2} \frac{d}{dr} (r^2 P_r) = \underline{0}$$

(c)

$$\rho_{ps} = P \cdot (-a_r) = -\frac{Q}{4\pi a^2} \left(\frac{\epsilon_r - 1}{\epsilon_r} \right), \quad r = a$$

$$\rho_{ps} = P \cdot (a_r) = \frac{Q}{4\pi b^2} \left(\frac{\epsilon_r - 1}{\epsilon_r} \right), \quad r = b$$

Prob. 5.16

$$F_1 = \frac{Q_1 Q_2}{4\pi \epsilon_0 r^2}, \quad F_2 = \frac{Q_1 Q_2}{4\pi \epsilon_0 \epsilon_r r^2}$$

$$\frac{F_1}{F_2} = \epsilon_r = 4.5 / 2 = 2.25$$

$$\epsilon_r = 2.25, \quad \text{polystyrene}$$

Prob. 5.17

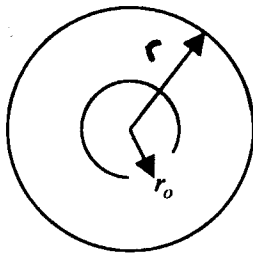

$$Q = 4\pi r_0^2 \rho_s, \quad r_0 = 10 \text{ cm}$$

From Gauss's law.

$$Q = \int D \cdot dS = D_n (4\pi r^2) \longrightarrow D_n = \frac{Q}{4\pi r^2} = \epsilon E$$

$$E = \frac{Q}{4\pi \epsilon r^2} a_r$$

At (-3cm, -4cm, 12cm), $r = 13 \text{ cm}$

$$E = \frac{4\pi r_0^2 \rho_v}{4\pi \epsilon r^2} a_r = \frac{(0.1)^2 \times 4 \times 10^{-9}}{10^{-9} \times 36\pi} a_r = \underline{\underline{107.1 a_r \text{ V/m}}}$$

Since $a_r = \frac{1}{13}(-3a_x + 4a_y + 12a_z)$,

$$E = \underline{\underline{-24.72a_x + 32.95a_y + 98.86a_z \text{ V/m}}}$$

Prob. 5.18

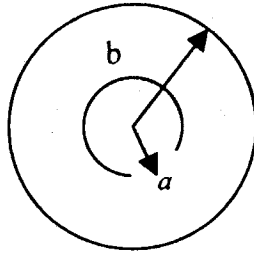

For $0 < r < a$.

$$D = \frac{Q}{4\pi r^2} a_r \quad \longrightarrow \quad E = \frac{Q}{4\pi \epsilon_0 r^2} a_r, \quad P = 0$$

For $a < r < b$.

$$D = \frac{Q}{4\pi r^2} a_r \quad \longrightarrow \quad E = \frac{Q}{4\pi \epsilon \epsilon_r r^2} a_r, \quad P = \chi_e \epsilon_0 E = \frac{\epsilon_r - 1}{\epsilon_r} \frac{Q}{4\pi r^2} a_r$$

For $r > b$.

$$D = \frac{Q}{4\pi r^2} a_r \quad \longrightarrow \quad E = \frac{Q}{4\pi \epsilon_0 r^2} a_r, \quad P = 0$$

Thus,

$$D = \frac{Q}{4\pi \epsilon r^2} a_r, \quad r > 0$$

$$E = \begin{cases} \frac{Q}{4\pi \epsilon \epsilon_r r^2} a_r, & a < r < b \\ \frac{Q}{4\pi \epsilon_0 r^2} a_r, & \text{otherwise} \end{cases}$$

$$P = \begin{cases} \frac{\epsilon_r - 1}{\epsilon_r} \frac{Q}{4\pi r^2} a_r, & a < r < b \\ 0, & \text{otherwise} \end{cases}$$

Prob. 5.19 (a)

$$\rho_v = \begin{cases} \rho_o, & 0 < r < a \\ 0, & r > a \end{cases}$$

$$\text{For } r < a, \quad \epsilon E_r (4\pi r^2) = \rho_o \frac{4\pi r^3}{3} \quad \longrightarrow \quad E_r = \frac{\rho_o r}{3\epsilon}$$

$$V = - \int E \cdot dl = - \frac{\rho_o r^2}{6\epsilon} + c_1$$

$$\text{For } r > a, \quad \epsilon_o E_r (4\pi r^2) = \rho_o \frac{4\pi a^3}{3} \quad \longrightarrow \quad E_r = \frac{\rho_o a^3}{3\epsilon_o r^2}$$

$$V = - \int E \cdot dl = \frac{\rho_o a^3}{3\epsilon_o r} + c_2$$

As $r \longrightarrow \infty$, $V = 0$ and $c_2 = 0$

At $r = a$, $V(a^+) = V(a^-)$

$$-\frac{\rho_o a^2}{6\epsilon_o \epsilon_r} + c_1 = \frac{\rho_o a^2}{3\epsilon_o} \quad \longrightarrow \quad c_1 = \frac{\rho_o a}{6\epsilon_o} (2\epsilon_r + 1)$$

$$V(r=0) = c_1 = \frac{\rho_o (2\epsilon_r + 1)}{6\epsilon_o}$$

$$(b) \quad V(r=a) = \frac{\rho_o a^2}{3\epsilon_o}$$

Prob. 5.20 Since $\frac{\partial \rho_v}{\partial t} = 0$, $\nabla \cdot J = 0$ must hold.

(a) $\nabla \cdot J = 6x^2y + 0 - 6x^2y = 0 \quad \longrightarrow \quad \text{This is possible.}$

(b) $\nabla \cdot J = y + (z+1) \neq 0 \quad \longrightarrow \quad \text{This is not possible.}$

(c) $\nabla \cdot J = \frac{1}{\rho} \frac{\partial}{\partial \rho} (z^2) + \cos \phi \neq 0 \quad \longrightarrow \quad \text{This is not possible.}$

(d) $\nabla \cdot J = \frac{1}{r^2} \frac{\partial}{\partial r} (\sin \theta) = 0 \quad \longrightarrow \quad \text{This is possible.}$

Prob. 5.21 (a)

$$\begin{bmatrix} D_x \\ D_y \\ D_z \end{bmatrix} = \epsilon_0 \begin{bmatrix} 4 & 1 & 1 \\ 1 & 4 & 1 \\ 1 & 1 & 4 \end{bmatrix} \begin{bmatrix} 10 \\ 10 \\ 0 \end{bmatrix}$$

$$D_x = 50\epsilon_0, \quad D_y = 50\epsilon_0, \quad D_z = 20\epsilon_0$$

$$\underline{\underline{D = 0.442a_x + 0.442a_y + 0.1768a_z \text{ nC/m}^2}}$$

(b)

$$\begin{bmatrix} D_x \\ D_y \\ D_z \end{bmatrix} = \epsilon_0 \begin{bmatrix} 4 & 1 & 1 \\ 1 & 4 & 1 \\ 1 & 1 & 4 \end{bmatrix} \begin{bmatrix} 10 \\ 20 \\ -30 \end{bmatrix}$$

$$D_x = 30\epsilon_0, \quad D_y = 60\epsilon_0, \quad D_z = 90\epsilon_0$$

$$\underline{\underline{D = 0.2653a_x + 0.5305a_y + 0.7958a_z \text{ nC/m}^2}}$$

$$\text{Prob. 5.22 (a)} \quad \nabla \cdot J = \frac{1}{\rho} \frac{\partial}{\partial \rho} \left(\frac{100}{\rho} \right) = -\frac{100}{\rho^3}$$

$$-\frac{\partial \rho_v}{\partial t} = \nabla \cdot J = -\frac{100}{\rho^3} \quad \longrightarrow \quad \frac{\partial \rho_v}{\partial t} = \underline{\underline{\frac{100}{\rho^3} \text{ C/m}^3 \cdot \text{s}}}}$$

$$(b) \quad I = \int J \cdot dS = \iint \frac{100}{\rho^3} \rho \, d\phi \, dz \Big|_{\rho=2} = \frac{100}{2^2} \int_0^{2\pi} d\phi \int_0^1 dz = 50\pi = \underline{\underline{157.1 \text{ A}}}$$

Prob. 5.23 (a)

$$I = \int J \cdot dS = \iint \frac{5e^{-10^4 t}}{r} r^2 \sin\theta \, d\theta \, d\phi \Big|_{r=2} = (2)(5)e^{-10^4 t} \int_0^\pi \sin\theta \, d\theta \int_0^{2\pi} d\phi = 40\pi e^{-10^4 t}$$

$$\text{At } t=0.1 \text{ ms}, \quad I = 40\pi e^{-1} = \underline{\underline{46.23 \text{ A}}}$$

$$-\frac{\partial \rho_v}{\partial t} = \nabla \cdot J \quad \longrightarrow \quad \rho_v = -\int \nabla \cdot J \, dt$$

$$\nabla \cdot J = \frac{1}{r^2} \frac{\partial}{\partial r} (r^2 J_r) = \frac{5}{r^2} e^{-10^4 t}$$

$$\rho_v = - \int \frac{5}{r^2} e^{-10^4 t} dt = \frac{5}{10^4 r^2} e^{-10^4 t}$$

At $t=0.1$ ms and $r = 2$ m,

$$\rho_v = \frac{5}{10^4 (2)^2} e^{-1} = \underline{\underline{45.98 \mu\text{C}/\text{m}^3}}$$

Prob. 5.24 (a) $\frac{\epsilon}{\sigma} = \frac{3.1 \times \frac{10^{-9}}{36\pi}}{10^{-15}} = \underline{\underline{2.741 \times 10^4 \text{ s}}}$

(b) $\frac{\epsilon}{\sigma} = \frac{6 \times \frac{10^{-9}}{36\pi}}{10^{-15}} = \underline{\underline{5.305 \times 10^4 \text{ s}}}$

(c) $\frac{\epsilon}{\sigma} = \frac{80 \times \frac{10^{-9}}{36\pi}}{10^{-4}} = \underline{\underline{7.07 \mu\text{s}}}$

Prob. 5.25 (a) $Q = Q_0 e^{-t/T_r} \longrightarrow \frac{1}{3} Q_0 = Q_0 e^{-t_1/T_r} \longrightarrow e^{t_1/T_r} = 3$

$$T_r = \frac{t_1}{\ln 3} = \frac{20 \mu\text{s}}{\ln 3} = \underline{\underline{18.2 \mu\text{s}}}$$

(b) But $T_r = \frac{\epsilon_r \epsilon_0}{\sigma}$, $\epsilon_r = \frac{\sigma T_r}{\epsilon_0} = \frac{10^{-5} \times 18.2 \times 10^{-6}}{\frac{10^{-9}}{36\pi}} = \underline{\underline{20.58}}$

(c) $\frac{Q}{Q_0} = e^{-t_0/T_r} = e^{-30/18.2} = 0.1923$ i.e. 19.23%

Prob. 5.26

$$T_r = \frac{\epsilon}{\sigma} = \frac{2.5 \times 10^{-9}}{5 \times 10^{-6} \times 36\pi} = 4.42 \mu\text{s}$$

$$\rho_{w0} = \frac{Q}{V} = \frac{10 \times 10^{-6}}{\frac{4\pi}{3} \times 10^{-6} \times 8} = \underline{\underline{0.2984 \text{ C}/\text{m}^3}}$$

$$\rho_v = \rho_{w0} e^{-t/T_r} = 0.2984 e^{-2.4/4.42} = \underline{\underline{0.1898 \text{ C}/\text{m}^3}}$$

Prob. 5.27 (a) $E_{2t} = E_{1t} = -300a_x + 50a_y$, $E_{1n} = 70a_z$

$$D_{2n} = D_{1n} \quad \longrightarrow \quad \epsilon_2 E_{2n} = \epsilon_1 E_{1n}$$

$$E_{2n} = \frac{\epsilon_1}{\epsilon_2} E_{1n} = \frac{2.5}{4} (70a_z) = 43.75a_z$$

$$E_2 = -30a_x + 50a_y + 43.75a_z$$

$$D_2 = \epsilon_0 \epsilon_r E_2 = 4x \frac{10^{-9}}{36\pi} (-30, 50, 43.75) = \underline{\underline{-1.061a_x + 1.768a_y + 1.547a_z \text{ nC/m}^2}}$$

(b) $P_2 = \epsilon_0 \chi_{e2} E_2 = 3x \frac{10^{-9}}{36\pi} (-30, 50, 43.75) = \underline{\underline{0.7958a_x + 1.326a_y + 1.161a_z \text{ nC/m}^2}}$

(c) $E_1 \cdot a_2 = E_1 \cos \theta_n$

$$\cos \theta_n = \frac{70}{\sqrt{30^2 + 50^2 + 70^2}} = 0.7683 \quad \longrightarrow \quad \underline{\underline{\theta_n = 39.79^\circ}}$$

Prob. 5.28

(a) $P_1 = \epsilon_0 \chi_{e1} E_1 = 2x \frac{10^{-9}}{36\pi} (10, -6, 12) = \underline{\underline{0.1768a_x - 0.1061a_y + 0.2122a_z \text{ nC/m}^2}}$

(b) $E_{1n} = -6a_x$, $E_{2t} = E_{1t} = 10a_x + 12a_z$

$$D_{2n} = D_{1n} \quad \longrightarrow \quad \epsilon_2 E_{2n} = \epsilon_1 E_{1n}$$

or $E_{2n} = \frac{\epsilon_1}{\epsilon_2} E_{1n} = \frac{3\epsilon_0}{4.5\epsilon_0} (-6a_x) = -4a_x$

$$\underline{\underline{E_2 = 10a_x - 4a_y + 12a_z \text{ V/m}}}$$

$$\tan \theta_2 = \frac{E_{2t}}{E_{2n}} = \frac{\sqrt{10^2 + 12^2}}{4} = 3.905 \quad \longrightarrow \quad \underline{\underline{\theta_2 = 75.64^\circ}}$$

(c) $w_E = \frac{1}{2} D \cdot E = \frac{1}{2} \epsilon |E|^2$

$$w_{E1} = \frac{1}{2} \epsilon_1 |E_1|^2 = \frac{1}{2} \times 3x \frac{10^{-9}}{36\pi} (10^2 + 6^2 + 12^2) = \underline{\underline{0.2219 \text{ nJ/m}^3}}$$

$$w_{E2} = \frac{1}{2} \epsilon_2 |E_2|^2 = \frac{1}{2} \times 4.5x \frac{10^{-9}}{36\pi} (10^2 + 4^2 + 12^2) = \underline{\underline{0.3208 \text{ nJ/m}^3}}$$

Prob. 5.29 (a) $D_{2n} = 12a_\rho = D_{1n}$, $D_{2t} = -6a_\phi - 9a_z$

$$E_{2t} = E_{2t} \longrightarrow \frac{D_{1t}}{\epsilon_1} = \frac{D_{2t}}{\epsilon_2}$$

$$D_{1t} = \frac{\epsilon_1}{\epsilon_2} D_{2t} = \frac{3.5\epsilon_0}{1.5\epsilon_0} (-6a_\phi + 9a_z) = -14a_\phi + 21a_z$$

$$D_1 = 12a_\rho - 14a_\phi + 21a_z \text{ nC/m}^2$$

$$E_1 = D_1 / \epsilon_1 = \frac{(12, -14, 21) \times 10^{-9}}{3.5 \times \frac{10^{-9}}{36\pi}} = \underline{\underline{387.8a_\rho - 452.4a_\phi + 678.6a_z \text{ V/m}}}$$

(b) $P_2 = \epsilon_0 \chi_{e2} E_2 = 0.5\epsilon_0 \frac{D_2}{\epsilon_2} = \frac{0.5\epsilon_0}{1.5\epsilon_0} (12, -6, 9) = \underline{\underline{4a_\rho - 2a_\phi + 3a_z \text{ nC/m}^2}}$

$$\rho_{v2} = \nabla \cdot P_2 = 0$$

(c) $w_{E1} = \frac{1}{2} D_1 \cdot E_1 = \frac{1}{2} \frac{D_1 \cdot D_1}{\epsilon_0 \epsilon_{r1}} = \frac{1}{2} \frac{(12^2 + 14^2 + 21^2) \times 10^{-18}}{3.5 \times \frac{10^{-9}}{36\pi}} = \underline{\underline{12.62 \text{ mJ/m}^2}}$

$$w_{E2} = \frac{1}{2} \frac{D_2 \cdot D_2}{\epsilon_0 \epsilon_{r2}} = \frac{1}{2} \frac{(12^2 + 6^2 + 9^2) \times 10^{-18}}{5 \times \frac{10^{-9}}{36\pi}} = \underline{\underline{9.839 \text{ mJ/m}^2}}$$

Prob. 5.30 (a)

$$P_1 = \epsilon_0 \chi_{e1} E_1 = 1.5 \times \frac{10^{-9}}{36\pi} (2, 5, -4) \times 10^3 = \underline{\underline{26.53a_\rho + 66.31a_\phi - 53.05a_z \text{ nC/m}^2}}$$

$$\rho_{pv1} = -\nabla \cdot P_1 = -\frac{1}{\rho} \frac{\partial}{\partial \rho} (26.53\rho) = -\frac{26.53}{\rho} \text{ nC/m}^3$$

(b) $E_{2t} = E_{1t} = 5a_\phi - 4a_z$

$$D_{2n} = D_{1n} \longrightarrow E_{2n} = \frac{\epsilon_1}{\epsilon_2} E_{1n} = \frac{2.5}{1.0} (2) = 5$$

$$E_2 = 5a_\rho + 5a_\phi - 4a_z \text{ kV/m}$$

$$D_2 = \epsilon_0 \epsilon_r E = 2.5 \times \frac{10^{-9}}{36\pi} (5, 5, -4) \times 10^3 = \underline{\underline{110.5a_\rho + 110.5a_\phi - 88.42a_z \text{ nC/m}^2}}$$

Prob. 5.31 (a)

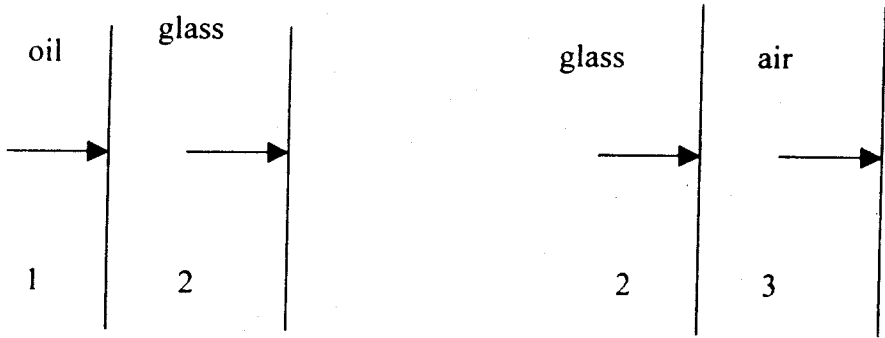

$$E_{1n} = 2000, \quad E_{1t} = 0 = E_{2t} = E_{3t}$$

$$D_{1n} = D_{2n} = D_{3n} \quad \longrightarrow \quad \epsilon_1 E_{1n} = \epsilon_2 E_{2n} = \epsilon_3 E_{3n}$$

$$E_{2n} = \frac{\epsilon_1}{\epsilon_2} E_{1n} = \frac{3.0}{8.5} (2000) = \underline{\underline{705.9 \text{ V/m}}}, \quad \theta_2 = 0^\circ$$

$$E_{3n} = \frac{\epsilon_1}{\epsilon_3} E_{1n} = \frac{3.0}{1.0} (2000) = \underline{\underline{6000 \text{ V/m}}}, \quad \theta_3 = 0^\circ$$

(b)

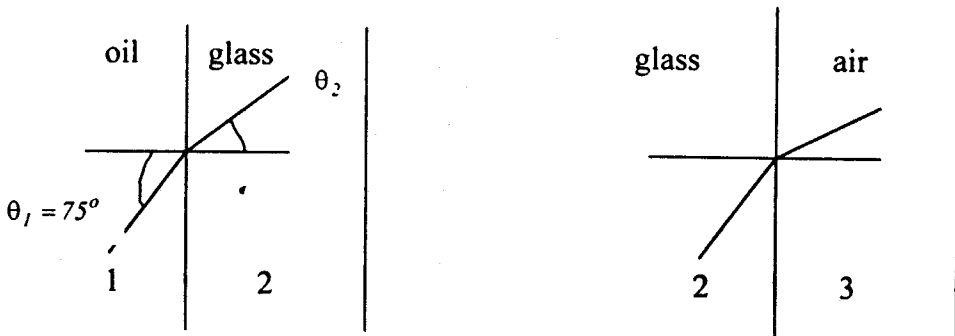

$$E_{1n} = 2000 \cos 75^\circ = 517.63, \quad E_{1t} = 2000 \sin 75^\circ = E_{2t} = E_{3t} = 1931.85$$

$$E_{2n} = \frac{\epsilon_1}{\epsilon_2} E_{1n} = \frac{3}{8.5} (517.63) = 182.7, \quad E_{3n} = \frac{\epsilon_1}{\epsilon_3} E_{1n} = \frac{3}{1} (517.63) = 1552.89$$

$$E_2 = \sqrt{E_{2n}^2 + E_{2t}^2} = 1940.5, \quad \theta_2 = \tan^{-1} \frac{E_{2t}}{E_{2n}} = \underline{\underline{84.6^\circ}}$$

$$E_3 = \sqrt{E_{3n}^2 + E_{3t}^2} = 2478.6, \quad \theta_3 = \tan^{-1} \frac{E_{3t}}{E_{3n}} = \underline{\underline{51.2^\circ}}$$

Prob. 5.32 (a) $\rho_s = D_n = \epsilon_o E_n = \frac{10^{-9}}{36\pi} \sqrt{15^2 + 8^2} = \underline{\underline{0.1503 \text{ nC/m}^2}}$

(b) $D_n = \rho_s = -20 \text{ nC}$

$$D = D_n a_n = (-20 \text{ nC})(-a_y) = \underline{\underline{20 a_y \text{ nC/m}^2}}$$

Prob. 5.33 (a)

$$D_n = \rho_s = \frac{Q}{4\pi a^2} = \frac{12 \times 10^{-9}}{4\pi \times 25 \times 10^{-4}} = \frac{1200}{\pi} \text{ nC/m}^2$$

$$\underline{\underline{|D| = 381.97 \text{ nC/m}^2}}$$

(b) Using Gauss' law,

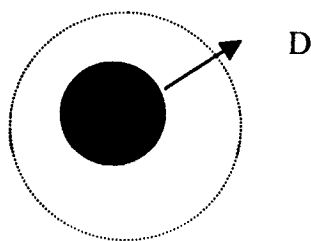

$$D_r 4\pi r^2 = Q \quad \longrightarrow \quad D_r = \frac{Q}{4\pi r^2}$$

$$D = \frac{Q}{4\pi r^2} a_r = \frac{12}{4\pi r^2} a_r \text{ nC/m}^2 = \underline{\underline{\frac{0.955}{r^2} a_r \text{ nC/m}^2}}$$

(c) $W = \frac{1}{2\epsilon_o} \int |D|^2 dv = \frac{Q^2}{2\epsilon_o 16\pi^2} \iiint \frac{1}{r^4} r^2 \sin\theta d\theta d\phi dr = \frac{Q^2}{32\pi^2 \epsilon_o} 4\pi \int_a^{\infty} \frac{dr}{r^2}$

$$= \frac{Q^2}{8\pi \epsilon_o a} = \frac{144 \times 10^{-18}}{8\pi \times \frac{10^{-9}}{36\pi} \times 5 \times 10^{-2}} = \underline{\underline{12.96 \mu\text{J}}}$$

CHAPTER 6

P. E. 6.1

$$\nabla^2 V = -\frac{\rho}{\epsilon} \longrightarrow \frac{d^2 V}{dx^2} = -\frac{\rho_0 x}{\epsilon_0}$$

$$V = -\frac{\rho_0 x^3}{6\epsilon a} + Ax + B$$

$$E = -\frac{dV}{dx} a_x = \left(\frac{\rho_0 x^2}{2\epsilon a} - A \right) a_x$$

If $E = 0$ at $x=0$, then

$$0 = 0 - A \longrightarrow A = 0$$

If $V = 0$ at $x=a$, then

$$0 = -\frac{\rho_0 a^3}{6\epsilon a} + B \longrightarrow B = \frac{\rho_0 a^2}{6\epsilon}$$

Thus

$$\underline{V = \frac{\rho_0}{6\epsilon a} (a^3 - x^3)}, \quad \underline{E = \frac{\rho_0 x^2}{2\epsilon a} a_x}$$

P. E. 6.2 $V_1 = A_1 x + B_1, \quad V_2 = A_2 x + B_2$

$$V_1(x=d) = V_0 = A_1 d + B_1 \longrightarrow B_1 = V_0 - A_1 d$$

$$V_1(x=0) = 0 = 0 + B_2 \longrightarrow B_2 = 0$$

$$V_1(x=a) = V_2(x=a) \longrightarrow A_1 + B_1 = A_2 a$$

$$D_{1n} = D_{2n} \longrightarrow \epsilon_1 A_1 = \epsilon_2 A_2 \longrightarrow A_2 = \frac{\epsilon_1}{\epsilon_2} A_1$$

$$A_1 a + V_0 - A_1 d = \frac{\epsilon_1}{\epsilon_2} a A_1 \longrightarrow V_0 = A_1 \left(-a + d + \frac{\epsilon_1}{\epsilon_2} a \right)$$

or

$$A_1 = \frac{V_0}{d - a + \epsilon_1 a / \epsilon_2}, \quad A_2 = \frac{\epsilon_1}{\epsilon_2} A_1 \frac{\epsilon_1 V_0}{\epsilon_2 d - \epsilon_2 a + \epsilon_1 a}$$

Hence

$$E_1 = -A_1 a_x = \frac{-V_0 a_x}{d - a + \epsilon_1 a / \epsilon_2}, \quad E_2 = -A_2 a_x = \frac{-V_0 a_x}{a + \epsilon_2 d / \epsilon_1 - \epsilon_2 a / \epsilon_1}$$

P. E. 6.3 From Example 6.3,

$$E = -\frac{V_o}{\rho\phi_o} a_\rho, \quad D = \epsilon_o E$$

$$\rho_s = D_n(\phi = 0) = -\frac{V_o \epsilon}{\rho\phi_o}$$

The charge on the plate $\phi = 0$ is

$$Q = \int \rho_s dS = -\frac{V_o \epsilon}{\phi_o} \int_{z=0}^L \int_{\rho=a}^b \frac{1}{\rho} dz d\rho = -\frac{V_o \epsilon}{\phi_o} L \ln(b/a)$$

$$C = \frac{|Q|}{V_o} = \frac{\epsilon L}{\phi_o} \ln \frac{b}{a}$$

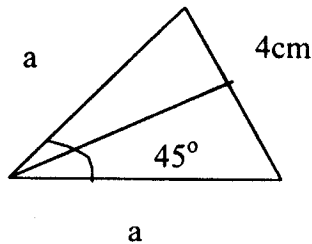

$$a \sin \frac{45^\circ}{2} = 2 \quad \longrightarrow \quad a = \frac{2}{\sin 22.5^\circ} = 5.226 \text{ mm}$$

$$C = \frac{1.5 \times 10^{-9}}{36\pi \times \frac{\pi}{4}} 5 \ln \frac{1000}{5.226} = 444 \text{ pF}$$

$$Q = CV_o = 444 \times 10^{-12} \times 50 = \underline{\underline{22.2 \text{ nC}}}$$

P. E. 6.4 From Example 6.4,

$$V_o = 50, \quad \theta_1 = \pi/2, \quad \theta_2 = 45^\circ, \quad r = \sqrt{3^2 + 4^2 + 2^2} = \sqrt{29}, \quad \theta = \tan^{-1} \frac{\rho}{z} = \frac{5}{2} \quad \longrightarrow \quad \theta = 68.2^\circ$$

$$V = \frac{50 \ln(\tan 34.1^\circ)}{\tan(22.5^\circ)} = \underline{\underline{22.13 \text{ V}}}, \quad E = \frac{-50 a_\theta}{\sqrt{29} \sin 68.2^\circ \ln \tan(22.5^\circ)} = \underline{\underline{11.36 a_\theta \text{ V/m}}}$$

P. E. 6.5

$$E = -\nabla V = -\frac{\partial V}{\partial x} a_x - \frac{\partial V}{\partial y} a_y$$

$$= -\frac{4V_o}{b} \sum_{n=\text{odd}} \frac{1}{\sinh n\pi a/b} \left[\cos(n\pi x/b) \sinh(n\pi y/b) a_x + \sin(n\pi x/b) \cosh(n\pi y/b) a_y \right]$$

(a) At $(x, y) = (a, a/2)$,

$$V = \frac{400}{\pi} (0.3775 - 0.0313 + 0.00394 - 0.000584 + \dots) = \underline{\underline{44.51 \text{ V}}}$$

$$E = 0a_x + (-115.12 + 19.127 - 3.9431 + 0.8192 - 0.1703 + 0.035 - 0.0094 + \dots)a_y \\ = \underline{\underline{-99.25a_y \text{ V/m}}}$$

(b) At $(x, y) = (3a/2, a/4)$,

$$V = \frac{400}{\pi} (0.1238 + 0.00626 - 0.00383 + 0.000264 + \dots) = \underline{\underline{16.50 \text{ V}}}$$

$$E = (24.757 - 3.7358 - 0.3834 - 0.0369 + 0.00351 - 0.00033 + \dots)a_x \\ + (-66.25 - 4.518 + 0.3988 + 0.03722 - 0.00352 - 0.000333 + \dots)a_y \\ = \underline{\underline{20.68a_x - 70.34a_y \text{ V/m}}}$$

P. E. 6.6

$$V(y=a) = V_o \sin(7\pi x/b) = \sum_{n=1}^{\infty} c_n \sin(n\pi x/b) \sinh(n\pi a/b)$$

By equating coefficients, we notice that $c_n = 0$ for $n \neq 7$. For $n=7$,

$$V_o \sin(7\pi x/b) = c_7 \sin(7\pi x/b) \sinh(7\pi a/b) \quad \longrightarrow \quad c_7 = \frac{V_o}{\sinh(7\pi a/b)}$$

Hence

$$V(x, y) = \frac{V_o}{\sinh(7\pi a/b)} \sin(7\pi x/b) \sinh(7\pi y/b)$$

P. E. 6.7 Let $V(r, \theta, \phi) = R(r)F(\theta)\Phi(\phi)$.

Substituting this in Laplace's equation gives

$$\frac{\Phi F}{r^2} \frac{d}{dr} \left(r^2 \frac{dR}{dr} \right) + \frac{R\Phi}{r^2 \sin\theta} \frac{d}{d\theta} \left(\sin\theta \frac{dF}{d\theta} \right) + \frac{RF}{r^2 \sin^2\theta} \frac{d^2\Phi}{d\phi^2} = 0$$

Dividing by $RF\Phi / r^2 \sin^2\theta$ gives

$$\frac{\sin^2\theta}{R} \frac{d}{dr} (r^2 R') + \frac{\sin\theta}{F} \frac{d}{d\theta} (\sin\theta F') = - \frac{1}{\Phi} \frac{d^2\Phi}{d\phi^2} = \lambda^2$$

$$\Phi'' + \lambda^2 \Phi = 0$$

$$\frac{1}{R} \frac{d}{dr} (r^2 R') = \frac{\lambda^2}{\sin^2 \theta} - \frac{l}{F \sin \theta} \frac{d}{d\theta} (\sin \theta F') = \mu^2$$

$$2R' + r^2 R'' = \mu^2 R$$

or

$$R'' + \frac{2}{r} R' - \frac{\mu^2}{r^2} R = 0$$

$$\frac{\sin \theta}{F} \frac{d}{d\theta} (\sin \theta F') - \lambda^2 + \mu^2 \sin^2 \theta = 0$$

or

$$F'' + \cot \theta F' + (\mu^2 - \lambda^2 \operatorname{cosec}^2 \theta) F = 0$$

P. E. 6.8 (a) This is similar to Example 6.8(a) except that here $0 < \phi < 2\pi$ instead of $0 < \phi < \pi/2$. Hence

$$I = \frac{2\pi t V_o \sigma}{\ln(b/a)} \quad \text{and} \quad R = \frac{V_o}{I} = \frac{\ln \frac{b}{a}}{2\pi t \sigma}$$

(b) This is similar to Example 6.8(b) except that here $0 < \phi < 2\pi$. Hence

$$I = \frac{V_o \sigma}{t} \int_a^b \int_0^{2\pi} \rho \, d\rho \, d\phi = \frac{V_o \sigma \pi (b^2 - a^2)}{t}$$

$$\text{and} \quad R = \frac{V_o}{I} = \frac{t}{\sigma \pi (b^2 - a^2)}$$

P. E. 6.9 From Example 6.9,

$$J_1 = \frac{\sigma_1 V_o}{\rho \ln \frac{b}{a}}, \quad J_2 = \frac{\sigma_2 V_o}{\rho \ln \frac{b}{a}}$$

$$I = \int J \cdot dS = \int_{z=0}^l \left[\int_{\phi=0}^{\pi} J_1 \rho \, d\phi + \int_{\phi=\pi}^{2\pi} J_2 \rho \, d\phi \right] dz = \frac{V_o l}{\ln \frac{b}{a}} [\pi \sigma_1 + \pi \sigma_2]$$

$$R = \frac{V_o}{I} = \frac{\ln \frac{b}{a}}{\pi l [\sigma_1 + \sigma_2]}$$

P. E. 6.10 (a) $C = \frac{4\pi\epsilon}{\frac{1}{a} - \frac{1}{b}}$, C_1 and C_2 are in series.

$$C_1 = 4\pi\epsilon \frac{10^{-9}}{36\pi} \left(\frac{2.5}{\frac{10^3}{2} - \frac{10^3}{3}} \right) = 5/3 \text{ pF}, \quad C_2 = 4\pi\epsilon \frac{10^{-9}}{36\pi} \left(\frac{3.5}{\frac{10^3}{1} - \frac{10^3}{2}} \right) = 7/9 \text{ pF}$$

$$C = \frac{C_1 C_2}{C_1 + C_2} = \frac{(5/3)(7/9)}{(5/3) + (7/9)} = \underline{\underline{0.53 \text{ pF}}}$$

(b) $C = \frac{2\pi\epsilon}{\frac{1}{a} - \frac{1}{b}}$, C_1 and C_2 are in parallel.

$$C_1 = 2\pi\epsilon \frac{10^{-9}}{36\pi} \left(\frac{2.5}{\frac{10^3}{1} - \frac{10^3}{3}} \right) = 5/24 \text{ pF}, \quad C_2 = 2\pi\epsilon \frac{10^{-9}}{36\pi} \left(\frac{3.5}{\frac{10^3}{1} - \frac{10^3}{3}} \right) = 7/24 \text{ pF}$$

$$C = C_1 + C_2 = \underline{\underline{0.5 \text{ pF}}}$$

P. E. 6.11 As in Example 6.8, assuming $V(\rho = a) = 0$, $V(\rho = b) = V_o$,

$$V = V_o \frac{\ln \rho / a}{\ln b / a}, \quad E = -\nabla V = -\frac{V_o}{\rho \ln b / a} a_\rho$$

$$Q = \int \epsilon E \cdot dS = \frac{V_o \epsilon}{\ln b / a} \int_{z=0}^L \int_{\phi=0}^{2\pi} \frac{1}{\rho} dz \rho d\phi = \frac{V_o 2\pi \epsilon L}{\ln b / a}$$

$$C = \frac{Q}{V_o} = \frac{2\pi \epsilon L}{\ln b / a}$$

P. E. 6.12 (a) C_1 and C_2 are in series.

$$C_1 = \frac{2\pi\epsilon_r \epsilon_o}{\ln c / a} = \frac{2\pi \times 2.5 \times 10^{-9}}{\ln 2 / 1 \times 36\pi} = 200 \text{ pF/m}, \quad C_2 = \frac{2\pi\epsilon_r \epsilon_o}{\ln b / c} = \frac{2\pi \times 3.5 \times 10^{-9}}{\ln 3 / 2 \times 36\pi} = 480 \text{ pF/m}$$

$$C = \frac{C_1 C_2}{C_1 + C_2} = \frac{200 \times 480}{200 + 480} = 141.12 \text{ pF}$$

$$C_T = C = \underline{141} \text{ nF}$$

(b) C_1 and C_2 are in parallel.

$$C = C_1 + C_2 = \frac{\pi \epsilon_{r1} \epsilon_0}{\ln b/a} + \frac{\pi \epsilon_{r2} \epsilon_0}{\ln b/a} = \frac{\pi (\epsilon_{r1} + \epsilon_{r2}) \epsilon_0}{\ln b/a} = \frac{6\pi}{\ln 3/7} \frac{10^{-9}}{36\pi} = 151.7 \text{ pF/m}$$

$$C_T = C = \underline{152} \text{ nF}$$

P. E. 6.13 Instead of Eq. (6.31), we now have

$$V = - \int_b^a \frac{Q dr}{4\pi \epsilon r^2} = - \int_b^a \frac{Q dr}{4\pi \frac{10\epsilon_0}{r} r^2} = - \frac{Q}{40\pi \epsilon_0} \ln b/a$$

$$C = \frac{Q}{|V|} = \frac{40\pi}{\ln 4/1.5} \frac{10^{-9}}{36\pi} = \underline{1.13} \text{ nF}$$

P. E. 6.14 Let

$$F = F_1 + F_2 + F_3 + F_4 + F_5$$

where F_i , $i = 1, 2, \dots, 5$ are shown on in the figure below.

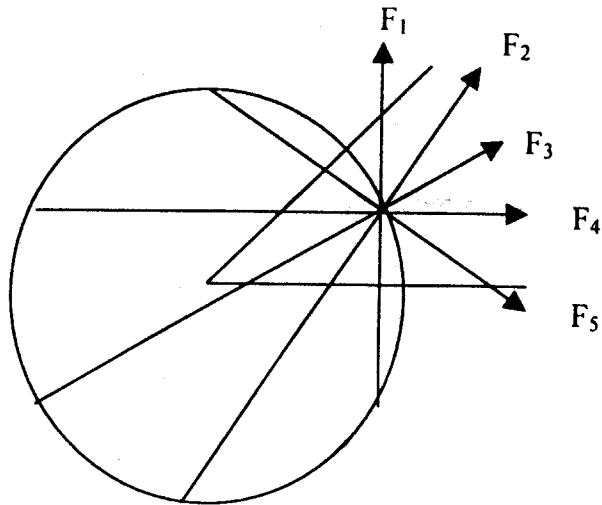

$$F = - \frac{Q^2}{4\pi \epsilon_0 r^2} + \frac{Q^2 (a_x \sin 30^\circ + a_y \cos 30^\circ)}{4\pi \epsilon_0 (r \cos 30^\circ)^2} - \frac{Q^2 (a_x \cos 30^\circ + a_y \sin 30^\circ)}{4\pi \epsilon_0 (2r)^2} + \frac{Q^2 a_x}{4\pi \epsilon_0 (r \cos 30^\circ)^2} - \frac{Q^2 (a_x \cos 30^\circ - a_y \sin 30^\circ)}{4\pi \epsilon_0 r^2}$$

$$= -\frac{Q^2}{4\pi\epsilon_0 r^2} \left[-a_y + \frac{4}{3} \left(\frac{a_x}{2} + \frac{\sqrt{3}a_y}{2} \right) - \frac{1}{4} \left(\frac{\sqrt{3}a_x}{2} + \frac{a_y}{2} \right) + \frac{4}{3} a_x - \frac{\sqrt{3}a_x}{2} + \frac{a_y}{2} \right]$$

$$= 9 \times 10^{-5} \left[a_x \left(2 - \frac{5\sqrt{3}}{8} \right) + a_y \left(\frac{4\sqrt{3}-5}{8} \right) \right] = 82.57 a_x + 21.69 a_y \text{ } \mu\text{N}$$

$$\underline{|F| = 85.37 \text{ } \mu\text{N}}$$

Prob. 6.1

$$E = -\nabla V = -\frac{\partial V}{\partial x} a_x - \frac{\partial V}{\partial y} a_y - \frac{\partial V}{\partial z} a_z = -6y^2 z a_x - 12xyz a_y - 6xy^2 a_z$$

At P(1,2,-5),

$$\underline{E = 120 a_x + 120 a_y - 12 a_z \text{ V/m}}$$

$$\nabla^2 V = \frac{\partial^2 V}{\partial x^2} + \frac{\partial^2 V}{\partial y^2} + \frac{\partial^2 V}{\partial z^2} = 0 + 12xz + 0$$

$$\rho_v = -\epsilon_0 \nabla^2 V = -12xz \epsilon_0$$

At P,

$$\rho_v = 60 \epsilon_0 = 60x \frac{10^{-9}}{36\pi} = 530.5 \text{ pC/m}^3$$

Prob. 6.2

$$\frac{d^2 V}{dx^2} = -\frac{\rho_v}{\epsilon_0} = -\frac{\frac{x}{6\pi} 10^{-9}}{10^{-9}/36\pi} = -6x$$

$$\frac{dV}{dx} = -3x^2 + A \longrightarrow V = -x^3 + Ax + B$$

$$-50 = -1 + A + B \longrightarrow A + B = -49$$

$$50 = -64 + 4A + B \longrightarrow 4A + B = 114$$

Thus, $A = 54.33$ and $B = -103.33$

$$V = -x^3 + 54.33x - 103.3$$

$$V(2) = -8 + 108.66 - 103.3 = \underline{\underline{-2.667}}$$

Prob. 6.3 (a)

$$\nabla^2 V = -\frac{\rho_v}{\epsilon_0} \longrightarrow \frac{d^2 V}{dx^2} = -\frac{\rho_0(x-d)}{d\epsilon_0} = -kx + kd, \quad k = \frac{\rho_0}{d\epsilon_0}$$

$$\frac{dV}{dx} = -kx^2/2 + kdx + A \longrightarrow V = -kx^3/6 + kdx^2/2 + Ax + B$$

$$\text{When } x=0, V=0 \longrightarrow 0 = B$$

$$\text{When } x=d, V=V_0, \longrightarrow V_0 = -kd^3/6 + kd^3/2 + Ad$$

$$\text{i.e. } A = V_0/d - kd^2/3$$

$$V = \underline{\underline{-\frac{\rho_0 x^3}{6d\epsilon_0} + \frac{\rho_0 x^2}{2\epsilon_0} + \left(\frac{V_0}{d} - \frac{\rho_0 d}{3\epsilon_0}\right)x}}$$

$$E = -\nabla V = \underline{\underline{-\frac{dV}{dx} a_x = \left(\frac{\rho_0 x^2}{2d\epsilon_0} - \frac{\rho_0 x}{\epsilon_0} - \frac{V_0}{d} + \frac{\rho_0 d}{3\epsilon_0}\right) a_x}}$$

$$(b) \rho_s = D_n = \epsilon_0 E_n = \epsilon_0 E \cdot a_n$$

$$\text{At } x=0, a_n = a_x, \quad \underline{\underline{\rho_s = \frac{\rho_0 d}{3} - \frac{\epsilon_0 V_0}{d}}}$$

$$\text{At } x=d, a_n = -a_x, \quad \rho_s = -\rho_0 d/2 + \rho_0 d + \epsilon_0 V_0/d - \rho_0 d/3$$

$$\underline{\underline{\rho_s = \frac{\epsilon_0 V_0}{d} + \frac{\rho_0 d}{6}}}$$

Prob. 6.4 If $V'' = f$,

$$V' = \int_0^x f(x) dx + c_1$$

$$V = \int_0^x \int_0^\lambda f(\mu) d\mu d\lambda + c_1 x + c_2$$

$$V(x=0) = V_1 = c_2 \longrightarrow c_2 = V_1$$

$$V(x=L) = V_2 = \int_0^L \int_0^\lambda f(\mu) d\mu d\lambda + c_1 L + c_2$$

$$c_1 = \frac{1}{L} \left[V_2 - V_1 - \int_0^L \int_0^\lambda f(\mu) d\mu d\lambda \right]$$

Thus,

$$V = \frac{x}{L} \left[V_2 - V_1 - \int_0^L \int_0^\lambda f(\mu) d\mu d\lambda \right] + V_1 + \int_0^x \int_0^\lambda f(\mu) d\mu d\lambda$$

Prob. 6.5

$$\nabla^2 V = \frac{d^2 V}{dx^2} = -\frac{\rho_v}{\epsilon} = -\frac{50(1-y^2) \cdot 10^6}{\epsilon} = -k(1-y^2)$$

where $k = \frac{50 \times 10^{-6}}{3 \times \frac{10^{-9}}{36\pi}} = 600\pi \times 10^3$

$$\frac{dV}{dy} = -k(y - y^3/3) + A$$

$$V = -k \left(\frac{y^2}{2} - \frac{y^4}{12} \right) + Ay + B = 50\pi \cdot 10^3 y^4 - 300\pi \cdot 10^3 y^2 + Ay + B$$

When $y=2\text{cm}$, $V=30 \times 10^3$,

$$30 \times 10^3 = 50\pi \times 10^3 \times 16 \times 10^{-6} - 300\pi \times 10^3 \times 4 \times 10^{-4} + Ay + B$$

or

$$30,374.5 = 0.02A + B \quad (1)$$

When $y=-2\text{cm}$, $V=30 \times 10^3$,

$$30,374.5 = -0.02A + B \quad (2)$$

From (1) and (2), $A=0$, $B=30,374.5$. Thus,

$$\underline{V = 157.08y^4 - 942.5y^2 + 30.374 \text{ kV}}$$

Prob. 6.6 (a)

$$\nabla^2 V_1 = \frac{\partial^2 V_1}{\partial x^2} + \frac{\partial^2 V_1}{\partial y^2} + \frac{\partial^2 V_1}{\partial z^2} = 2 + 2 - 4 = 0$$

i.e. Yes.

$$(b) \quad V_2 = \frac{1}{(x^2 + y^2 + z^2)^{1/2}} = 1/r = r^{-1}$$

$$\nabla^2 V_2 = \frac{1}{r^2} \frac{\partial}{\partial r} \left(r^2 \frac{\partial V_2}{\partial r} \right) + 0 = \frac{1}{r^2} \frac{\partial}{\partial r} \left(r^2 \frac{-1}{r^2} \right) = 0$$

i.e. Yes.

$$(c) \quad \nabla^2 V_3 = \frac{1}{\rho} \frac{\partial}{\partial \rho} \left(\rho \frac{\partial^2 V_3}{\partial \phi^2} \right) + \frac{1}{\rho^2} \frac{\partial^2 V_3}{\partial \phi^2} + \frac{\partial^2 V_3}{\partial z^2}$$

$$= \frac{1}{\rho} \frac{\partial}{\partial \rho} (\rho z \sin \phi) - \frac{z}{\rho} \sin \phi + 0 = \frac{z}{\rho} \sin \phi + 4 - \frac{z}{\rho} \sin \phi = 4$$

i.e. No.

$$(d) \quad \nabla^2 V_4 = 0 + \frac{10 \sin \phi}{r^4 \sin \theta} \frac{\partial}{\partial \theta} (\sin \theta \cos \theta) - \frac{10 \sin \theta \sin \phi}{r^4}$$

$$= \frac{10 \sin \phi (\cos^2 \theta - \sin^2 \theta)}{r^4 \sin \theta} - \frac{10 \sin \theta \sin \phi}{r^4} = \frac{10 \sin \phi}{r^4 \sin \theta} - \frac{30 \sin \theta \sin \phi}{r^4} \neq 0$$

i.e. No.

Prob. 6.7 (a)

$$\nabla^2 V = \frac{\partial^2 V}{\partial x^2} + \frac{\partial^2 V}{\partial y^2} + \frac{\partial^2 V}{\partial z^2} = \frac{\partial}{\partial x} (-5e^{-5x} \cos 13y \sinh 12z) + \dots = 25V - 169V + 144V = 0$$

$$(b) \quad \nabla^2 V = \frac{1}{\rho} \frac{\partial}{\partial \rho} \left(-\frac{z \cos \phi}{\rho} \right) - \frac{z \cos \phi}{\rho} + 0 = \frac{z \cos \phi}{\rho^3} - \frac{z \cos \phi}{\rho^3} = 0$$

$$(c) \quad V = 30r^{-2} \cos \theta,$$

$$\nabla^2 V = \frac{1}{r^2} \frac{\partial}{\partial r} (-60r^{-1} \cos \theta) + \frac{1}{r^2 \sin \theta} \frac{\partial}{\partial \theta} (-\sin \theta 30r^{-2} \sin \theta) = \frac{60}{r^2} \cos \theta - \frac{30}{r^4 \sin \theta} (2 \sin \theta \cos \theta) = 0$$

Prob. 6.8 If

$$\nabla^2 V = \frac{\partial^2 V}{\partial x^2} + \frac{\partial^2 V}{\partial y^2} + \frac{\partial^2 V}{\partial z^2} = 0$$

then

$$0 = -\frac{\partial}{\partial x} \left(\frac{\partial^2 V}{\partial x^2} + \frac{\partial^2 V}{\partial y^2} + \frac{\partial^2 V}{\partial z^2} \right) = \frac{\partial^2}{\partial x^2} \left(-\frac{\partial V}{\partial x} \right) + \frac{\partial^2}{\partial y^2} \left(-\frac{\partial V}{\partial x} \right) + \frac{\partial^2}{\partial z^2} \left(-\frac{\partial V}{\partial x} \right)$$

or

$$0 = \frac{\partial^2}{\partial x^2} E_x + \frac{\partial^2}{\partial y^2} E_x + \frac{\partial^2}{\partial z^2} E_x = \nabla^2 E_x$$

i.e. $\nabla^2 E_x = 0$.

The same holds for E_y and E_z .

Prob. 6.9

$$\frac{\partial V}{\partial x} = (-A n \sin nx + B n \cos nx)(C e^{ny} + D e^{-ny})$$

$$\frac{\partial^2 V}{\partial x^2} = (-A n^2 \cos nx - n^2 B \sin nx)(C e^{ny} + D e^{-ny}) = -n^2 V$$

$$\frac{\partial V}{\partial y} = (A \cos nx + B \sin nx)(n C e^{ny} - n D e^{-ny})$$

$$\frac{\partial^2 V}{\partial y^2} = n^2 V$$

Thus

$$\nabla^2 V = \frac{\partial^2 V}{\partial x^2} + \frac{\partial^2 V}{\partial y^2} = -n^2 V + n^2 V = \underline{\underline{0}}$$

Prob. 6.10 (a)

$$\frac{\partial V}{\partial x} = 4xyz, \quad \frac{\partial^2 V}{\partial x^2} = 4yz$$

$$\frac{\partial V}{\partial y} = 2x^2z - 3y^2z, \quad \frac{\partial^2 V}{\partial y^2} = -6yz$$

$$\frac{\partial V}{\partial z} = 2x^2y - y^3, \quad \frac{\partial^2 V}{\partial z^2} = 0$$

$$\nabla^2 V = 4yz - 6yz + 0 = -2yz$$

$\nabla^2 V \neq 0$, V does not satisfy Laplace's equation.

(b)

$$\nabla^2 V = -\frac{\rho_v}{\epsilon} = -2yz \quad \longrightarrow \quad \rho_v = 2yz\epsilon$$

$$Q = \int \rho_v dv = \int_0^1 \int_0^1 \int_0^1 (2yz\epsilon) dx dy dz = 2\epsilon(1) \frac{y^2}{2} \Big|_0^1 \frac{z^2}{2} \Big|_0^1 = \epsilon/2 = 2\epsilon_0/2 = \epsilon_0$$

$$\underline{Q = 8.854 \text{ pC}}$$

Prob. 6.11

$$\nabla^2 V = \frac{d^2 V}{dz^2} = 0 \quad \longrightarrow \quad V = Az + B$$

$$\text{When } z=0, V=0 \quad \longrightarrow \quad B=0$$

$$\text{When } z=d, V=V_0 \quad \longrightarrow \quad V_0=Ad \text{ or } A=V_0/d$$

Hence,

$$V = \frac{V_0 z}{d}$$

$$E = -\nabla V = -\frac{dV}{dz} a_z = -\frac{V_0}{d} a_z$$

$$D = \epsilon E = -\epsilon_0 \epsilon_r \frac{V_0}{d} a_z$$

Since $V_0 = 50 \text{ V}$ and $d = 2 \text{ mm}$,

$$\underline{V = 25z \text{ kV}}, \quad \underline{E = -25a_z \text{ kV/m}}$$

$$D = -\frac{10^{-9}}{36\pi} (1.5) 25 \times 10^3 a_z = \underline{\underline{-332 a_z \text{ nC/m}^2}}$$

$$\rho_s = D_n = \underline{\underline{\pm 332 \text{ nC/m}^2}}$$

The surface charge density is positive on the plate at $z=d$ and negative on the plate at $z=0$.

Prob. 6.12 From Example 6.8, solving $\nabla^2 V = 0$ when $V = V(\rho)$ leads to

$$V = \frac{V_0 \ln \rho / a}{\ln b / a}$$

$$E = -\nabla V = -\frac{V_0}{\rho \ln b / a} a_\rho, \quad D = \epsilon E = -\frac{\epsilon_0 \epsilon_r V_0}{\rho \ln b / a} a_\rho$$

$$\rho_s = D_n = \pm \frac{\epsilon_0 \epsilon_r V_0}{\rho \ln b / a} \Big|_{\rho=a,b}$$

In this case, $V_0 = 100 \text{ V}$, $b = 5 \text{ mm}$, $a = 15 \text{ mm}$, $\epsilon_r = 2$. Hence at $\rho = 10 \text{ mm}$,

$$V = \frac{100 \ln 10/5}{\ln 15/5} = \underline{\underline{36.91 \text{ V}}}$$

$$E = -\frac{100}{10 \times 10^{-3} \ln 3} a_\rho = \underline{\underline{-9.102 a_\rho}}$$

$$D = -9.102 \times 10^3 \times \frac{10^{-9}}{36\pi} 2a_\rho = \underline{\underline{-161 a_\rho \text{ nC/m}^2}}$$

$$\rho_s(\rho = 5\text{mm}) = \frac{10^{-9}}{36\pi} (2) \frac{10^5}{5 \ln 3} = \underline{\underline{322 \text{ nC/m}^2}}$$

$$\rho_s(\rho = 15\text{mm}) = -\frac{10^{-9}}{36\pi} (2) \frac{10^5}{15 \ln 3} = \underline{\underline{-107.3 \text{ nC/m}^2}}$$

Prob. 6.13

$$\nabla^2 V = \frac{1}{\rho} \frac{\partial}{\partial \rho} \left(\rho \frac{\partial V}{\partial \rho} \right) = 0 \quad \longrightarrow \quad V = A \ln \rho + B$$

Let ρ be in cm.

$$V(\rho = 2) = 60 \quad \longrightarrow \quad 60 = A \ln 2 + B$$

$$V(\rho = 6) = -20 \quad \longrightarrow \quad -20 = A \ln 6 + B$$

Thus, $A = -72.82$, $B = 110.47$, and

$$V = 110.47 - 72.82 \ln \rho$$

$$E = -\frac{dV}{d\rho} a_\rho = -\frac{A}{\rho} a_\rho = \frac{72.82}{\rho} a_\rho, \quad D = \epsilon_0 E$$

At $\rho = 4$, $\underline{\underline{V = 9.52 \text{ V}}}$, $\underline{\underline{E = 18.21 a_\rho \text{ V/m}}}$

$$D = \epsilon_0 E = \frac{10^{-9}}{36\pi} \times 18.21 a_\rho = 0.161 a_\rho \text{ nC/m}^2$$

Prob. 6.14

$$\nabla^2 V = 0 \quad \longrightarrow \quad V = -A/r + B$$

$$\text{At } r=0.5, V=-50 \quad \longrightarrow \quad -50 = -A/0.5 + B$$

Or

$$-50 = -2A + B \quad (1)$$

$$\text{At } r = 1, V = 50 \longrightarrow 50 = -A + B \quad (2)$$

From (1) and (2), $A = 100$, $B = 150$, and

$$V = -\frac{100}{r} + 150$$

$$E = -\nabla V = -\frac{A}{r^2} a_r = -\frac{100}{r^2} a_r \quad \text{V/m}$$

Prob. 6.15 From Example 6.4,

$$V = \frac{V_o \ln\left(\frac{\tan\theta/2}{\tan\theta_1/2}\right)}{\ln\left(\frac{\tan\theta_2/2}{\tan\theta_1/2}\right)}$$

$$V_o = 100, \quad \theta_1 = 30^\circ, \quad \theta_2 = 120^\circ, \quad r = \sqrt{3^2 + 0^2 + 4^2} = 5, \quad \theta = \tan^{-1} \rho/z = \tan^{-1} 3/4 = 36.87^\circ$$

$$V = 100 \frac{\ln\left(\frac{\tan 18.435^\circ}{\tan 15^\circ}\right)}{\ln\left(\frac{\tan 60^\circ}{\tan 15^\circ}\right)} = \underline{\underline{117 \text{ V}}}$$

$$E = \frac{-V_o a_\theta}{r \sin\theta \ln\left(\frac{\tan\theta_2/2}{\tan\theta_1/2}\right)} = \frac{-100 a_\theta}{5 \sin 36.87^\circ \ln 6.464} = \underline{\underline{-17.86 a_\theta \text{ V/m}}}$$

Prob. 6.16 (a)

$$\nabla^2 V = \frac{1}{\rho} \frac{\partial}{\partial \rho} \left(\rho \frac{\partial V}{\partial \rho} \right) = 0 \longrightarrow V = A \ln \rho + B$$

$$V(\rho = b) = 0 \longrightarrow 0 = A \ln b + B \longrightarrow B = -A \ln b$$

$$V(\rho = a) = V_o \longrightarrow V_o = A \ln a + B \longrightarrow A = \frac{V_o}{\ln b/a}$$

$$V = -\frac{V_o}{\ln b/a} \ln \rho + \frac{V_o \ln b}{\ln b/a}$$

$$V(\rho = 15 \text{ mm}) = 70 \frac{\ln 2}{\ln 50} = \underline{\underline{12.4 \text{ V}}}$$

(b) As the electron decelerates, potential energy gained = K.E. loss

$$e[70 - 12.4] = \frac{1}{2} m [(10^7)^2 - u^2] \quad \longrightarrow \quad 10^{14} - u^2 = \frac{2e}{m} \times 57.6$$

$$u^2 = 10^{14} - \frac{2 \times 1.6 \times 10^{-19}}{9.1 \times 10^{-31}} \times 57.6 = 10^{12} (100 - 20.25)$$

$$\underline{u = 8.93 \times 10^6 \text{ m/s}}$$

Prob. 6.17 (a) For the parallel-plate capacitor,

$$E = -\frac{V_o}{d} a_x$$

From Example 6.11,

$$C = \frac{1}{V_o^2} \int \epsilon |E|^2 dv = \frac{1}{V_o^2} \int \epsilon \frac{V_o^2}{d^2} dv = \frac{\epsilon}{d^2} Sd = \frac{\epsilon S}{d}$$

(b) For the cylindrical capacitor,

$$E = -\frac{V_o}{\rho \ln b/a} a_\rho$$

From Example 6.8,

$$C = \frac{1}{V_o^2} \iiint \frac{\epsilon V_o^2}{(\rho \ln b/a)^2} \rho d\rho d\phi dz = \frac{2\pi\epsilon L}{(\ln b/a)^2} \int_a^b \frac{d\rho}{\rho} = \frac{2\pi\epsilon L}{\ln b/a}$$

(c) For the spherical capacitor,

$$E = \frac{V_o}{r^2 (1/a - 1/b)} a_r$$

From Example 6.10,

$$C = \frac{1}{V_o^2} \iiint \frac{\epsilon V_o^2}{r^4 (1/a - 1/b)^2} r^2 \sin\theta d\theta dr d\phi = \frac{\epsilon}{(1/a - 1/b)^2} 4\pi \int_a^b \frac{dr}{r^2} = \frac{4\pi\epsilon}{\frac{1}{a} - \frac{1}{b}}$$

Prob. 6.18 This is similar to case 1 of Example 6.5.

$$X = c_1 x + c_2, \quad Y = c_3 y + c_4$$

$$\text{But } X(0) = 0 \quad \longrightarrow \quad 0 = c_2, \quad Y(0) = 0 \quad \longrightarrow \quad 0 = c_4$$

Hence,

$$V(x, y) = XY = a_0 xy, \quad a_0 = c_1 c_3$$

$$\text{Also, } V(xy = 4) = 20 \longrightarrow 20 = 4a_0 \longrightarrow a_0 = 5$$

Thus,

$$V(x, y) = 5xy \text{ and } E = -\nabla V = -5ya_x - 5xa_y$$

At $(x, y) = (1, 2)$,

$$\underline{\underline{V = 10 \text{ V, } E = -10a_x - 5a_y \text{ V/m}}}$$

Prob. 6.19 (a) As in Example 6.5, $X(x) = A \sin(\pi x / b)$

For Y,

$$Y(y) = c_1 \cosh(\pi y / b) + c_2 \sinh(\pi y / b)$$

$$Y(a) = 0 \longrightarrow 0 = c_1 \cosh(\pi a / b) + c_2 \sinh(\pi a / b) \longrightarrow c_1 = -c_2 \tanh(\pi a / b)$$

$$V = \sum_{n=1}^{\infty} a_n \sin(\pi x / b) [\sinh(\pi y / b) - \tanh(\pi a / b) \cosh(\pi y / b)]$$

$$V(x, y = 0) = V_0 = -\sum_{n=1}^{\infty} a_n \tanh(\pi a / b) \sin(\pi x / b)$$

$$-a_n \tanh(\pi a / b) = \frac{2}{b} \int_a^b V_0 \sin(\pi y / b) dy = \begin{cases} \frac{4V_0}{\pi}, & n = \text{odd} \\ 0, & n = \text{even} \end{cases}$$

Hence,

$$\begin{aligned} V &= -\frac{4V_0}{\pi} \sum_{n=\text{odd}}^{\infty} \sin(\pi x / b) \left[\frac{\sin(\pi y / b)}{n \tanh(\pi a / b)} - \frac{\cosh(\pi y / b)}{n} \right] \\ &= -\frac{4V_0}{\pi} \sum_{n=\text{odd}}^{\infty} \frac{\sin(\pi x / b)}{n \sinh(\pi a / b)} [\sin(\pi y / b) \cosh(\pi a / b) - \cosh(\pi y / b) \sinh(\pi a / b)] \\ &= -\frac{4V_0}{\pi} \sum_{n=\text{odd}}^{\infty} \frac{\sin(\pi x / b) \sinh[\pi(a - y) / b]}{n \sinh(\pi a / b)} \end{aligned}$$

Alternatively, for Y

$$Y(y) = c_1 \sinh \pi(y - c_2) / b$$

$$Y(a) = 0 \longrightarrow 0 = c_1 \sinh[n\pi(a - c_2)/b] \longrightarrow c_2 = a$$

$$V = \sum_{n=1}^{\infty} b_n \sin(n\pi x/b) \sinh[n\pi(y-a)/b]$$

where

$$b_n = \begin{cases} -\frac{4V_0}{n\pi \sinh(n\pi a/b)}, & n = \text{odd} \\ 0, & n = \text{even} \end{cases}$$

(b) This is the same as Example 6.5 except that we exchange y and x . Hence

$$\underline{\underline{V(x, y) = \frac{4V_0}{\pi} \sum_{n=\text{odd}}^{\infty} \frac{\sin(n\pi y/a) \sinh n\pi x/a}{n \sinh(n\pi b/a)}}}$$

(c) This is the same as part (a) except that we must exchange x and y . Hence

$$\underline{\underline{V(x, y) = \frac{4V_0}{\pi} \sum_{n=\text{odd}}^{\infty} \frac{\sin(n\pi y/b) \sinh[n\pi(a-x)/b]}{n \sinh(n\pi a/b)}}}$$

Prob. 6.20 (a) $X(x)$ is the same as in Example 6.5. Hence

$$V(x, y) = \sum_{n=1}^{\infty} \sin(n\pi x/b) [a_n \sinh(n\pi y/b) + b_n \cosh(n\pi y/b)]$$

At $y=0$, $V = V_1$

$$V_1 = \sum_{n=1}^{\infty} b_n \sin(n\pi x/b) \longrightarrow b_n = \begin{cases} \frac{4V_1}{n\pi}, & n = \text{odd} \\ 0, & n = \text{even} \end{cases}$$

At $y=a$, $V = V_2$

$$V_2 = \sum_{n=1}^{\infty} \sin(n\pi x/b) [a_n \sinh(n\pi a/b) + b_n \cosh(n\pi a/b)]$$

$$a_n \sinh(n\pi a/b) + b_n \cosh(n\pi a/b) = \begin{cases} \frac{4V_2}{n\pi}, & n = \text{odd} \\ 0, & n = \text{even} \end{cases}$$

or

$$a_n = \begin{cases} \frac{4V_2}{n\pi \sinh(n\pi a/b)} (V_2 - V_1 \cosh(n\pi a/b)), & n = \text{odd} \\ 0, & n = \text{even} \end{cases}$$

Alternatively, we may apply superposition principle.

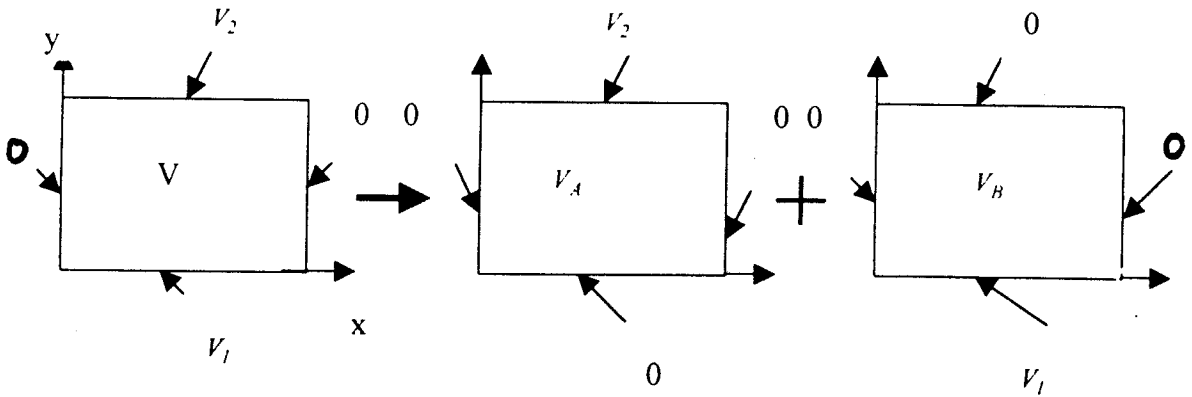

i.e. $V = V_A + V_B$

V_A is exactly the same as Example 6.5 with $V_o = V_2$, while V_B is exactly the same as Prob. 6.19(a). Hence

$$V = \frac{4}{\pi} \sum_{n=\text{odd}}^{\infty} \frac{\sin(n\pi x/b)}{n \sinh(n\pi a/b)} [V_1 \sinh[n\pi(a-y)/b] + V_2 \sinh(n\pi y/b)]$$

(b)

$$V(x, y) = (a_1 e^{-\alpha x} + a_2 e^{+\alpha x})(a_3 \sin \alpha y + a_4 \cos \alpha y)$$

$$\lim_{x \rightarrow \infty} V(x, y) = 0 \quad \longrightarrow \quad a_2 = 0$$

$$V(x, y=0) = 0 \quad \longrightarrow \quad a_4 = 0$$

$$V(x, y=a) = 0 \quad \longrightarrow \quad \alpha = m\pi/a, \quad n = 1, 2, 3, \dots$$

Hence,

$$V(x, y) = \sum_{n=1}^{\infty} a_n e^{-m\pi x/a} \sin(m\pi y/a)$$

$$V(x=0, y) = V_o = \sum_{n=1}^{\infty} a_n \sin(m\pi y/a) \quad \longrightarrow \quad a_n = \begin{cases} \frac{4V_o}{m\pi}, & n = \text{odd} \\ 0, & n = \text{even} \end{cases}$$

$$V(x, y) = \frac{4V_o}{\pi} \sum_{n=\text{odd}}^{\infty} \frac{\sin(m\pi y/a)}{n} \exp(-m\pi x/a)$$

(d) The problem is easily solved using superposition theorem, as illustrated below.

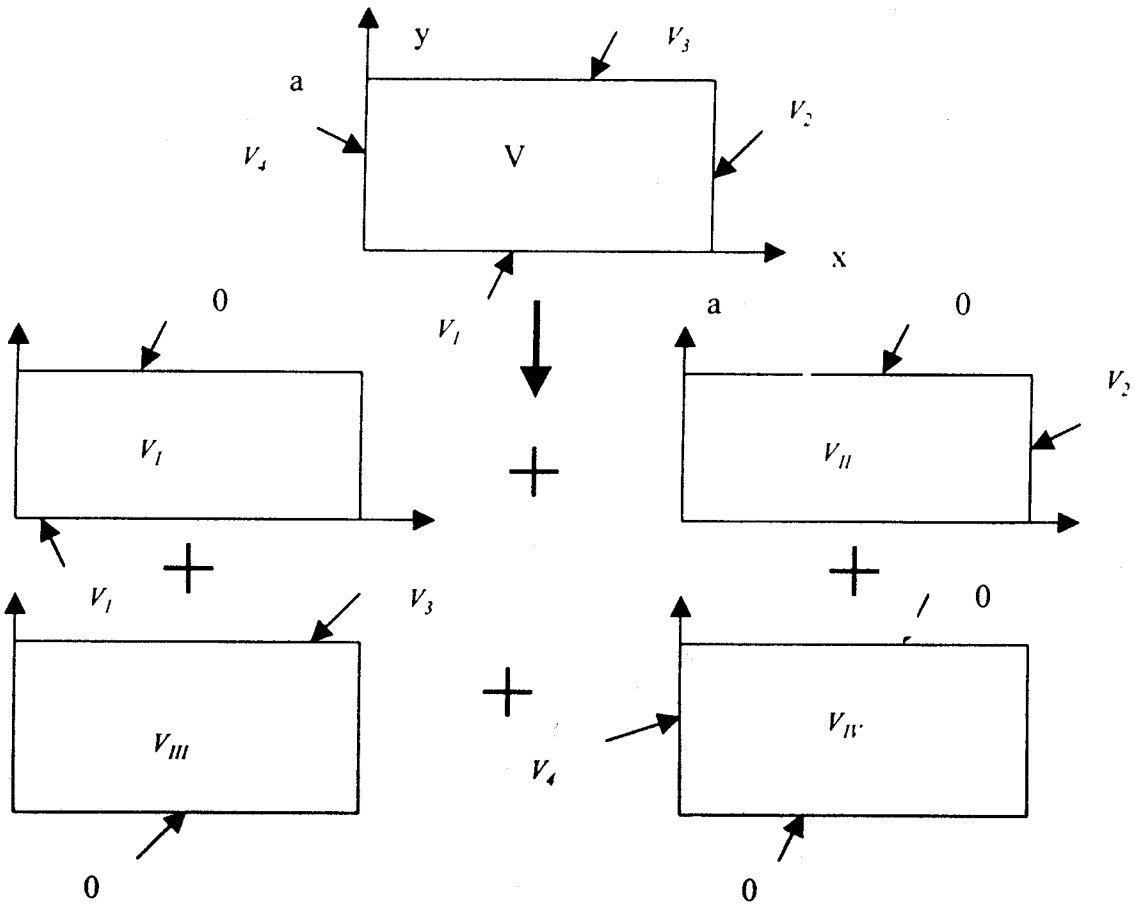

Therefore,

$$V = V_I + V_{II} + V_{III} + V_{IV}$$

where

$$V_I = \frac{4V_1}{\pi} \sum_{n=\text{odd}}^{\infty} \frac{\sin(n\pi x/b) \sinh[n\pi(a-y)/b]}{n \sinh(n\pi a/b)}$$

$$V_{II} = \frac{4V_2}{\pi} \sum_{n=\text{odd}}^{\infty} \frac{\sin(n\pi x/a) \sinh(n\pi y/a)}{n \sinh(n\pi b/a)}$$

$$V_{III} = \frac{4V_3}{\pi} \sum_{n=\text{odd}}^{\infty} \frac{\sin(n\pi x/b) \sinh(n\pi y/b)}{n \sinh(n\pi a/b)}$$

$$V_{IV} = \frac{4V_4}{\pi} \sum_{n=\text{odd}}^{\infty} \frac{\sin(n\pi y/a) \sinh[n\pi(b-x)/a]}{n \sinh(n\pi b/a)}$$

Prob. 6.21

$$\nabla^2 V = \frac{1}{\rho} \frac{\partial}{\partial \rho} \left(\rho \frac{\partial V}{\partial \rho} \right) + \frac{1}{\rho^2} \frac{\partial^2 V}{\partial \phi^2} = 0$$

If we let $V(\rho, \phi) = R(\rho)\Phi(\phi)$,

$$\frac{\Phi}{\rho} \frac{\partial}{\partial \rho} (\rho R') + \frac{1}{\rho^2} R \Phi'' = 0$$

or

$$\frac{\rho}{R} \frac{\partial}{\partial \rho} (\rho R') = -\frac{\Phi''}{\Phi} = \lambda$$

Hence

$$\underline{\Phi'' + \lambda \Phi = 0}$$

and

$$\frac{\partial}{\partial \rho} (\rho R') - \frac{\lambda R}{\rho} = 0$$

or

$$\underline{R'' + \frac{R'}{\rho} - \frac{\lambda R}{\rho^2} = 0}$$

Prob. 6.22

$$\nabla^2 V = \frac{1}{r^2} \frac{\partial}{\partial r} \left(r^2 \frac{\partial V}{\partial r} \right) + \frac{1}{r^2 \sin \theta} \frac{\partial}{\partial \theta} \left(\sin \theta \frac{\partial V}{\partial \theta} \right) = 0$$

If $V(r, \theta) = R(r)F(\theta)$, $r \neq 0$,

$$F \frac{d}{dr} (r^2 R') + \frac{R}{\sin \theta} \frac{d}{d\theta} (\sin \theta F') = 0$$

Dividing through by RF gives

$$\frac{1}{R} \frac{d}{dr} (r^2 R') = -\frac{1}{F \sin \theta} \frac{d}{d\theta} (\sin \theta F') = \lambda$$

Hence,

$$\sin \theta F'' + \cos \theta F' + \lambda F \sin \theta = 0$$

or

$$F'' + \cot \theta F' + \lambda F = 0$$

Also,

$$\frac{d}{dr}(r^2 R') - \lambda R = 0$$

or

$$\underline{R'' + \frac{2R'}{r} - \frac{\lambda}{r^2} R = 0}$$

Prob. 6.23 If the centers at $\phi = 0$ and $\phi = \pi/2$ are maintained at a potential difference of V_0 , from Example 6.3,

$$E_\phi = \frac{2V_0}{\pi\rho}, \quad J = \sigma E$$

Hence,

$$I = \int J \cdot dS = \frac{2V_0\sigma}{\pi} \int_{\rho=a}^b \int_{z=0}^l \frac{1}{\rho} d\rho dz = \frac{2V_0\sigma l}{\pi} \ln(b/a)$$

and

$$R = \frac{V_0}{I} = \frac{\pi}{2\sigma l \ln(b/a)}$$

Prob. 6.24 If $V(r=a) = 0$, $V(r=b) = V_0$, from Example 6.9,

$$E = \frac{V_0}{r^2(1/a - 1/b)}, \quad J = \sigma E$$

Hence,

$$I = \int J \cdot dS = \frac{V_0\sigma}{1/a - 1/b} \int_{\theta=0}^\alpha \int_{\phi=0}^{2\pi} \frac{1}{r^2} r^2 \sin\theta d\theta d\phi = \frac{2\pi V_0\sigma}{1/a - 1/b} (-\cos\theta)|_0^\alpha$$

$$R = \frac{V_0}{I} = \frac{\frac{1}{a} - \frac{1}{b}}{2\pi\sigma(1 - \cos\alpha)}$$

Prob. 6.25 For a spherical capacitor, from Eq. (6.38),

$$R = \frac{\frac{1}{a} - \frac{1}{b}}{4\pi\sigma}$$

For the hemisphere, $R' = 2R$ since the sphere consists of two hemispheres in parallel. As

$b \longrightarrow \infty$,

$$R' = \lim_{b \rightarrow \infty} \frac{1}{\frac{1}{a} - \frac{1}{b}} = \frac{1}{2\pi\sigma}$$

$$G = 1/R' = 2\pi\sigma$$

Alternatively, for an isolated sphere, $C = 4\pi\epsilon a$. But

$$RC = \frac{\epsilon}{\sigma} \longrightarrow R = \frac{1}{4\pi\sigma}$$

$$R' = 2R = \frac{1}{2\pi\sigma} \quad \text{or} \quad G = 2\pi\sigma$$

Prob. 6.26 $l = 1.5\text{mm}$, $S = 3 \times 4 + 1 \times 4 + 3 \times 4 = 28 \text{ cm}^2$

$$R = \frac{l}{\sigma S} = \frac{1.5 \times 10^{-3}}{5.8 \times 10^7 \times 28 \times 10^{-4}} = \underline{\underline{9.236 \text{ n}\Omega}}$$

Prob. 6.27

$$C = \frac{\epsilon S}{d} \longrightarrow S = \frac{Cd}{\epsilon_0 \epsilon_r} = \frac{2 \times 10^{-9} \times 10^{-6}}{4 \times 10^{-9} / 36\pi} \text{ m}^2 = \underline{\underline{0.5655 \text{ cm}^2}}$$

Prob. 6.28

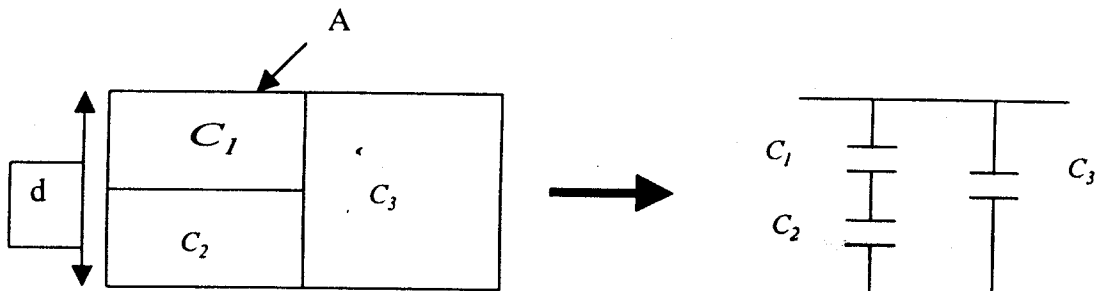

From the figure above,

$$C = \frac{C_1 C_2}{C_1 + C_2} + C_3$$

where

$$C_1 = \frac{\epsilon_0 A / 2}{d/2} = \frac{\epsilon_0 A}{d}, \quad C_2 = \frac{\epsilon_0 \epsilon_r A}{d}, \quad C_3 = \frac{\epsilon_0 A}{2d}$$

$$C = \frac{\epsilon_0^2 \epsilon_r A^2 / d^2}{\epsilon_0 (\epsilon_r + 1) A / d} + \frac{\epsilon_0 A}{2d} = \frac{\epsilon_0 A}{d} \left(\frac{1}{2} + \frac{\epsilon_r}{\epsilon_r + 1} \right) = \frac{10^{-9} 10 \times 10^{-4}}{36\pi 2 \times 10^{-3}} \left(\frac{1}{2} + \frac{6}{7} \right) \cong \underline{\underline{6 \text{ pF}}}$$

Prob. 6.29

$$F dx = dW_E \quad \longrightarrow \quad F = \frac{dW_E}{dx}$$

$$W_E = \int \frac{1}{2} \epsilon |E|^2 dv = \frac{1}{2} \epsilon_0 \epsilon_r E^2 x a d + \frac{1}{2} \epsilon_0 E^2 d a (l - x)$$

where $E = V_0 / d$.

$$\frac{dW_E}{dx} = \frac{1}{2} \epsilon_0 \frac{V_0^2}{d^2} (\epsilon_r - 1) d a \quad \longrightarrow \quad F = \frac{\epsilon_0 (\epsilon_r - 1) V_0^2 a}{2d}$$

Alternatively, $W_E = \frac{1}{2} C V_0^2$, where

$$C = C_1 + C_2 = \frac{\epsilon_0 \epsilon_r a x}{d} + \frac{\epsilon_0 \epsilon_r (l - x)}{d}$$

$$\frac{dW_E}{dx} = \frac{1}{2} \epsilon_0 \frac{V_0^2 a}{d} (\epsilon_r - 1)$$

$$\underline{\underline{F = \frac{\epsilon_0 (\epsilon_r - 1) V_0^2 a}{2d}}}$$

Prob. 6.30 (a)

$$C = \frac{\epsilon_0 S}{d} = \frac{10^{-9} 200 \times 10^{-4}}{36\pi 3 \times 10^{-3}} = 59 \text{ pF}$$

(b) $\rho_s = D_n = 10^{-6} \text{ nC/m}^2$. But

$$D_n = \epsilon E_n = \frac{\epsilon_0 V_0}{d} = \rho_s$$

or

$$V_0 = \frac{\rho_s d}{\epsilon_0} = 10^{-6} \times 3 \times 10^{-3} \times 36\pi \times 10^9 = 339.3 \text{ V}$$

(c)

$$F = \frac{Q^2}{2S\epsilon_0} = \frac{\rho_s^2 S}{2\epsilon_0} = \frac{10^{-12} \times 200 \times 10^{-4} \times 36\pi \times 10^9}{2} = 1.131 \text{ mN}$$

Prob. 6.31

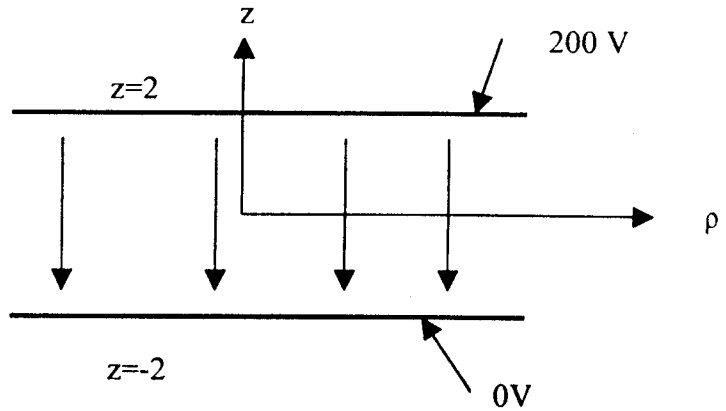

Let z be in cm

$$\frac{d^2V}{dz^2} = 0 \quad \longrightarrow \quad V = Az + B$$

$$\text{When } z = -2, V = 0 \quad \longrightarrow \quad 0 = -2A + B \text{ or } B = 2A$$

$$\text{When } z = 2, V = 200 \quad \longrightarrow \quad 200 = 2A + 2A \quad \longrightarrow \quad A = 50$$

$$V = 50z + 100$$

(a) $V(z=0) = \underline{100 \text{ V}}$

(b) $E = -\nabla V = -Aa_z = -50a_z \text{ V/cm} = -5a_z \text{ kV/m}$

$$\rho_s = D_n = \epsilon E_n = \epsilon E \cdot a_n'$$

At the upper plate ($z=2$), $a_n = -a_z$

$$\begin{aligned} \rho_s &= 5000\epsilon_0\epsilon_r = 5000 \times 2.25 \times \frac{10^{-9}}{36\pi} \\ &= \underline{\underline{99.5 \text{ nC/m}^2}} \end{aligned}$$

At the lower plate ($z = -2$), $a_n = +a_z$

$$\rho_s = \underline{\underline{-99.5 \text{ nC/m}^2}}$$

Prob. 6.32 (a)

$$C = \frac{Q}{V_o} = \frac{\epsilon_o \epsilon_r S}{d} = 5.6 \times \frac{10^{-9}}{36\pi} \times \frac{80 \times 10^{-4}}{6.4 \times 10^{-4}} = \underline{\underline{619 \text{ pF}}}$$

(b)

$$C = \frac{Q}{V_o} \longrightarrow V_o = Q/C$$

$$E = -\nabla V = -3a_x - 4a_y + 12a_z \text{ kV/m} \longrightarrow |E| = \sqrt{3^2 + 4^2 + 12^2} = 13 \text{ kV/m}$$

$$\rho_s = D_n = \epsilon_o |E|$$

Since the entire E is normal to each conducting plate.

$$Q = \rho_s S = \epsilon_o |E| S$$

$$V_o = Q/C = \epsilon_o |E| S \frac{d}{\epsilon_o \epsilon_r S} = \frac{|E| d}{\epsilon_r} = \frac{13 \times 10^3 \times 0.64 \times 10^{-3}}{5.6} = \underline{\underline{14.86 \text{ V}}}$$

Prob. 6.33 (a)

$$C = \frac{4\pi\epsilon}{\frac{1}{a} - \frac{1}{b}} = \frac{4\pi \times 2.25 \times \frac{10^{-9}}{36\pi}}{\frac{1}{5 \times 10^{-2}} - \frac{1}{10 \times 10^{-2}}} = \underline{\underline{25 \text{ pF}}}$$

$$(b) \quad Q = C V_o = 25 \times 80 \text{ pC}$$

$$\rho_s = \frac{Q}{4\pi r^2} = \frac{25 \times 80}{4\pi \times 25 \times 10^{-4}} \text{ pC/m}^2 = \underline{\underline{63.66 \text{ nC/m}^2}}$$

Prob. 6.34 (a)

$$\nabla^2 V = 0 \longrightarrow V = -\frac{A}{r} + B$$

$$\text{When } r=20\text{cm, } V=0 \longrightarrow 0 = -A/0.2 + B \text{ or } B = 5A$$

$$\text{When } r=30\text{cm, } V=50 \longrightarrow 50 = -A/0.3 + 5A \text{ or } A = 30, B = 150$$

$$\underline{\underline{V = -\frac{30}{r} + 150 \text{ V}}}$$

$$E = -\nabla V = -\frac{A}{r^2} a_r = -\frac{30}{r^2} a_r \text{ V/m}$$

$$D = \epsilon_0 \epsilon_0 E = - \frac{30 \times 3.1}{r^2} \times \frac{10^{-9}}{36\pi} a_r = - \frac{0.8223}{r^2} a_r \text{ nC/m}^2$$

$$(b) \quad \rho_s = D_n = D \cdot a_n$$

$$\text{On } r = 30\text{cm, } a_n = -a_r$$

$$\rho_s = \frac{0.8223}{0.3^2} \text{ nC/m}^2 = \underline{\underline{9.137 \text{ nC/m}^2}}$$

$$\text{On } r = 20\text{cm, } a_n = +a_r$$

$$\rho_s = - \frac{0.8223}{0.2^2} \text{ nC/m}^2 = \underline{\underline{-20.56 \text{ nC/m}^2}}$$

(c)

$$R = \frac{\frac{1}{a} - \frac{1}{b}}{4\pi\sigma} = \frac{\frac{1}{0.2} - \frac{1}{0.3}}{4\pi \times 10^{-12}} = \underline{\underline{132.6 \text{ G}\Omega}}$$

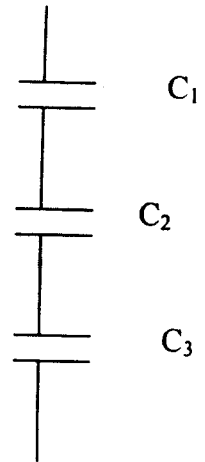
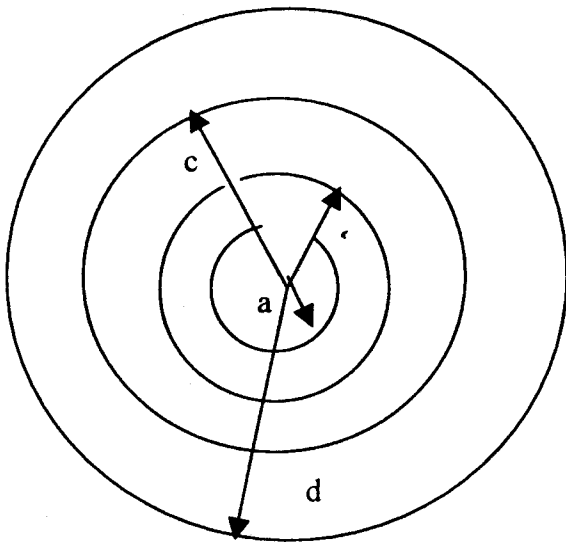
Prob. 6.35

$$\frac{1}{C} = \frac{1}{C_1} + \frac{1}{C_2} + \frac{1}{C_3}$$

$$\text{where } C_1 = \frac{4\pi\epsilon_1}{\frac{1}{c} - \frac{1}{d}}, \quad C_2 = \frac{4\pi\epsilon_2}{\frac{1}{b} - \frac{1}{c}}, \quad C_3 = \frac{4\pi\epsilon_3}{\frac{1}{a} - \frac{1}{b}}$$

$$\frac{4\pi}{C} = \frac{1/c - 1/d}{\epsilon_1} + \frac{1/b - 1/c}{\epsilon_2} + \frac{1/a - 1/b}{\epsilon_3}$$

$$C = \frac{4\pi}{\frac{\epsilon_1}{\frac{1}{c} - \frac{1}{d}} + \frac{\epsilon_2}{\frac{1}{b} - \frac{1}{c}} + \frac{\epsilon_3}{\frac{1}{a} - \frac{1}{b}}}$$

Prob. 6.36

$$C = \frac{4\pi\epsilon}{\frac{1}{a} - \frac{1}{b}}$$

Since $b \rightarrow \infty$,

$$C = 4\pi\epsilon_0\epsilon_r = 4\pi \times 5 \times 10^{-2} \times 80 \times \frac{10^{-9}}{36\pi} = \underline{\underline{444 \text{ pF}}}$$

Prob. 6.37

$$C = \frac{4\pi\epsilon}{\frac{1}{a} - \frac{1}{b}} = \frac{4\pi \times 5.9 \times 10^{-9} / 36\pi}{\left(\frac{1}{2} - \frac{1}{5}\right) \times 10^{-2}} = \underline{\underline{21.85 \text{ pF}}}$$

Prob. 6.38

$$C = \frac{2\pi\epsilon_0 L}{\ln(b/a)} = \frac{2\pi \times \frac{10^{-9}}{36\pi} \times 100 \times 10^{-6}}{\ln(600/20)} = 1.633 \times 10^{-15}$$

$$V = Q/C = \frac{50 \times 10^{-15}}{1.633 \times 10^{-15}} = \underline{\underline{30.62 \text{ V}}}$$

Prob. 6.39 $V = V_0 e^{-t/T_r}$, where $T_r = RC = 10 \times 10^{-6} \times 100 \times 10^6 = 1000$

$$50 = 100 e^{-t/T_r} \quad \longrightarrow \quad 2 = e^{t/T_r}$$

$$t = 1000 \ln 2 = \underline{\underline{693.1 \text{ s}}}$$

Prob. 6.40

$$RC = C/G = \epsilon/\sigma \quad \longrightarrow \quad G = \frac{C\sigma}{\epsilon}$$

$$G = \frac{\pi\sigma}{\cosh^{-1}(d/2a)}$$

Prob. 6.41

$$E = \frac{Q}{4\pi\epsilon r^2} a_r$$

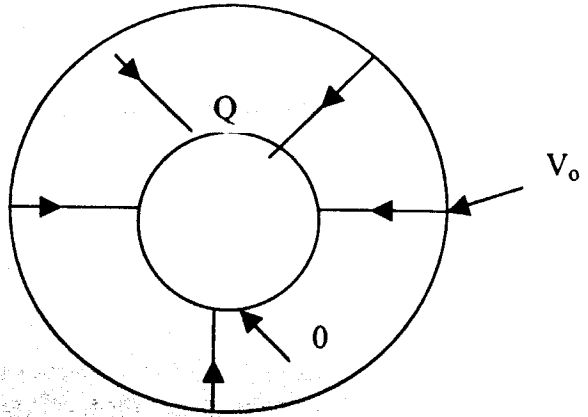

$$W = \frac{1}{2} \int \epsilon |E|^2 dv = \iiint \frac{Q^2}{32\pi^2 \epsilon^2 r^2} \epsilon r^2 \sin\theta d\theta d\phi dr$$

$$= \frac{Q^2}{32\pi^2 \epsilon} (2\pi)(2) \int_b^c \frac{dr}{r^2} = \frac{Q^2}{8\pi\epsilon} \left(\frac{1}{c} - \frac{1}{b} \right)$$

$$W = \frac{Q^2(b-c)}{8\pi\epsilon bc}$$

Prob. 6.42 (a) Method 1: $E = \frac{\rho_s}{\epsilon} (-a_x)$, where ρ_s is to be determined.

$$V_o = - \int E \cdot dl = - \int \frac{-\rho_s}{\epsilon} dx = \rho_s \int_0^d \frac{1}{\epsilon_0} \frac{d}{d+x} dx = \frac{\rho_s}{\epsilon} d \ln(x+d) \Big|_0^d$$

$$V_o = \rho_s d \ln \frac{2d}{d} \quad \longrightarrow \quad \rho_s = \frac{V_o \epsilon_0}{d \ln 2}$$

$$E = - \frac{\rho_s}{\epsilon} a_x = - \frac{V_o}{(x+d) \ln 2} a_x$$

Method 2: We solve Laplace's equation

$$\nabla \cdot (\epsilon \nabla V) = \frac{d}{dx} \left(\epsilon \frac{dV}{dx} \right) = 0 \quad \longrightarrow \quad \epsilon \frac{dV}{dx} = A$$

$$\frac{dV}{dx} = \frac{A}{\epsilon} = \frac{Ad}{\epsilon_0(x+d)} = \frac{c_1}{x+d}$$

$$V = c_1 \ln(x+d) + c_2$$

$$V(x=0) = 0 \quad \longrightarrow \quad 0 = c_1 \ln d + c_2 \quad \longrightarrow \quad c_2 = -c_1 \ln d$$

$$V(x=d) = V_0 \quad \longrightarrow \quad V_0 = c_1 \ln 2d - c_1 \ln d = c_1 \ln 2$$

$$c_1 = \frac{V_0}{\ln 2}$$

$$V = c_1 \ln \frac{x+d}{d} = \frac{V_0}{\ln 2} \ln \frac{x+d}{d}$$

$$E = -\frac{dV}{dx} a_x = -\frac{V_0}{(x+d) \ln 2} a_x$$

$$(b) \quad P = (\epsilon_r - 1) \epsilon_0 E = -\left(\frac{x+d}{d} - 1 \right) \frac{\epsilon_0 V_0}{(x+d) \ln 2} a_x = -\frac{\epsilon_0 x V_0}{d(x+d) \ln 2} a_x$$

(c)

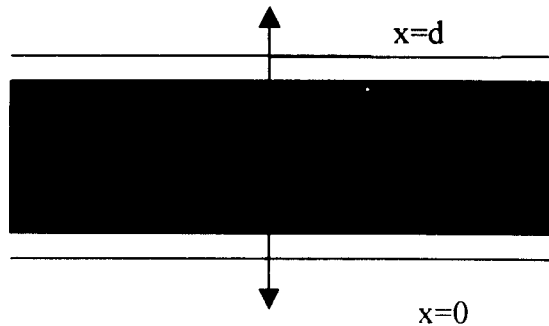

$$\rho_{ps}|_{x=0} = P \cdot (-a_x)|_{x=0} = 0$$

$$\rho_{ps}|_{x=d} = P \cdot a_x|_{x=d} = -\frac{\epsilon_0 V_0}{2d \ln 2}$$

$$(d) \quad Q = \int \rho_s dS = \rho_s S = \frac{\epsilon_0 S V_0}{d \ln 2}$$

$$C = \frac{Q}{V_0} = \frac{\epsilon_0 S}{d \ln 2} = \frac{10^{-9}}{36\pi} \frac{200 \times 10^{-4}}{2.5 \times 10^{-3} \ln 2} = \underline{\underline{102 \text{ pF}}}$$

Prob. 6.43 Method 1: Using Gauss's law,

$$Q = \int D \cdot dS = 4\pi r D_r \quad \longrightarrow \quad D = \frac{Q}{4\pi r^2} a_r$$

$$E = D/\epsilon = \frac{Q}{4\pi \epsilon_0 k} a_r$$

$$V = - \int E \cdot dl = - \frac{Q}{4\pi \epsilon_0 k} \int_a^b \frac{1}{r^2} dr = \frac{Q}{4\pi \epsilon_0 k} (b - a)$$

$$C = \frac{Q}{|V|} = \underline{\underline{\frac{4\pi \epsilon_0 k}{b - a}}}$$

Method 2: Using the inhomogeneous Laplace's equation,

$$\nabla \cdot (\epsilon \nabla V) = 0 \quad \longrightarrow \quad \frac{1}{r^2} \frac{d}{dr} \left(\frac{\epsilon_0 k}{r^2} r^2 \frac{dV}{dr} \right) = 0$$

$$\epsilon_0 k \frac{dV}{dr} = A' \quad \longrightarrow \quad \frac{dV}{dr} = A \text{ or } V = Ar + B$$

$$V(r = a) = 0 \quad \longrightarrow \quad 0 = Aa + B \quad \longrightarrow \quad B = -Aa$$

$$V(r = b) = V_0 \quad \longrightarrow \quad V_0 = Ab + B = A(b - a) \quad \longrightarrow \quad A = \frac{V_0}{b - a}$$

$$E = - \frac{dV}{dr} a_r = -Aa_r = - \frac{V_0}{b - a} a_r$$

$$\rho_s = D_n = - \frac{V_0 \epsilon_0 k}{b - a} \frac{1}{r^2} \Big|_{r=a,b}$$

$$Q = \int \rho_s dS = - \frac{V_0 \epsilon_0 k}{b - a} \iint \frac{1}{r^2} r^2 \sin\theta d\theta d\phi = - \frac{V_0 \epsilon_0 k}{b - a} 4\pi$$

$$C = \frac{|Q|}{V_0} = \underline{\underline{\frac{4\pi \epsilon_0 k}{b - a}}}$$

Prob. 6.44 Method 1: We use Laplace's equation for inhomogeneous medium.

$$\nabla \cdot \nabla V = 0 = \frac{1}{\rho} \frac{d}{d\rho} \left(\rho \epsilon \frac{dV}{d\rho} \right) = 0$$

$$\frac{d}{d\rho} \left(\rho \frac{\epsilon_0 k}{\rho} \frac{dV}{d\rho} \right) = 0$$

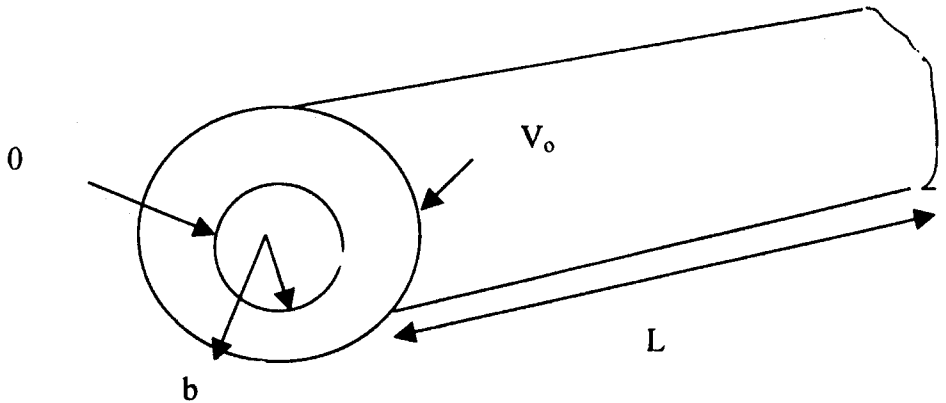

$$\epsilon_0 k \frac{dV}{d\rho} = A' \quad \longrightarrow \quad \frac{dV}{d\rho} = A \quad \text{or} \quad V = A\rho + B$$

$$V(\rho = a) = 0 \quad \longrightarrow \quad 0 = Aa + B \quad \longrightarrow \quad B = -Aa$$

$$V(\rho = b) = V_0 \quad \longrightarrow \quad V_0 = Ab + B = A(b - a) \quad \longrightarrow \quad A = \frac{V_0}{b - a}$$

$$E = -\frac{dV}{dr} a_\rho = -Aa_\rho = -\frac{V_0}{b - a} a_\rho$$

$$\rho_s = D_n = \epsilon E_n$$

On $\rho = b$, $a_n = -a_\rho$

$$\rho_s = \frac{V_0}{b - a} \frac{\epsilon_0 k}{\rho}, \quad dS = \rho d\phi dz$$

$$Q = \int \rho_s ds = \iint \frac{V_0}{b - a} \frac{\epsilon_0 k}{\rho} \rho d\phi dz = 2\pi L \frac{V_0}{b - a} \epsilon_0 k$$

$$C = \frac{Q}{V_o} = \frac{2\pi\epsilon_o kL}{b-a}$$

$$C' = \frac{C}{L} = \frac{2\pi\epsilon_o k}{\underline{\underline{b-a}}}$$

Method 2: We use Gauss's law. Assume Q is on the inner conductor and $-Q$ on the outer conductor.

$$D = \frac{Q}{2\pi L} a_\rho$$

$$E = D/\epsilon = \frac{Q}{2\pi\epsilon_o kL} a_\rho$$

$$V_o = - \int E \cdot dl = - \frac{Q}{2\pi\epsilon_o kL} \int d\rho = - \frac{Q(b-a)}{2\pi\epsilon_o kL}$$

$$C = \frac{Q}{V} = \frac{2\pi\epsilon_o kL}{b-a}$$

$$C' = \frac{C}{L} = \frac{2\pi\epsilon_o k}{\underline{\underline{b-a}}}$$

Prob. 6.45

$$C = 4\pi\epsilon_o a = 4\pi \times \frac{10^{-9}}{36\pi} \times 6.37 \times 10^6 = \underline{\underline{0.708 \text{ mF}}}$$

Prob. 6.46 (a)

$$V = \frac{Q}{4\pi\epsilon_o} \left[\frac{1}{|(6,3,2)|} - \frac{1}{|(6,3,8)|} \right] = \frac{10 \times 10^{-9}}{4\pi \times 10^{-9} / 36\pi} \left[\frac{1}{7} - \frac{1}{\sqrt{109}} \right] = 4.237 \text{ V}$$

$$E = \frac{10 \times 10^{-9}}{4\pi \times 10^{-9} / 36\pi} \left[\frac{(6,3,2)}{7^3} - \frac{(6,3,8)}{109^{3/2}} \right] = \underline{\underline{1.1a_x + 0.55a_y - 0.108a_z \text{ V/m}}}$$

(b)

$$F = \frac{Q_1 Q_2}{4\pi\epsilon_o r^2} a_r = \frac{-10 \times 10 \times 10^{-18} [(0,0,-3) - (0,0,3)]}{4\pi \times \frac{10^{-9}}{36\pi} |(0,0,-3) - (0,0,3)|^3} = -900 \times 10^{-9} \frac{(0,0,-6)}{6^3} = \underline{\underline{-25a_z \text{ N}}}$$

Prob. 6.47

4nC	-3nC	3nC	4nC
4	3	2	1

(a) $Q_i = -(3nC - 4nC) = \underline{1nC}$

(b) The force of attraction between the charges and the plates is

$$F = F_{13} + F_{14} + F_{23} + F_{24}$$

$$|F| = \frac{10^{-18}}{4\pi \times 10^{-9} / 36\pi} \left[\frac{9}{2^2} - \frac{2(12)}{3^2} + \frac{16}{4^2} \right] = \underline{\underline{5.25 \text{ nN}}}$$

Prob. 6.48

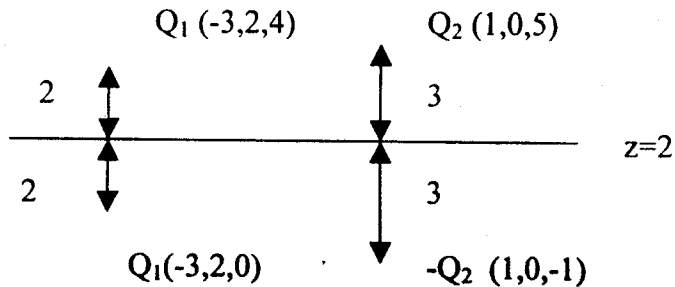

$$\begin{aligned}
 D(x, y, z) &= \frac{Q_1}{4\pi} \left[\frac{(x, y, z) - (-3, 2, 4)}{|(x, y, z) - (-3, 2, 4)|^3} - \frac{(x, y, z) - (-3, 2, 0)}{|(x, y, z) - (-3, 2, 0)|^3} \right] \\
 &\quad + \frac{Q_2}{4\pi} \left[\frac{(x, y, z) - (1, 0, 5)}{|(x, y, z) - (1, 0, 5)|^3} - \frac{(x, y, z) - (1, 0, -1)}{|(x, y, z) - (1, 0, -1)|^3} \right] \\
 &= \frac{50}{4\pi} \left[\frac{(x+3, y-2, z-4)}{|(x+3)^2 + (y-2)^2 + (z-4)^2|^{3/2}} - \frac{(x+3, y-2, z)}{|(x+3)^2 + (y-2)^2 + z^2|^{3/2}} \right] \\
 &\quad - \frac{20}{4\pi} \left[\frac{(x-1, y, z-5)}{|(x-1)^2 + y^2 + (z-5)^2|^{3/2}} - \frac{(x-1, y, z+1)}{|(x-1)^2 + y^2 + (z+1)^2|^{3/2}} \right]
 \end{aligned}$$

(a) At $(x, y, z) = (7, -2, 2)$,

$$\begin{aligned}
 \rho_s = D_z|_{z=2} &= \frac{50}{4\pi} \left[\frac{2-4}{(10^2 + 4^2 + 2^2)^{3/2}} - \frac{2}{(10^2 + 4^2 + 2^2)^{3/2}} \right] \\
 &\quad - \frac{20}{4\pi} \left[\frac{-3}{(6^2 + 4^2 + 3^2)^{3/2}} - \frac{3}{(6^2 + 4^2 + 3^2)^{3/2}} \right] \text{ nC/m}^2
 \end{aligned}$$

$$\underline{\underline{\rho_s = 7.934 \text{ pC/m}^2}}$$

(b) At (3,4,8)

$$D = \frac{50}{4\pi} \left[\frac{(6,2,4)}{(6^2 + 2^2 + 4^2)^{3/2}} - \frac{(6,2,8)}{(6^2 + 2^2 + 8^2)^{3/2}} \right] \\ - \frac{20}{4\pi} \left[\frac{(2,4,3)}{(2^2 + 4^2 + 3^2)^{3/2}} - \frac{(2,4,9)}{(2^2 + 4^2 + 9^2)^{3/2}} \right] \text{ nC/m}^2$$

$$\underline{\underline{D = 17.21a_x - 16.29a_y - 8.486a_z \text{ pC/m}^2}}$$

(c) Since (1,1,1) is below the ground plane, $\underline{\underline{D = 0}}$

Prob. 6.49 We have 7 images as follows: $-Q$ at $(-1,1,1)$, $-Q$ at $(1,-1,1)$, $-Q$ at $(1,1,-1)$, $-Q$ at $(-1,-1,-1)$, Q at $(1,-1,-1)$, Q at $(-1,-1,1)$, and Q at $(-1,1,-1)$. Hence,

$$F = \frac{Q}{4\pi\epsilon_0} \left[-\frac{2}{2^3}a_x - \frac{2}{2^3}a_y - \frac{2}{2^3}a_z - \frac{(2a_x + 2a_y + 2a_z)}{12^{3/2}} + \frac{(2a_y + 2a_z)}{8^{3/2}} + \frac{(2a_x + 2a_z)}{8^{3/2}} + \frac{(2a_x + 2a_y)}{8^{3/2}} \right] \\ = 0.9(a_x + a_y + a_z) \left(-\frac{1}{4} - \frac{1}{12\sqrt{3}} + \frac{1}{4\sqrt{2}} \right) = \underline{\underline{-0.1891(a_x + a_y + a_z) \text{ N}}} \\ +Q$$

Prob. 6.50

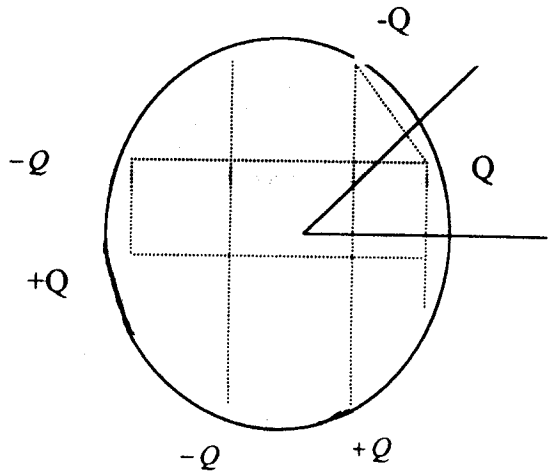

$$N = \left(\frac{360''}{45''} - 1 \right) = 7$$

Prob. 6.51 (a)

$$E = E_+ + E_- = \frac{\rho_L}{2\pi\epsilon_0} \left(\frac{a_{p1}}{\rho_1} - \frac{a_{p2}}{\rho_2} \right) = \frac{16 \times 10^{-9}}{2\pi \times 10^{-9} / 36\pi} \left[\frac{(2, -2, 3) - (3, -2, 4)}{|(2, -2, 3) - (3, -2, 4)|^2} - \frac{(2, -2, 3) - (3, -2, -4)}{|(2, -2, 3) - (3, -2, -4)|^2} \right]$$

$$= 18 \times 16 \left[\frac{(-1, 0, 1)}{2} - \frac{(-1, 0, 7)}{50} \right] = \underline{\underline{-138.2a_x - 184.3a_y \text{ V/m}}}$$

(b) $\rho_s = D_n$

$$D = D_+ + D_- = \frac{\rho_L}{2\pi} \left(\frac{a_{p1}}{\rho_1} - \frac{a_{p2}}{\rho_2} \right) = \frac{16 \times 10^{-9}}{2\pi} \left[\frac{(5, -2, 0) - (3, -2, 4)}{|(5, -2, 0) - (3, -2, 4)|^2} - \frac{(5, -6, 0) - (3, -2, -4)}{|(5, -6, 0) - (3, -2, -4)|^2} \right]$$

$$= \frac{8}{\pi} \left[\frac{(2, 0, -4)}{20} - \frac{(2, 0, 4)}{20} \right] \text{ nC/m}^2 = -1.018a_z \text{ nC/m}^2$$

$$\underline{\underline{\rho_s = -1.018 \text{ nC/m}^2}}$$

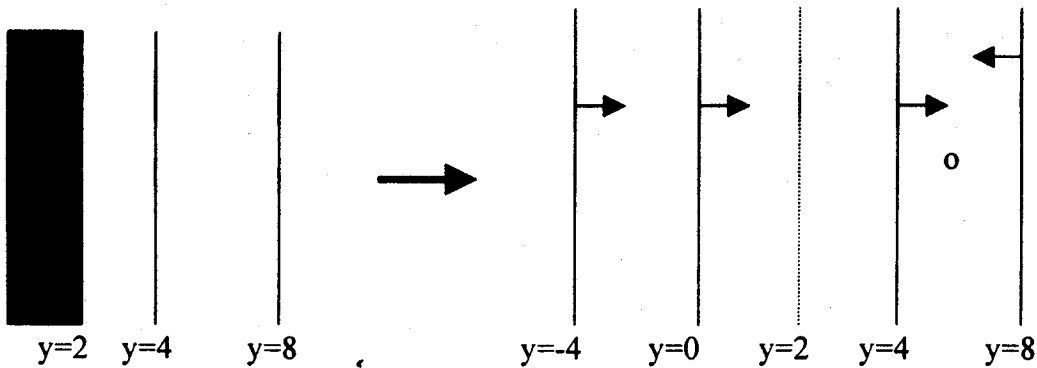
Prob. 6.52

At $P(0,0,0)$, $\underline{\underline{E=0}}$ since E does not exist for $y < 2$.

At $Q(-4,6,2)$, $y=6$ and

$$E = \sum \frac{\rho_s}{2\epsilon_0} a_n = \frac{10^{-9}}{2 \times 10^{-9} / 36\pi} (-30a_y + 20a_y + 20a_y + 30a_y) = \underline{\underline{2.262a_y \text{ kV/m}}}$$

CHAPTER 7

P.E. 7.1

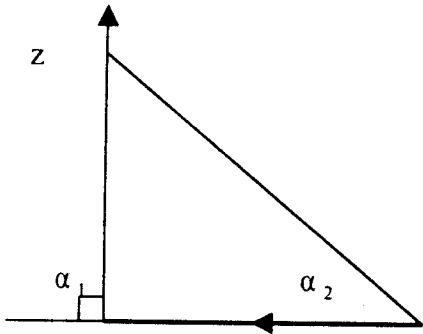

$$\rho = 5, \cos \alpha_1 = 0, \cos \alpha_2 = \sqrt{\frac{2}{27}}$$

$$\mathbf{a}_\phi = \mathbf{a}_1 \times \mathbf{a}_\rho = \left(\frac{-\mathbf{a}_x - \mathbf{a}_y}{\sqrt{2}} \right) \times \mathbf{a}_z = \frac{-\mathbf{a}_x - \mathbf{a}_y}{\sqrt{2}}$$

$$H_3 = \frac{10}{4\pi(5)} \left(\sqrt{\frac{2}{27}} - 0 \right) \left(\frac{-\mathbf{a}_x + \mathbf{a}_y}{2} \right) = \underline{\underline{-30.03\mathbf{a}_x + 30.6\mathbf{a}_y}} \text{ mA/m}$$

P.E. 7.2

$$(a) \mathbf{H} = \frac{2}{4\pi(2)} \left(1 + \frac{3}{\sqrt{13}} \right) \mathbf{a}_z = \underline{\underline{0.1458}} \text{ A/m}$$

$$(b) \rho = \sqrt{3^2 + 4^2} = 5, \alpha_2 = 0, \cos \alpha_1 = -\frac{12}{13},$$

$$\mathbf{a}_\phi = \mathbf{a}_y \times \left(\frac{3\mathbf{a}_x - 4\mathbf{a}_z}{5} \right) = \frac{4\mathbf{a}_x + 3\mathbf{a}_z}{5}$$

$$\begin{aligned} \mathbf{H} &= \frac{2}{4\pi(5)} \left(1 + \frac{12}{13} \right) \left(\frac{4\mathbf{a}_x + 3\mathbf{a}_z}{5} \right) = \frac{1}{26\pi} (4\mathbf{a}_x + 3\mathbf{a}_z) \\ &= \underline{\underline{48.97\mathbf{a}_x + 36.73\mathbf{a}_z}} \text{ mA/m} \end{aligned}$$

P.E. 7.3

(a) From Example 7.3,

$$H = \frac{Ia^2}{2(a^2 + z^2)^{3/2}} \mathbf{a}_z$$

At (0,0,1), $z = 2\text{cm}$,

$$H = \frac{50 \times 10^{-3} \times 25 \times 10^{-4}}{2(5^2 + 2^2)^{3/2} \times 10^{-6}} \mathbf{a}_z \text{ A/m}$$

$$= 400.2\mathbf{a}_z \text{ A/m}$$

(b) At $(0,0,10\text{cm})$, $z = 9\text{cm}$,

$$H = \frac{50 \times 10^{-3} \times 25 \times 10^{-4}}{2(5^2 + 9^2)^{3/2} \times 10^{-6}} a_z$$

$$= \underline{57.3 a_z \text{ mA/m}}$$

P.E. 7.4

$$H = \frac{NI}{2L} (\cos\theta_2 - \cos\theta_1) a_z = \frac{2 \times 10^3 \times 50 \times 10^{-3} (\cos\theta_2 - \cos\theta_1) a_z}{2 \times 0.75}$$

$$= \frac{100}{1.5} (\cos\theta_2 - \cos\theta_1) a_z$$

(a) At $(0,0,0)$, $\theta = 90^\circ$, $\cos\theta_2 = \frac{0.75}{\sqrt{0.75^2 + 0.05^2}}$
 $= 0.9978$

$$H = \frac{100}{1.5} (0.9978 - 1) a_z$$

$$= \underline{66.52 a_z \text{ A/m}}$$

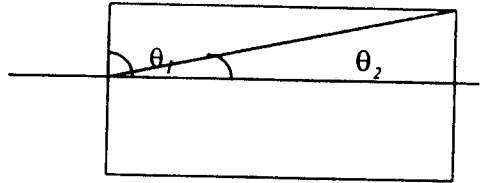

(b) At $(0,0,0.75)$, $\theta_2 = 90^\circ$, $\cos\theta_1 = -0.9978$

$$H = \frac{100}{1.5} (0 + 0.9978) a_z$$

$$= \underline{66.52 a_z \text{ A/m}}$$

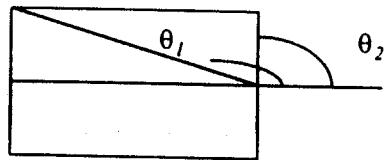

(c) At $(0,0,0.5)$, $\cos\theta_1 = \frac{-0.5}{\sqrt{0.5^2 + 0.05^2}} = -0.995$

$$\cos\theta_2 = \frac{0.25}{\sqrt{0.25^2 + 0.05^2}} = 0.9806$$

$$H = \frac{100}{1.5} (0.9806 + 0.995) a_z$$

$$= \underline{131.7 a_z \text{ A/m}}$$

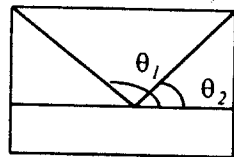

P.E. 7.5

$$H = \frac{I}{2} k \times a_n$$

(a) $H(0,0,0) = \frac{I}{2} 50 a_z \times (-a_y) = \underline{25 a_x \text{ mA/m}}$

(b) $H(1.5,-3) = \frac{I}{2} 50 a_z \times a_y = \underline{-25 a_x \text{ mA/m}}$

P.E. 7.6

$$|H| = \begin{cases} \frac{NI}{2\pi\rho} \cdot \rho - a \langle \rho \langle \rho + a = a \langle \rho \langle 11 \\ 0, & \text{otherwise} \end{cases}$$

(a) At $(3, -4, 0)$, $\rho = \sqrt{3^2 + 4^2} = 5 \text{ cm} < 9 \text{ cm}$

$$|H| = \underline{\underline{0}}$$

(b) At $(6, 9, 0)$, $\rho = \sqrt{6^2 + 9^2} = \sqrt{117} < 11$

$$|H| = \frac{10^3 \times 100 \times 10^{-3}}{2\pi \sqrt{117} \times 10^2} = \underline{\underline{147.1 \text{ A/m}}}$$

P.E. 7.7

(a) $\mathbf{B} = \nabla \times \mathbf{A} = (-4xz - 0)\mathbf{a}_x + (0 + 4yz)\mathbf{a}_y + (y^2 - x^2)\mathbf{a}_z$

$$\mathbf{B}(-1, 2, 5) = \underline{\underline{20\mathbf{a}_x + 40\mathbf{a}_y + 3\mathbf{a}_z \text{ Wb/m}^2}}$$

(b) $\psi = \int \mathbf{B} \cdot \partial \mathbf{s} = \int_{y=1}^4 \int_{x=0}^1 (y^2 - x^2) \partial x \partial y = \int_{-1}^4 y^2 \partial y - 5 \int_0^1 x^2 \partial x$

$$= \frac{1}{3}(64 + 1) - \frac{5}{3} = \underline{\underline{20 \text{ Wb}}}$$

Alternatively,

$$\psi = \int \mathbf{A} \cdot \partial \mathbf{l} = \int_0^1 x^2 (-1) \partial x + \int_{-1}^4 y^2 (1) \partial y + \int_1^0 x^2 (4) \partial x + 0$$

$$= -\frac{5}{3} + \frac{65}{3} = \underline{\underline{20 \text{ Wb}}}$$

P.E. 7.8

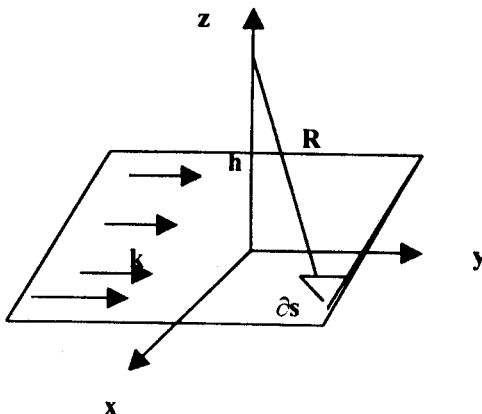

$$\mathbf{H} = \int \frac{\mathbf{k} \hat{\mathbf{c}} \mathbf{s} \times \mathbf{R}}{4\pi R^3}$$

$$\partial s = \partial x \partial y, \mathbf{k} = k_y \mathbf{a}_y.$$

$$\mathbf{R} = (-x, -y, h),$$

$$\mathbf{k} \times \mathbf{R} = (h\mathbf{a}_x + x\mathbf{a}_z)k_y,$$

$$\mathbf{H} = \int \frac{k_y(h\mathbf{a}_x + x\mathbf{a}_z)\partial x \partial y}{4\pi(x^2 + y^2 + h^2)^{3/2}} = \frac{k_y h \mathbf{a}_x}{4\pi} \int_{-x}^x \int_{-x}^x \frac{\partial x \partial y}{(x^2 + y^2 + h^2)^{3/2}} + \frac{k_y \mathbf{a}_z}{4\pi} \int_{-x}^x \int_{-x}^x \frac{x \partial x \partial y}{(x^2 + y^2 + h^2)^{3/2}}$$

The integrand in the last term is zero because it is an odd function of x .

$$\begin{aligned} H &= \frac{k_y h \mathbf{a}_x}{4\pi} \int_{\phi=0}^{2\pi} \int_{\rho=0}^x \frac{\rho \partial \phi \partial \rho}{(\rho^2 + h^2)^{3/2}} = \frac{k_y h 2\pi \mathbf{a}_x}{4\pi} \int_0^x (\rho^2 + h^2)^{-3/2} \frac{\partial(\rho^2)}{2} \\ &= \frac{k_y h}{2} \mathbf{a}_x \left(\frac{-1}{(\rho^2 + h^2)^{1/2}} \right) \Big|_0^x = \frac{k_y}{2} \mathbf{a}_x \end{aligned}$$

Similarly, for point $(0, 0, -h)$, $\mathbf{H} = -\frac{1}{2} k_y \mathbf{a}_x$

Hence,

$$\mathbf{H} = \begin{cases} \frac{1}{2} k_y \mathbf{a}_x, & z > 0 \\ -\frac{1}{2} k_y \mathbf{a}_x, & z < 0 \end{cases}$$

Prob. 7.1

(a) See text

(b) Let $\mathbf{H} = H_y + H_z$

$$\text{For } \mathbf{H}_z = \frac{\mathbf{I}}{2\pi\rho} \mathbf{a}_\phi, \quad \rho = \sqrt{(-3)^2 + 4^2} = 5$$

$$\mathbf{a}_\phi = -\mathbf{a}_z \times \frac{(-3\mathbf{a}_x + 4\mathbf{a}_y)}{5} = \frac{(3\mathbf{a}_y - 4\mathbf{a}_x)}{5}$$

$$\mathbf{H}_z = \frac{20}{2\pi(25)} (4\mathbf{a}_x + 3\mathbf{a}_y) = 0.5093\mathbf{a}_x + 0.382\mathbf{a}_y$$

$$\text{For } \mathbf{H}_y = \frac{\mathbf{I}}{2\pi\rho} \mathbf{a}_\phi, \quad \rho = \sqrt{(-3)^2 + 5^2} = \sqrt{34}$$

$$\mathbf{a}_\phi = \mathbf{a}_y \times \frac{(-3\mathbf{a}_x + 5\mathbf{a}_z)}{\sqrt{34}} = \frac{3\mathbf{a}_z - 5\mathbf{a}_x}{\sqrt{34}}$$

$$\mathbf{H}_y = \frac{10}{2\pi(34)} (-5\mathbf{a}_x + 3\mathbf{a}_z) = -0.234\mathbf{a}_x + 0.140\mathbf{a}_z$$

$$\mathbf{H} = H_y + H_z$$

$$= 0.2753\mathbf{a}_x + 0.382\mathbf{a}_y + 0.1404\mathbf{a}_z \text{ A/m}$$

Prob. 7.2

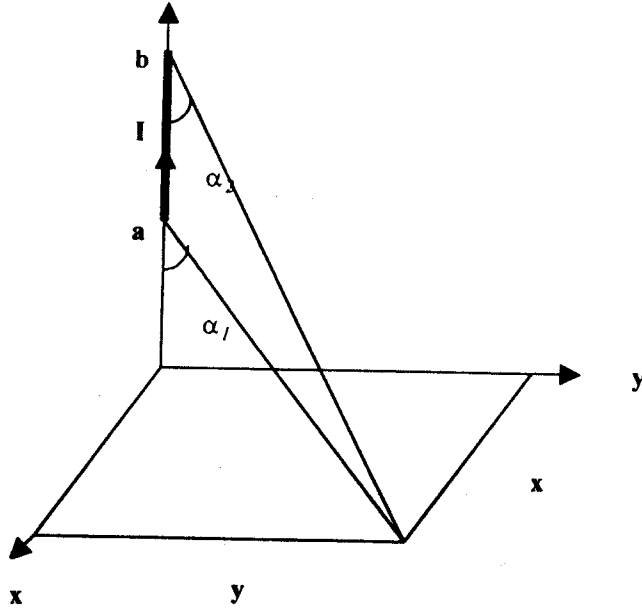

$$H = \frac{I}{4\pi\rho} (\cos\alpha_2 - \cos\alpha_1)\mathbf{a}_\phi$$

$$\rho = \sqrt{x^2 + y^2}, \cos\alpha_1 = \frac{a}{\sqrt{a^2 + \rho^2}}, \cos\alpha_2 = \frac{b}{\sqrt{b^2 + \rho^2}}$$

$\mathbf{a}_\rho = \mathbf{a}_1 \times \mathbf{a}_\rho = \mathbf{a}_z \times \mathbf{a}_\rho$ i.e. \mathbf{a}_ϕ is regular \mathbf{a}_ϕ . Hence,

$$H = \left[\frac{I}{4\pi\sqrt{x^2 + y^2 + b^2}} - \frac{a}{\sqrt{x^2 + y^2 + a^2}} \right] \mathbf{a}_\phi$$

Prob. 7.3

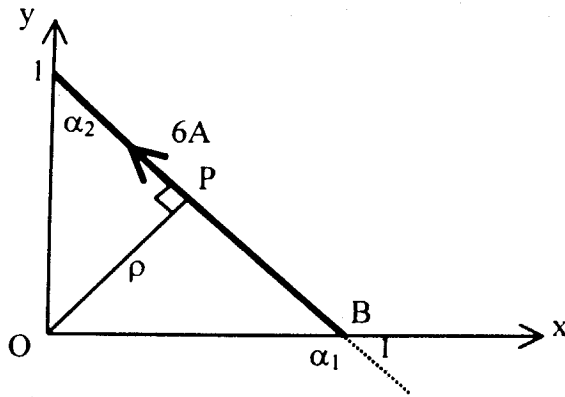

$$\vec{H} = \frac{I}{4\pi\rho} (\cos\alpha_2 - \cos\alpha_1) \vec{a}_\rho$$

$$\alpha_1 = 135^\circ, \alpha_2 = 45^\circ, \rho = \frac{1}{2}\sqrt{2} = \frac{\sqrt{2}}{2}$$

$$\vec{a}_\rho = \vec{a}_1 \times \vec{a}_2 = \left(\frac{-\vec{a}_x + \vec{a}_y}{\sqrt{2}} \right) \times \left(\frac{-\vec{a}_x - \vec{a}_y}{\sqrt{2}} \right) = \frac{1}{2} \begin{vmatrix} -1 & 1 & 0 \\ -1 & -1 & 0 \end{vmatrix} = \vec{a}_z$$

$$\vec{H} = \frac{6}{4\pi \frac{\sqrt{2}}{2}} (\cos 45^\circ - \cos 135^\circ) \vec{a}_z = \frac{3}{\pi} \vec{a}_z$$

$$\vec{H}(0,0,0) = \underline{\underline{0.954 \vec{a}_z \text{ A/m}}}$$

Prob. 7.4

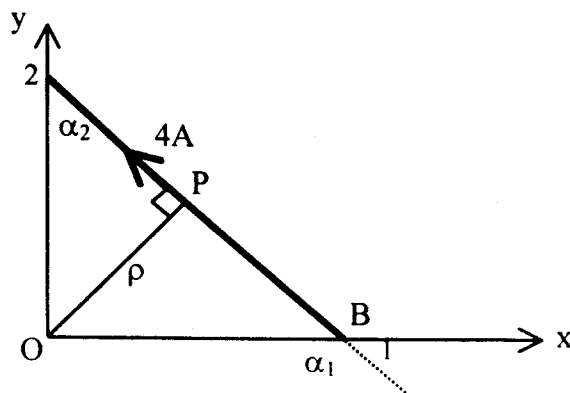

$$\bar{H} = \frac{I}{4\pi\rho}(\cos\alpha_2 - \cos\alpha_1)\bar{a}_\phi$$

$$\begin{aligned}\cos\alpha_2 &= \frac{2}{\sqrt{5}}, \quad \cos(180 - \alpha_1) = \frac{1}{\sqrt{5}} = \cos 180^\circ \cos\alpha_1 + \sin 180^\circ \sin\alpha_1 \\ &= -\cos\alpha_1, \quad \cos\alpha_1 = -\frac{1}{\sqrt{5}}\end{aligned}$$

$$OP = (x-0, y-0) = x\bar{a}_x + y\bar{a}_y$$

$$AB = -\bar{a}_x + 2\bar{a}_y$$

But on AB, $y = 2(1-x)$

$$OP \cdot AB = 0 = -x + 2y = -x + 4(1-x) = 4 - 5x$$

$$x = 0.8, \quad y = 0.4, \quad \rho = |OP| = 0.4\sqrt{5}$$

$$\bar{a}_p = \bar{a}_1 \times \bar{a}_p = \left(\frac{-\bar{a}_x + 2\bar{a}_y}{5} \right) \times \left(\frac{-0.8\bar{a}_x - 0.4\bar{a}_y}{0.4\sqrt{5}} \right) = \bar{a}_z$$

$$\bar{H} = \frac{4}{4\pi(0.4\sqrt{5})} \left[\frac{2}{\sqrt{5}} + \frac{1}{\sqrt{5}} \right] \bar{a}_z = \frac{3}{2\pi} \bar{a}_z = \underline{\underline{0.4775 \bar{a}_z \text{ A/m}}}$$

Prob. 7.5

$$\begin{aligned}\text{(a)} \quad \bar{H} &= \frac{I}{4\pi\rho}(\cos\alpha_2 - \cos\alpha_1)\bar{a}_\phi = \frac{2}{4\pi(5)} \left(\frac{10}{5\sqrt{2}} - 0 \right) \bar{a}_y \\ &= \underline{\underline{28.47 \bar{a}_y \text{ mA/m}}}\end{aligned}$$

$$\begin{aligned}\text{(b)} \quad \bar{H} &= \frac{2}{4\pi(5\sqrt{2})} \left(\frac{10}{5\sqrt{6}} - 0 \right) \bar{a}_\phi, \quad \text{where } \bar{a}_\phi = \bar{a}_z \times \left(\frac{\bar{a}_x + \bar{a}_y}{\sqrt{2}} \right) \\ &= \frac{1}{5\pi\sqrt{2}} \left(\frac{-\bar{a}_x + \bar{a}_y}{\sqrt{2}} \right) = \underline{\underline{-13\bar{a}_x + 13\bar{a}_y \text{ mA/m}}}\end{aligned}$$

$$\begin{aligned}\text{(c)} \quad \bar{H} &= \frac{2}{4\pi(5)\sqrt{10}} \left(\frac{10}{5\sqrt{14}} - 0 \right) \bar{a}_\phi, \quad \bar{a}_\phi = \bar{a}_z \times \left(\frac{\bar{a}_x + 3\bar{a}_y}{\sqrt{10}} \right) \\ &= \frac{1}{50\pi\sqrt{14}} (-3\bar{a}_x + \bar{a}_y) = -5.1\bar{a}_x + 1.7\bar{a}_y \text{ mA/m} \\ &= \underline{\underline{28.47 \bar{a}_x \text{ mA/m}}}\end{aligned}$$

$$\underline{\underline{-5.1 \bar{a}_x + 1.7 \bar{a}_y}}$$

(d) $H = 5.1a_x + 1.7a_y \text{ mA/m}^2$

Prob. 7.6

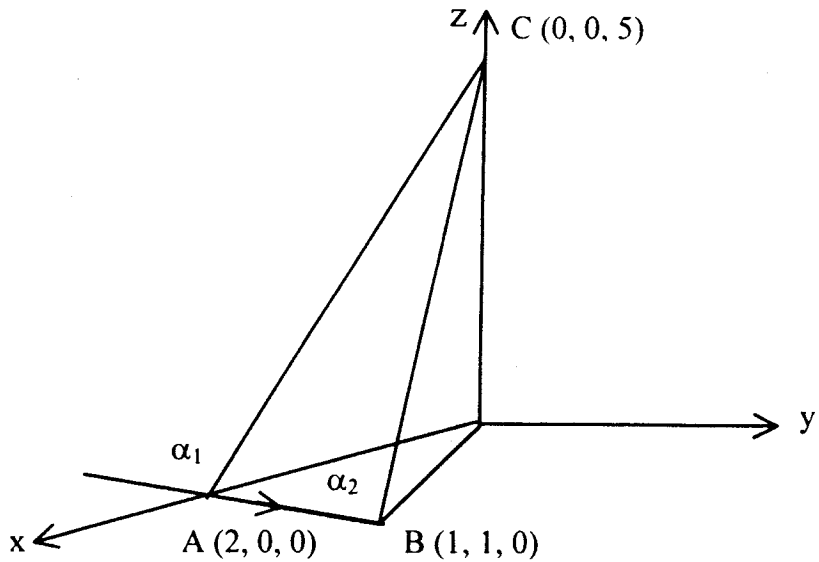

(a) Consider the figure above.

$$\overline{AB} = (1, 1, 0) - (2, 0, 0) = (-1, 1, 0)$$

$$\overline{AC} = (0, 0, 5) - (2, 0, 0) = (-2, 0, 5)$$

$\overline{AB} \cdot \overline{AC} = 2$, i.e. AB and AC are not perpendicular.

$$\cos(180^\circ - \alpha_1) = \frac{\overline{AB} \cdot \overline{AC}}{|\overline{AB}| |\overline{AC}|} = \frac{2}{\sqrt{2} \sqrt{29}} \rightarrow \cos \alpha_1 = -\sqrt{\frac{2}{29}}$$

$$\overline{BC} = (0, 0, 5) - (-1, -1, 5) = (-1, -1, 5)$$

$$\overline{BA} = (1, -1, 0)$$

$$\cos \alpha_2 = \frac{\overline{BC} \cdot \overline{BA}}{|\overline{BC}| |\overline{BA}|} = \frac{-1+1}{|\overline{BC}| |\overline{BA}|} = 0$$

i.e. $\overline{BC} = \vec{\rho} = (-1, -1, 5), \rho = \sqrt{27}$

$$\vec{a}_\phi = \vec{a}_1 \times \vec{a}_\rho = \frac{(-1, 1, 0)}{\sqrt{2}} \times \frac{(-1, -1, 5)}{\sqrt{27}} = \frac{(5, 5, 2)}{\sqrt{54}}$$

$$\begin{aligned} \vec{H}_2 &= \frac{10}{4\pi\sqrt{27}} \left(0 + \sqrt{\frac{2}{29}} \right) \frac{(5, 5, 2)}{\sqrt{27}} = \frac{5}{2\pi\sqrt{29}} \cdot \frac{(5, 5, 2)}{27} \text{ A/m} \\ &= \underline{\underline{27.37 \vec{a}_x + 27.37 \vec{a}_y + 10.95 \vec{a}_z \text{ mA/m}}} \end{aligned}$$

(b) $\vec{H} = \vec{H}_1 + \vec{H}_2 + \vec{H}_3 = (0, -59.1, 0) + (27.37, 27.37, 10.95)$
 $+ (-30.63, 30.63, 0)$
 $= \underline{\underline{-3.26 \vec{a}_x - 1.1 \vec{a}_y + 10.95 \vec{a}_z \text{ mA/m}}}$

Prob. 7.7

(a) Let $\bar{H} = \bar{H}_x + \bar{H}_y = 2\bar{H}_x$

$$\bar{H}_x = \frac{I}{4\pi\rho} (\cos\alpha_2 - \cos\alpha_1) \bar{a}_x$$

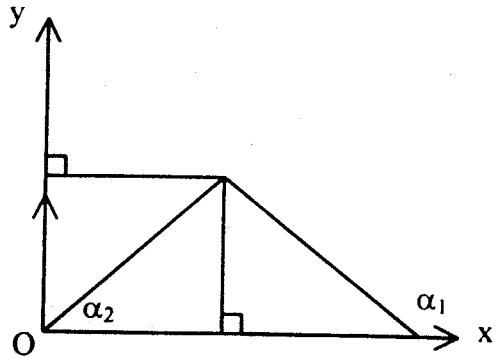

where $\bar{a}_\phi = -\bar{a}_x \times \bar{a}_y = -\bar{a}_z$, $\alpha_1 = 180^\circ$, $\alpha_2 = 45^\circ$

$$\begin{aligned}\bar{H}_x &= \frac{5}{4\pi(2)}(\cos 45^\circ - \cos 180^\circ)(-\bar{a}_z) \\ &= \underline{\underline{-0.6792 \bar{a}_z \text{ A/m}}}\end{aligned}$$

(b) $\bar{H} = \bar{H}_x + \bar{H}_y$

where $\bar{H}_x = \frac{5}{4\pi(2)}(1-0)\bar{a}_\phi$, $\bar{a}_\phi = -\bar{a}_x \times -\bar{a}_y = \bar{a}_z$

$$= 198.9 \bar{a}_z \text{ MA/m}$$

$\bar{H}_y = 0$ since $\alpha_1 = \alpha_2 = 0$

$\bar{H} = \underline{\underline{0.1989 \bar{a}_z \text{ A/m}}}$

(c) $\bar{H} = \bar{H}_x + \bar{H}_y$

where $\bar{H}_x = \frac{5}{4\pi(2)}(1-0)(-\bar{a}_x \times \bar{a}_z) = 198.9 \bar{a}_y \text{ MA/m}$

$\bar{H}_y = \frac{5}{4\pi(2)}(1-0)(\bar{a}_y \times \bar{a}_z) = 198.9 \bar{a}_x \text{ MA/m}$

$\bar{H} = \underline{\underline{0.1989 \bar{a}_x + 0.1989 \bar{a}_y \text{ A/m}}}$

Prob. 7.8

For the side of the loop along y - axis,

$$\bar{H}_1 = \frac{I}{4\pi\rho}(\cos \alpha_2 - \cos \alpha_1)\bar{a}_\phi$$

where $\bar{a}_\phi = -\bar{a}_x$, $\rho = 2 \tan 30^\circ = \frac{2}{\sqrt{3}}$, $\alpha_2 = 30^\circ$, $\alpha_1 = 150^\circ$

$$\bar{H}_1 = \frac{5}{4\pi} \frac{2}{\sqrt{3}}(\cos 30^\circ - \cos 150^\circ)(-\bar{a}_x) = -\frac{15}{8\pi} \bar{a}_x$$

$\bar{H} = 3\bar{H}_1 = -1.79 \bar{a}_x \text{ A/m}$

Prob. 7.9

$$\text{Let } \vec{H} = \vec{H}_1 + \vec{H}_2 + \vec{H}_3 + \vec{H}_4$$

where \vec{H}_n is the contribution by side n .

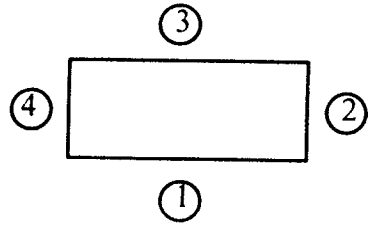

(a) $\vec{H} = 2\vec{H}_1 + \vec{H}_2 + \vec{H}_4$ since $\vec{H}_1 = \vec{H}_3$

$$\vec{H}_1 = \frac{I}{4\pi\rho}(\cos\alpha_2 - \cos\alpha_1)\vec{a}_\phi = \frac{10}{4\pi(2)}\left(\frac{6}{\sqrt{40}} + \frac{1}{\sqrt{2}}\right)\vec{a}_z$$

$$\vec{H}_2 = \frac{10}{4\pi(6)}\left(2 \times \frac{2}{\sqrt{40}}\right)\vec{a}_z, \quad \vec{H}_4 = \frac{10}{4\pi(2)}\left(2 \cdot \frac{1}{\sqrt{2}}\right)\vec{a}_z$$

$$\vec{H} = \left[\frac{5}{2\pi} \left(\frac{3}{\sqrt{10}} + \frac{1}{\sqrt{2}} \right) + \frac{5}{6\pi\sqrt{10}} + \frac{5}{2\pi\sqrt{2}} \right] \vec{a}_z = \underline{\underline{1.964 \vec{a}_z \text{ A/m}}}$$

(b) At $(4, 2, 0)$, $\vec{H} = 2(\vec{H}_1 + \vec{H}_4)$

$$\vec{H}_1 = \frac{10}{4\pi(2)} \frac{8}{\sqrt{20}} \vec{a}_z, \quad \vec{H}_4 = \frac{10}{4\pi(4)} \frac{4}{\sqrt{20}} \vec{a}_z$$

$$\vec{H} = \frac{2\sqrt{5}}{\pi} \left(1 + \frac{1}{4} \right) \vec{a}_z = \underline{\underline{1.78 \vec{a}_z \text{ A/m}}}$$

(c) At $(4, 8, 0)$, $\vec{H} = \vec{H}_1 + 2\vec{H}_2 + \vec{H}_3$

$$\vec{H}_1 = \frac{10}{4\pi(8)} \left(2 \cdot \frac{4}{4\sqrt{5}} \right) \vec{a}_z, \quad \vec{H}_2 = \frac{10}{4\pi(4)} \left(\frac{8}{4\sqrt{5}} - \frac{1}{\sqrt{2}} \right) \vec{a}_z$$

$$\vec{H}_3 = \frac{10}{4\pi(4)} \left(\frac{2}{\sqrt{2}} \right) (-\vec{a}_z)$$

$$\vec{H} = \frac{5}{8\pi} (\vec{a}_z) \left(\frac{1}{\sqrt{5}} + \frac{4}{\sqrt{5}} - \frac{4}{\sqrt{2}} \right) = \underline{\underline{-0.1178 \vec{a}_z \text{ A/m}}}$$

(d) At $(0, 0, 2)$,

$$\vec{H}_1 = \frac{10}{4\pi(22)} \left(\frac{8}{\sqrt{64}} - 0 \right) (\vec{a}_x \times \vec{a}_z) = -\frac{10}{\pi\sqrt{64}} \vec{a}_y$$

$$\vec{H}_2 = \frac{10}{4\pi\sqrt{64}} \left(\frac{4}{\sqrt{84}} - 0 \right) \vec{a}_y \times \left(\frac{2\vec{a}_x - 8\vec{a}_x}{\sqrt{68}} \right) = \frac{5(\vec{a}_x + 4\vec{a}_y)}{17\pi\sqrt{84}}$$

$$\bar{H}_3 = \frac{10}{4\pi\sqrt{20}} \left(-\frac{8}{\sqrt{84}} - 0 \right) \bar{a}_x \times \left(\frac{2\bar{a}_x - 8\bar{a}_y}{\sqrt{20}} \right) = \frac{\bar{a}_y + 2\bar{a}_z}{\pi\sqrt{21}}$$

$$\bar{H}_4 = \frac{10}{4\pi\sqrt{2}} \left(0 + \frac{4}{\sqrt{20}} \right) (-\bar{a}_y \times \bar{a}_z) = \frac{-5\bar{a}_x}{\pi\sqrt{20}}$$

$$\begin{aligned} \bar{H} &= \left(\frac{1}{34\pi\sqrt{21}} - \frac{5}{\pi\sqrt{20}} \right) \bar{a}_x + \left(\frac{1}{\pi\sqrt{21}} - \frac{10}{\pi\sqrt{68}} \right) \bar{a}_y + \left(\frac{20}{34\pi\sqrt{21}} - \frac{2}{\pi\sqrt{21}} \right) \bar{a}_z \\ &= \underline{\underline{-0.3457 \bar{a}_x - 0.3165 \bar{a}_y + 0.1798 \bar{a}_z \text{ A/m}}} \end{aligned}$$

Prob. 7.10

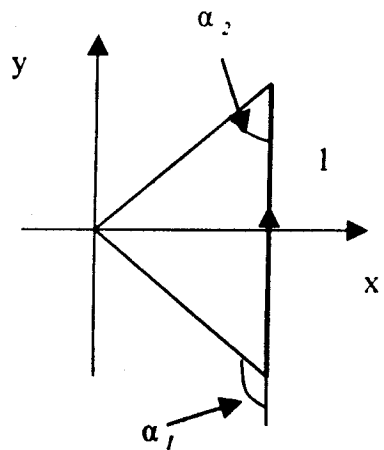
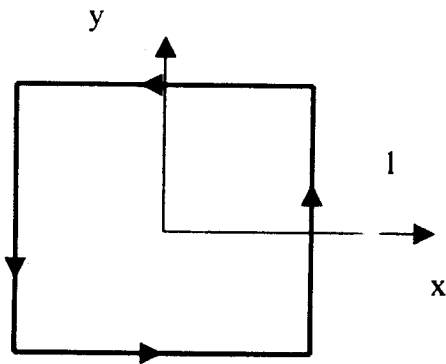

$H = 4H_1$, where H_1 is due to side 1.

$$H_1 = \frac{I}{4\pi\rho} (\cos\alpha_2 - \cos\alpha_1) \mathbf{a}_\phi$$

$$\rho = a, \quad \alpha_2 = 45^\circ, \quad \alpha_1 = 135^\circ, \quad \mathbf{a}_\phi = \mathbf{a}_y x - \mathbf{a}_x = \mathbf{a}_z$$

$$H_1 = \frac{I}{4\pi\rho} \left(\frac{1}{\sqrt{2}} + \frac{1}{\sqrt{2}} \right) \mathbf{a}_z = \frac{2I}{4\pi a\sqrt{2}} \mathbf{a}_z$$

Prob. 7.11

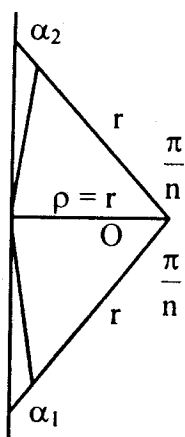

- (a) Consider one side of the polygon as shown. The angle subtended by the Side At the center of the circle is

$$\frac{360^\circ}{n} = \frac{2\pi}{n}$$

The field due to this side is

$$H_1 = \frac{I}{4\pi\rho} (\cos \alpha_2 - \cos \alpha_1)$$

$$\text{where } \rho = r, \cos \alpha_2 = \left(\cos 90 - \frac{\pi}{n} \right) = \sin \frac{\pi}{n}$$

$$\cos \alpha_1 = -\sin \frac{\pi}{n}$$

$$H_1 = \frac{I}{4\pi r} 2 \sin \frac{\pi}{n}$$

$$\bar{H} = n\bar{H}_1 = \frac{nI}{2\pi r} \sin \frac{\pi}{n}$$

(b) For $n = 3$, $H = \frac{3I}{2\pi r} \sin \frac{\pi}{3}$

$$r \cot 30^\circ = 2 \rightarrow r = \frac{2}{\sqrt{3}}$$

$$H = \frac{3 \times 5}{2\pi \cdot \frac{2}{\sqrt{3}}} \cdot \frac{\sqrt{3}}{2} = \frac{48}{8\pi} = 1.78 \text{ A/m.}$$

$$\text{For } n = 4, H = \frac{4I}{2\pi r} \sin \frac{\pi}{4} = \frac{4 \times 5}{2\pi(2)} \cdot \frac{1}{\sqrt{2}} = 1.128 \text{ A/m.}$$

- (c) As $n \rightarrow \infty$,

$$H = \lim_{n \rightarrow \infty} \frac{nI}{2\pi r} \sin \frac{\pi}{n} = \frac{nI}{2\pi r} \cdot \frac{\pi}{n} = \frac{I}{2r}$$

From Example 7.3, when $h = 0$,

$$H = \frac{I}{2r}$$

which agrees.

Prob. 7.12

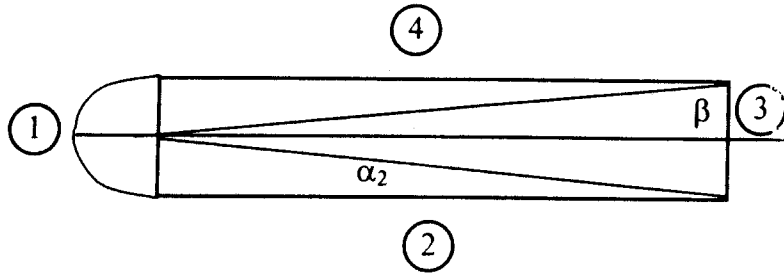

$$\text{Let } \bar{H} = \bar{H}_1 + \bar{H}_2 + \bar{H}_3 + \bar{H}_4$$

$$\bar{H}_1 = \frac{I}{4a} \bar{a}_z = \frac{10}{4 \times 4 \times 10^{-2}} \bar{a}_z = 62.5 \bar{a}_z$$

$$\begin{aligned} \bar{H}_2 = \bar{H}_4 &= \frac{I}{4 \times 4 \times 10^{-2}} (\cos \alpha_2 - \cos 90^\circ) \bar{a}_z, \quad \alpha_2 = \tan^{-1} \frac{4}{100} = 2.29^\circ \\ &= 19.99 \bar{a}_z \end{aligned}$$

$$\begin{aligned} \bar{H}_3 &= \frac{I}{4\pi(1)} 2 \cos \beta \bar{a}_z, \quad \beta = \tan^{-1} \frac{100}{4} = 87.7^\circ \\ &= \frac{10}{4\pi} 2 \cos 87.7^\circ \bar{a}_z = 0.06361 \bar{a}_z \end{aligned}$$

$$\begin{aligned} \bar{H} &= (62.5 + 2 \times 19.88 + 0.06361) \bar{a}_z \\ &= 120.32 \bar{a}_z \text{ A/m.} \end{aligned}$$

Prob. 7.13

From Example 7.3, \bar{H} due to circular loop is

$$\bar{H}_1 = \frac{I\rho^2}{2(\rho^2 + z^2)} \bar{a}_z$$

$$\begin{aligned} \text{(a) } \bar{H}(0, 0, 0) &= \frac{5 \times 2^2}{2(2^2 + 0^2)^{3/2}} \bar{a}_z + \frac{5 \times 2^2}{2(2^2 + 4^2)^{3/2}} \bar{a}_z \\ &= 1.36 \bar{a}_z \text{ A/m} \end{aligned}$$

$$\begin{aligned} \text{(b) } \bar{H}(0, 0, 2) &= 2 \frac{5 \times 2^2}{2(2^2 + 2^2)^{3/2}} \bar{a}_z \\ &= 0.884 \bar{a}_z \text{ A/m} \end{aligned}$$

Prob. 7.14

$$\bar{B} = \mu_0 \bar{H} = \frac{\mu_0 N I}{L}$$

$$N = \frac{B l}{\mu \cdot I} = \frac{5 \times 10^{-3} \times 3 \times 10^{-2}}{4\pi \times 10^{-7} \times 400 \times 10^{-3}} = 29.84$$

$N \approx 30$ turns.

Prob. 7.15

(a)

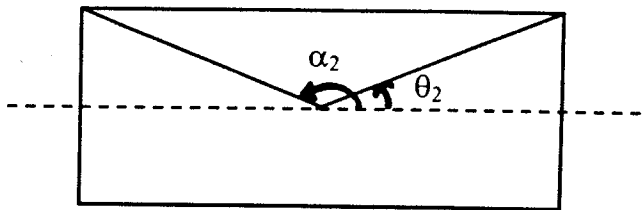

$$|\bar{H}| = \frac{nl}{2} (\cos \theta_2 - \cos \theta_1)$$

$$\cos \theta_2 = -\cos \theta_1 = \frac{1/2}{(a^2 + l^2/4)^{1/2}}$$

$$|\bar{H}| = \frac{nl}{2(a^2 + l^2/4)^{1/2}} = \frac{0.5 \times 150 \times 2 \times 10^{-2}}{2 \times 10^{-3} \times \sqrt{4^2 + 10^2}} = \underline{\underline{69.63 \text{ A/m}}}$$

(b)

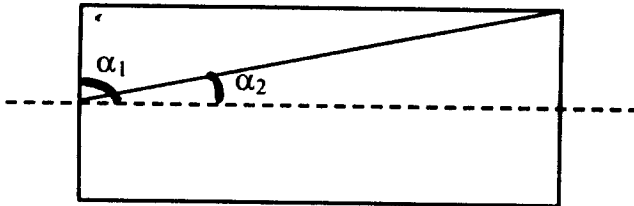

$$\alpha_1 = 90^\circ, \tan \theta_2 = \frac{a}{b} = \frac{4}{20} = 0.2 \rightarrow \theta_2 = 11.31^\circ$$

$$|\bar{H}| = \frac{nl}{2} \cos \theta_2 = \frac{150 \times 0.5}{2} \cos 11.31^\circ = \underline{\underline{36.77 \text{ A/m}}}$$

Prob. 7.16

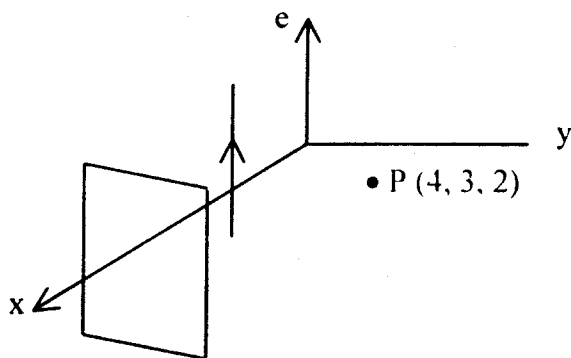

$$\text{Let } \bar{H} = \bar{H}_1 + \bar{H}_p$$

$$\bar{H}_1 = \frac{1}{2\pi\rho} \bar{a}_\phi$$

$$\bar{\rho} = (4, 3, 2) - (1, -2, 2) = (1, 5, 0), \quad \rho = |\bar{\rho}| = \sqrt{26}$$

$$\bar{a}_\rho = \frac{\bar{a}_x + 5\bar{a}_y}{\sqrt{26}}, \quad \bar{a}_1 = \bar{a}_z$$

$$\bar{a}_\phi = \bar{a}_1 \times \bar{a}_\rho = \bar{a}_z \times \left(\frac{\bar{a}_x + 5\bar{a}_y}{\sqrt{26}} \right) = \frac{\bar{a}_y - 5\bar{a}_x}{\sqrt{26}}$$

$$\bar{H}_1 = \frac{20\pi}{2\pi} \left(\frac{-5\bar{a}_x + \bar{a}_y}{26} \right) = -1.923 \bar{a}_x + 0.3846 \bar{a}_y$$

$$\bar{H}_p = \frac{1}{2} \bar{k} \times \bar{a}_n = \frac{1}{2} (100 \times 10^{-3}) \bar{a}_z \times (\bar{a}_x) = -0.05 \bar{a}_y$$

$$\bar{H} = \bar{H}_1 + \bar{H}_p = \underline{\underline{-1.923 \bar{a}_x - 0.3346 \bar{a}_y \text{ A/m}}}$$

Prob. 7.17 (a) See text.

(b)

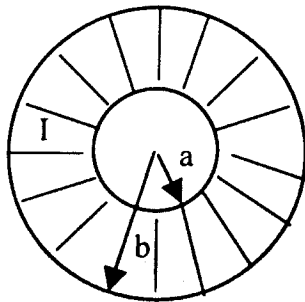

$$\text{For } \rho < a, \oint \vec{H} \cdot d\vec{l} = I_{\text{enc}} = 0 \rightarrow \vec{H} = 0$$

$$\text{For } 0 < \rho < b, H_{\phi} \cdot 2\pi\rho = \frac{I\pi(\rho^2 - a^2)}{\pi(b^2 - a^2)}$$

$$H_{\phi} = \frac{I}{2\pi\rho} \left(\frac{\rho^2 - a^2}{b^2 - a^2} \right)$$

$$\text{For } \rho > b, H_{\phi} \cdot 2\pi\rho = I \rightarrow \vec{H}_{\phi} = \frac{I}{2\pi\rho}$$

Thus,

$$H_{\phi} = \begin{cases} 0, & \rho < a \\ \frac{I}{2\pi\rho} \left(\frac{\rho^2 - a^2}{b^2 - a^2} \right), & a < \rho < b \\ \frac{I}{2\pi\rho}, & \rho > b \end{cases}$$

Prob. 7.18

(a) Applying Ampere's law,

$$H_{\phi} \cdot 2\pi\rho = I \cdot \frac{\pi\rho^2}{\pi a^2} \rightarrow H_{\phi} = I \cdot \frac{\rho^2}{2\pi a^2}$$

$$\text{i.e. } \vec{H} = \frac{I\rho}{2\pi a^2} \vec{a}_{\phi}$$

$$\vec{j} = \nabla \cdot \vec{H} = -\frac{\partial H_{\phi}}{\partial z} \vec{a}_{\rho} + \frac{I}{\rho} \frac{\partial}{\partial \rho} (\rho H_{\phi}) \vec{a}_z$$

$$= \frac{I}{\rho} \frac{1}{2\pi a^2} \cdot \underline{\underline{2\rho \vec{a}_z}} = \underline{\underline{\frac{I}{\pi a^2} \vec{a}_z}}$$

(b) From Prob. 7.15,

$$H_{\phi} = \begin{cases} \frac{I\rho}{2\pi a^2}, & \rho < a \\ \frac{I}{2\pi\rho}, & \rho > a \end{cases}$$

At (0, 1 cm, 0),

$$H_{\phi} = \frac{3 \times 1 \times 10^{-2}}{2\pi \times 4 \times 10^{-4}} = \frac{300}{8\pi}$$

$$\underline{\underline{\bar{H} = 11.94 \bar{a}_{\phi} \text{ A/m}}}$$

At (0, 4 cm, 0),

$$H_{\phi} = \frac{3}{2\pi \times 4 \times 10^{-2}} = \frac{300}{8\pi}$$

$$\underline{\underline{\bar{H} = 11.94 \bar{a}_{\phi} \text{ A/m}}}$$

Prob. 7.19

$$(a) \quad \bar{J} = \nabla \cdot \bar{H} = \begin{vmatrix} \frac{\partial}{\partial x} & \frac{\partial}{\partial y} & \frac{\partial}{\partial z} \\ y & -x & 0 \end{vmatrix}$$

$$\bar{J} = \underline{\underline{-2 \bar{a}_z \text{ A/m}^2}}$$

$$(b) \quad \oint \bar{H} \cdot d\bar{l} = I_{\text{enc}}$$

$$I_{\text{enc}} = \int \bar{J} \cdot d\bar{s} = \int_{x=0}^3 \int_{y=-1}^4 (-2) dx dy = (-2)(3)(5) = -30 \text{ A}$$

$$\begin{aligned} \oint \bar{H} \cdot d\bar{l} &= \int_0^3 y dy \Big|_{y=-1} + \int_{y=-1}^4 (-x) dy \Big|_{x=3} + \int y dx \Big|_{y=4} \\ &+ \int_{x=0}^3 (-x) dy \Big|_{x=0} = (-1)(3) + (-3)(5) + (4)(-3) \\ &= -30 \text{ A} \end{aligned}$$

$$\text{Thus, } \oint \bar{H} \cdot d\bar{l} = I_{\text{enc}} = \underline{\underline{-30 \text{ A}}}$$

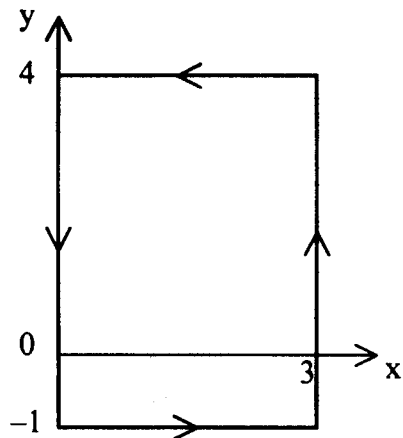

Prob. 7.20

$$(a) \quad \bar{J} = \nabla \times \bar{H} = \begin{vmatrix} \frac{\partial}{\partial x} & \frac{\partial}{\partial y} & \frac{\partial}{\partial z} \\ yz(x^2 + y^2) & -y^2xz & -4x^2y^2 \end{vmatrix}$$

$$= (8x^2y + xy^2)\bar{a}_x + [y(x^2 + y^2) - 4xy^2]\bar{a}_y$$

$$+ [-y^2z - z(x^2 + y^2)]\bar{a}_z$$

At (5, 2, -3), $x = 5$, $y = 2$, $z = -3$

$$\bar{J} = \underline{\underline{420\bar{a}_x - 22\bar{a}_y + 99\bar{a}_z \text{ A/m}^2}}$$

$$(b) \quad I = \int \bar{J} \cdot d\bar{S} = \iint (8x^2y + xy^2) dydz \Big|_{x=-1}$$

$$= \int_0^2 dz \int_0^2 (8y - y^2) dy = 2 \left(4y^2 - \frac{y^3}{3} \right) \Big|_0^2$$

$$= 4 \left(16 - \frac{8}{3} \right) = 53.33 \text{ A}$$

$$(c) \quad \bar{B} = \mu\bar{H}, \quad \nabla \cdot \bar{B} = 0 \rightarrow \nabla \cdot \bar{H} = 0$$

$$\nabla \cdot \bar{H} = \frac{\partial}{\partial x} H_x + \frac{\partial}{\partial y} H_y + \frac{\partial}{\partial z} H_z = 2xy - 2yxz = 0$$

$$\text{Hence } \underline{\underline{\nabla \cdot \bar{B} = 0}}$$

Prob. 7.21

$$(a) \quad \bar{B} = \frac{\mu_0 I}{2\pi\ell} \bar{a}_\phi. \quad \text{At } (-3, 4, 5), \rho = 5$$

$$\bar{B} = \frac{4\pi \times 10^{-7} \times 2}{2\pi(5)} \bar{a}_\phi = 80\bar{a}_\phi \text{ nWb/m}^2$$

$$(b) \quad \phi = \int \bar{B} \cdot d\bar{S} = \frac{\mu_0 I}{2\pi} \iint \frac{d\rho dz}{\rho}$$

$$= \frac{4\pi \times 10^{-7} \times 2}{2\pi} \ln \rho \Big|_2^6 z \Big|_0^4 = 16 \times 10^{-7} \ln 3$$

$$= \underline{\underline{1.756 \mu\text{Wb}}}$$

Prob. 7.22

$$\psi = \int \bar{\mathbf{B}} \cdot d\bar{\mathbf{s}} = \mu_0 \int_{z=0}^{0.2} \int_{\phi=0}^{90^\circ} \frac{10^6}{\rho} \sin 2\phi \rho \, d\phi \, dz$$

$$\begin{aligned} \psi &= 4\pi \times 10^{-7} \times 10^6 (0.2) \left(-\frac{\cos 2\phi}{2} \right) \Big|_0^{90^\circ} \\ &= 0.04\pi (1 - \cos 180^\circ) \\ &= \underline{\underline{0.1475 \text{ Wb}}} \end{aligned}$$

Prob. 7.23

$$\text{Let } \bar{\mathbf{H}} = \bar{\mathbf{H}}_1 + \bar{\mathbf{H}}_2$$

where $\bar{\mathbf{H}}_1$ and $\bar{\mathbf{H}}_2$ are due to the wires centered at $x = 0$ and $x = 10\text{cm}$ respectively.

(a) For $\bar{\mathbf{H}}_1$, $\rho = 50 \text{ cm}$, $\bar{\mathbf{a}}_\phi = \bar{\mathbf{a}}_1 \times \bar{\mathbf{a}}_\rho = \bar{\mathbf{a}}_z \times \bar{\mathbf{a}}_x = \bar{\mathbf{a}}_y$

$$\bar{\mathbf{H}}_1 = \frac{5}{2\pi(5 \times 10^{-2})} \bar{\mathbf{a}}_y = \frac{50}{\pi} \bar{\mathbf{a}}_y$$

For $\bar{\mathbf{H}}_2$, $\rho = 5 \text{ cm}$, $\bar{\mathbf{a}}_\phi = -\bar{\mathbf{a}}_z \times -\bar{\mathbf{a}}_x = \bar{\mathbf{a}}_y$, $\bar{\mathbf{H}}_2 = \bar{\mathbf{H}}_1$

$$\bar{\mathbf{H}} = 2\bar{\mathbf{H}}_1 = \frac{100}{\pi} \bar{\mathbf{a}}_y$$

$$= 31.43 \bar{\mathbf{a}}_y \text{ A/m}$$

(b) For $\bar{\mathbf{H}}_1$, $\bar{\mathbf{a}}_\phi = \bar{\mathbf{a}}_z \times \left(\frac{2\bar{\mathbf{a}}_x + \bar{\mathbf{a}}_y}{\sqrt{5}} \right) = \frac{2\bar{\mathbf{a}}_y - \bar{\mathbf{a}}_x}{\sqrt{5}}$

$$\bar{\mathbf{H}}_1 = \frac{5}{2\pi 5\sqrt{5} \times 10^{-2}} \left(\frac{-\bar{\mathbf{a}}_x + 2\bar{\mathbf{a}}_y}{\sqrt{5}} \right) = -3.183 \bar{\mathbf{a}}_x + 6.366 \bar{\mathbf{a}}_y$$

For $\bar{\mathbf{H}}_2$, $\bar{\mathbf{a}}_\phi = -\bar{\mathbf{a}}_z \times \bar{\mathbf{a}}_y = \bar{\mathbf{a}}_x$

$$\bar{\mathbf{H}}_2 = \frac{5}{2\pi(5)} \bar{\mathbf{a}}_x = 15.924 \bar{\mathbf{a}}_x$$

$$\bar{\mathbf{H}} = \bar{\mathbf{H}}_1 + \bar{\mathbf{H}}_2$$

$$= 12.79 \bar{\mathbf{a}}_x + 6.366 \bar{\mathbf{a}}_y \text{ A/m}$$

Prob. 7.24

$$\bar{B} = \frac{\mu_0 I}{2\pi\rho} \bar{a}_\phi$$

$$\begin{aligned} \psi &= \bar{B} \cdot d\bar{s} = \int_{\rho=d}^{d+a} \int_{z=0}^b \frac{\mu_0 I}{2\pi\rho} d\rho dz \\ &= \frac{\mu_0 I b}{2\pi} \ln \frac{d+a}{d} \end{aligned}$$

Prob. 7.25

On the slant side of the ring, $z = \frac{h}{6}(\rho - a)$

where \bar{H}_1 and \bar{H}_2 are due to the wires centered at $x = 0$ and $x = 10\text{cm}$ respectively.

$$\begin{aligned} \psi &= \int \bar{B} \cdot d\bar{s} = \int \frac{\mu_0 I}{2\pi\rho} d\rho dz \\ &= \frac{\mu_0 I}{2\pi\rho} \int_{\rho=a}^{a+b} \int_{z=0}^h \frac{dz d\rho}{\rho} = \frac{\mu_0 I h}{2\pi b} \int_{\rho=a}^{a+b} \left(1 - \frac{a}{\rho}\right) d\rho \\ &= \frac{\mu_0 I h}{2\pi b} \left(b - a \ln \frac{a+b}{a} \right) \text{ as required.} \end{aligned}$$

If $a = 30\text{ cm}$, $b = 10\text{ cm}$, $h = 5\text{ cm}$, $I = 10\text{ A}$,

$$\begin{aligned} \psi &= \frac{2\pi \times 10^{-7} \times 10 \times 0.05}{2\pi(5 \times 10^{-2})} \left(0.1 - 0.3 \ln \frac{4}{3} \right) \\ &= \underline{\underline{1.37 \times 10^{-8} \text{ Wb}}} \end{aligned}$$

Prob. 7.26

(a) $\bar{v} \cdot \bar{A} = -ya \sin ax \neq 0$

$$\begin{aligned} \bar{v} \times \bar{H} &= \begin{vmatrix} \frac{\partial}{\partial x} & \frac{\partial}{\partial y} & \frac{\partial}{\partial z} \\ y \cos ax & 0 & y + e^x \end{vmatrix} \\ &= \bar{a}_x + e^{-x} \bar{a}_y - \cos ax \bar{a}_z \neq 0 \end{aligned}$$

\bar{A} is neither electrostatic nor magnetostatic field

$$(b) \quad \bar{\mathbf{v}} \cdot \bar{\mathbf{B}} = \frac{1}{\rho} \frac{\partial}{\partial \rho} (\rho B_\rho) = \frac{1}{\rho} \frac{\partial}{\partial \rho} (20) = 0$$

$$\bar{\mathbf{v}} \times \bar{\mathbf{B}} = 0$$

$\bar{\mathbf{B}}$ can be $\bar{\mathbf{E}}$ - field in a charge - free region.

$$(c) \quad \bar{\mathbf{v}} \cdot \bar{\mathbf{C}} = \frac{1}{r^2} 4r^3 \sin \theta \neq 0$$

$$\bar{\mathbf{v}} \times \bar{\mathbf{C}} = \frac{1}{r \sin \theta} \frac{\partial}{\partial r} (r^2 \sin^2 \theta) \neq 0$$

$\bar{\mathbf{C}}$ is neither or $\bar{\mathbf{E}}$ nor $\bar{\mathbf{H}}$ field.

Prob. 7.27

$$(a) \quad \nabla \cdot \bar{\mathbf{D}} = 0$$

$$\nabla \times \bar{\mathbf{H}} = \begin{vmatrix} \frac{\partial}{\partial x} & \frac{\partial}{\partial y} & \frac{\partial}{\partial z} \\ u^2 z & 2(x+1)yz & -(x+1)z^2 \end{vmatrix}$$

$$= 2(x+1)y\bar{a}_x + \dots \neq 0$$

$\bar{\mathbf{D}}$ is a magnetostatic field.

$$(b) \quad \nabla \cdot \bar{\mathbf{E}} = 0$$

$$\nabla \times \bar{\mathbf{E}} = \frac{1}{\rho^2} \cos \theta \bar{a}_\rho + \dots \neq 0$$

$\bar{\mathbf{E}}$ can be a magnetostatic field.

$$(c) \quad \nabla \cdot \bar{\mathbf{F}} = 0$$

$$\nabla \times \bar{\mathbf{F}} = \frac{1}{r} \left[\frac{\partial}{\partial r} (r^{-1} \sin \theta) + \frac{2 \sin \theta}{r^2} \right] \bar{a}_\theta \neq 0$$

$\bar{\mathbf{F}}$ can be a magnetostatic field.

Prob. 7.28

$$(a) \quad \bar{\mathbf{B}} = \bar{\mathbf{V}} \times \bar{\mathbf{A}} = \begin{vmatrix} \frac{\partial}{\partial x} & \frac{\partial}{\partial y} & \frac{\partial}{\partial z} \\ 2x^2y + yz & xy^2 - xz^2 & -6xy + 2z^2y^2 \end{vmatrix}$$

$$\bar{\mathbf{B}} = \underline{\underline{(-6xz + 4z^2y + 2xz^2)\bar{a}_x + (y + 4yz)\bar{a}_y + (y^2 - z^2 - 2x^2 - z)\bar{a}_z, \text{ Wb/m}^2}}$$

$$(b) \quad \psi = \int \bar{\mathbf{B}} \cdot d\mathbf{S}, \quad d\mathbf{S} = dy \, dz \, dx$$

$$\begin{aligned} \psi &= \int_{z=0}^2 \int_{y=0}^2 (-6xz + 4zy - 2xy) dy \, dz \Big|_{x=1} \\ &= \int \int_0^2 (-6z) dy \, dz + 4 \int \int_0^2 z^2 y dy \, dz + 2 \int \int_0^2 y dy \, dz \\ &= -8 \int_0^2 z dz \int_0^2 dy + 4 \int_0^2 z^2 dz \int_0^2 y dy \\ &= -8 \frac{z^2}{2} \Big|_0^2 (2) + 4 \frac{z^3}{3} \Big|_0^2 \left(\frac{y^2}{2} \Big|_0^2 \right) = -32 + \frac{64}{3} \end{aligned}$$

$$\psi = -10.67 \text{ Wb}$$

$\bar{\mathbf{E}}$ can be a magnetostatic field.

$$(c) \quad \bar{\mathbf{V}} \cdot \bar{\mathbf{A}} = \frac{\partial A_x}{\partial x} + \frac{\partial A_y}{\partial y} + \frac{\partial A_z}{\partial z} = 4xy + 2xy - 6xy = 0$$

$$\bar{\mathbf{V}} \cdot \bar{\mathbf{B}} = -6z + 3z^3 + 1 + 6z - 3z^3 - 1 = 0$$

Prob. 7.29

$$\bar{\mathbf{B}} = \bar{\mathbf{V}} \times \bar{\mathbf{A}} = \frac{1}{\rho} \frac{\partial A_z}{\partial \phi} \bar{\mathbf{a}}_\rho - \frac{\partial A_z}{\partial \rho} \bar{\mathbf{a}}_\phi =$$

$$= \frac{15}{\rho} e^{-\rho} \cos \phi \bar{\mathbf{a}}_\rho + 15 e^{-\rho} \sin \phi \bar{\mathbf{a}}_\phi$$

$$\bar{\mathbf{B}} \left(3, \frac{\pi}{4}, -10 \right) = 5 e^{-3} \frac{1}{\sqrt{2}} \bar{\mathbf{a}}_\rho + 15 e^{-3} \frac{1}{\sqrt{2}} \bar{\mathbf{a}}_\phi$$

$$\bar{\mathbf{H}} = \frac{\bar{\mathbf{B}}}{\mu_0} = \frac{10^7}{4\pi} \frac{15}{\sqrt{2}} e^{-3} \left(\frac{1}{3} \bar{\mathbf{a}}_\rho + \bar{\mathbf{a}}_\phi \right)$$

$$\bar{\mathbf{H}} = (14 \bar{\mathbf{a}}_\rho + 42 \bar{\mathbf{a}}_\phi) \cdot 10^4 \text{ A/m}$$

$$\psi = \int \bar{\mathbf{B}} \cdot d\bar{\mathbf{s}} = \iint \frac{15}{\rho} e^{-\rho} \cos \phi \rho \, d\phi \, dz$$

$$= 15 z \Big|_0^{10} (-\sin \phi) \Big|_0^{\pi/2} e^{-5} = -150 e^{-5} \quad \Rightarrow \quad \psi = -1.011 \text{ Wb}$$

Prob. 7.30

Applying Ampere's law gives

$$H_\phi \cdot 2\pi\rho = \tau_o \cdot \pi\rho^2$$

$$H_\phi = \frac{\tau_o}{2} \rho$$

$$B_\phi = \mu_o H_\phi = \mu_o \frac{\tau_o \rho}{2}$$

But $B_\phi = \nabla \times \bar{A} = -\frac{\partial A_z}{\partial \rho} \bar{a}_\phi + \dots$

$$-\frac{\partial A_z}{\partial \rho} = \frac{1}{2} \mu \tau_o \rho$$

$$A_z = -\mu_o \frac{\tau_o \rho^2}{4}$$

$$\text{or } \underline{\underline{\bar{A} = \frac{1}{4} \mu_o \tau_o \rho^2 \bar{a}_z}}$$

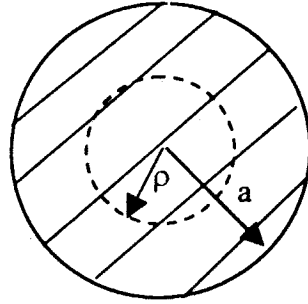
**Prob. 7.31**

$$\bar{A} = \frac{I_o \mu_o}{4\pi a^2} (x^2 + y^2) \bar{a}_z = -\frac{I_o \mu_o \rho^2}{4\pi a^2} \bar{a}_z$$

$$\bar{B} = \nabla \times \bar{A} = \frac{I_o \mu_o \rho}{4\pi a^2} \bar{a}_\phi = \mu_o \bar{H}$$

i.e. $\bar{H} = \frac{I_o \rho}{2\pi a^2} \bar{a}_\phi = \frac{I_o \sqrt{x^2 + y^2}}{2\pi a^2} \bar{a}_\phi$

By Ampere's law, $\oint \bar{H} \cdot d\bar{l} = I_{\text{enc}}$

$$H_\phi \cdot 2\pi\rho = I_o \cdot \frac{\rho^2}{a^2}$$

or $\underline{\underline{\bar{H} = \frac{I_o \rho}{2\pi a^2} \bar{a}_\phi}}$

Prob. 7.32

$$\bar{A} = \frac{\mu I}{2\pi} [\ln(d - \rho) - \ln \rho] \bar{a}_z$$

$$\begin{aligned} \bar{B} &= \bar{V} \cdot \bar{A} = \frac{-\partial A_z}{\partial \rho} \bar{a}_\rho = -\frac{\mu_o I}{2\pi} \left[-\frac{1}{d - \rho} - \frac{1}{\rho} \right] \bar{a}_\rho \\ &= \frac{\mu_o L d}{2\pi \rho (d - \rho)} \bar{a}_\rho \end{aligned}$$

Prob. 7.33

$$\bar{J} = \bar{V} \times \bar{H} = \bar{V} \times \frac{\bar{V} \times \bar{A}}{\mu_o} = \frac{1}{\mu_o} \bar{V} \times \bar{V} \times \bar{A}$$

$$\bar{V} \times \bar{A} = \frac{\hat{c}_z}{\partial \rho} \bar{a}_\rho = \frac{+20}{\rho^3} \bar{a}_\rho$$

$$\bar{V} \times \bar{V} \times \bar{A} = \frac{1}{\rho} \frac{\partial}{\partial d} (\rho A_z) \bar{a}_z = -\frac{40}{\rho^4} \bar{a}_z$$

$$\bar{J} = -\frac{40}{\mu_o \rho^4} \bar{a}_z \text{ A/m}^2$$

$$\text{or } \bar{V}^2 \bar{A} = -\mu_o \bar{J}$$

$$\text{or } \bar{J} = -\frac{1}{\mu_o} \bar{V}^2 \bar{A} = -\frac{1}{\mu_o} \bar{V}^2 A_z \bar{a}_z$$

$$= -\frac{1}{\mu_o} \bar{a}_z \left[\frac{1}{\rho} \frac{\partial}{\partial \rho} \left(\rho \frac{\partial A_z}{\partial \rho} \right) + \frac{1}{\rho^2} \frac{\partial^2 A_z}{\partial \phi^2} + \frac{\partial^2 A_z}{\partial z^2} \right]$$

$$= \frac{1}{\mu_o} \bar{a}_z \frac{1}{\rho} \frac{\partial}{\partial \rho} \left(\frac{20}{\rho^2} \right) = -\frac{40}{\mu_o \rho^4} \bar{a}_z \text{ A/m}^2$$

Prob. 7.34

$$\bar{H} = -\bar{\nabla}V_m \rightarrow V_m = -\int \bar{H} \cdot d\bar{l}$$

From Example 7.3, $\bar{H} = \frac{Ia^2}{2(z^2 + a^2)^{3/2}} \bar{a}_z$

$$V_m = -\frac{Ia^2}{2} \int 2(z^2 + a^2)^{3/2} dz = \frac{-Ia^2}{2(z^2 + a^2)^{1/2}} + c$$

As $z \rightarrow \infty$, $V_m = 0$, i.e.

$$0 = -\frac{I}{2} + c \rightarrow c = \frac{I}{2}$$

Hence,

$$V_m = \frac{I}{2} \left[1 - \frac{z}{\sqrt{z^2 + a^2}} \right]$$

Prob. 7.35

For the outer conductor,

$$J_z = -\frac{I}{\pi(c^2 - b^2)} = -\frac{I}{\pi(16 - 9)a^2} = -\frac{I}{7\pi a^2}$$

Let $\bar{A} = A_z \bar{a}_z$. Using Poisson's equation,

$$\bar{\nabla}^2 A_z = -\mu_0 J_z$$

$$\frac{1}{\rho} \frac{\partial}{\partial \rho} \left(\rho \frac{\partial A_z}{\partial \rho} \right) = \frac{\mu_0 I}{7a^2 \pi}$$

$$\text{or } \frac{\partial}{\partial \rho} \left(\rho \frac{\partial A_z}{\partial \rho} \right) = \frac{\mu_0 I \rho}{7\pi a^2}$$

Integrating once,

$$\rho \frac{\partial A_z}{\partial \rho} = \frac{\mu_0 I \rho^2}{14\pi a^2} + c_1$$

$$\text{or } \frac{\partial A_z}{\partial \rho} = \frac{\mu_0 I \rho}{14\pi a^2} + \frac{c_1}{\rho}$$

Integrating again,

$$A_z = \frac{\mu_o I \rho^2}{28\pi a^2} + c_1 \ln \rho + c_2$$

But $A_z = 0$ when $\rho = 3a$.

$$0 = \frac{9}{28\pi} \mu_o I + c_1 \ln 3a + c_2$$

$$c_2 = -c_1 \ln 3a - \frac{9}{28\pi} \mu_o I$$

i.e. $A_z = \frac{\mu_o I}{28\pi} \left(\frac{\rho^2}{a^2} - a \right) + c_1 \ln \frac{\rho}{3a}$

But $\nabla \times \bar{A} = \bar{B} = \mu_o \bar{H}$

$$\nabla \times \bar{A} = \frac{\partial A_z}{\partial \rho} \bar{a}_\phi = - \left(\frac{\mu_o I \rho}{14\pi a^2} + \frac{c_1}{\rho} \right) \bar{a}_\phi$$

At $\rho = 3a$, $\int \bar{H} \cdot d\bar{l} = I \rightarrow 2\pi(3a)H_\phi = I$

or $H_\phi = \frac{I}{6\pi a}$

Thus $\nabla \times \bar{A} \Big|_{\rho=3a} = \mu_o \bar{H} (\rho = 3a)$ implies that

$$- \left(\frac{3\mu_o I}{14\pi a} + \frac{c_1}{3a} \right) = \frac{\mu_o I}{6\pi a}$$

or $c_1 = -\frac{I\mu_o}{2\pi} - \frac{9\mu_o I}{14\pi} = -\frac{16\mu_o I}{14\pi}$

Thus,

$$\underline{\underline{A_z = \frac{\mu_o I}{28\pi} \left(\frac{\rho^2}{a^2} - a \right) - \frac{8\mu_o I}{7\pi} \ln \frac{\rho}{3a}}}$$

Prob. 7.36

$$\bar{H} = \frac{I}{2\pi\rho} \bar{a}_\phi$$

But $\bar{H} = -\nabla V_m \quad (\bar{T} = 0)$

$$\frac{I}{2\pi\rho} \bar{a}_\phi = -\frac{1}{\rho} \frac{\partial V_m}{\partial \phi} \bar{a}_\phi \rightarrow V_m = -\frac{I}{2\pi} \phi + C$$

$$\text{At } (10, 60^\circ, 7), \phi = 60^\circ = \frac{\pi}{3}, V_m = 0 \rightarrow 0 = -\frac{I}{2\pi} \cdot \frac{\pi}{3} + C$$

$$\text{or } C = \frac{I}{6}$$

$$V_m = -\frac{I}{2\pi} \phi + \frac{I}{6}$$

$$\text{At } (4, 30^\circ, -2), \phi = 30^\circ = \frac{\pi}{6},$$

$$V_m = -\frac{I}{2\pi} \cdot \frac{\pi}{6} + \frac{I}{6} = \frac{I}{12} = \frac{12}{12}$$

$$\underline{\underline{V_m = 1A}}$$

Prob. 7.37

For an infinite current sheet,

$$\bar{H} = \frac{1}{2} \bar{K} \times \bar{a}_n = \frac{1}{2} 50 \bar{a}_y \times \bar{a}_n = 25 \bar{a}_x$$

$$\text{But } \bar{H} = -\nabla V_m (\bar{J} = 0)$$

$$25 \bar{a}_x = -\frac{\partial V_m}{\partial x} \bar{a}_n \rightarrow V_m = -25x + c$$

At the origin, $x = 0, V_m = 0, c = 0$, i.e.

$$V_m = -25x$$

(a) At $(-2, 0, 5), V_m = 50A$.

(b) At $(10, 3, 1), V_m = -250A$.

Prob. 7.38

$$\begin{aligned}
 \text{(a)} \quad \nabla \times \nabla V &= \nabla \times \left(\frac{\partial V}{\partial \rho} \bar{a}_\rho + \frac{1}{\rho} \frac{\partial V}{\partial \phi} \bar{a}_\phi + \frac{\partial V}{\partial z} \bar{a}_z \right) \\
 &= \left(\frac{1}{\rho} \frac{\partial^2 V}{\partial \phi \partial z} - \frac{1}{\rho} \frac{\partial^2 V}{\partial z \partial \phi} \right) \bar{a}_\rho + \left(\frac{\partial^2 V}{\partial z \partial \rho} - \frac{\partial^2 V}{\partial \rho \partial z} \right) \bar{a}_\phi \\
 &\quad + \frac{1}{\rho} \left(\frac{\partial^2 V}{\partial \rho \partial \phi} - \frac{\partial^2 V}{\partial \phi \partial \rho} \right) \bar{a}_z = 0
 \end{aligned}$$

$$\begin{aligned}
 \text{(b)} \quad \nabla \cdot (\nabla \times \bar{A}) &= \nabla \cdot \left[\left(\frac{1}{\rho} \frac{\partial A_m}{\partial \phi} - \frac{\partial A_\rho}{\partial z} \right) \bar{a}_\rho \right. \\
 &\quad \left. + \left(\frac{\partial A_m}{\partial z} - \frac{\partial A_\rho}{\partial \rho} \right) \bar{a}_\phi + \frac{1}{\rho} \left(\frac{\partial}{\partial \rho} (\rho A_\phi) - \frac{\partial A_\rho}{\partial \phi} \right) \bar{a}_z \right] \\
 &= \frac{1}{\rho} \frac{\partial^2 A_m}{\partial \rho \partial \phi} - \frac{1}{\rho} \frac{\partial}{\partial \rho} \left(\rho \frac{\partial A_\phi}{\partial z} \right) + \frac{1}{\rho} \frac{\partial^2 A_\rho}{\partial \phi \partial z} - \frac{1}{\rho} \frac{\partial^2 A_z}{\partial \phi \partial \rho} + \frac{\partial}{\partial z} \left(\frac{1}{\rho} \frac{\partial}{\partial \rho} (\rho A_\phi) \right) \\
 &\quad - \frac{\partial}{\partial z} \left(\frac{1}{\rho} \frac{\partial A_\rho}{\partial \phi} \right) \\
 &= -\frac{\partial^2 A_\phi}{\partial \rho \partial z} - \frac{1}{\rho} \frac{\partial A_\phi}{\partial z} + \frac{\partial^2 A_\phi}{\partial z \partial \rho} + \frac{1}{\rho} \frac{\partial A_\phi}{\partial z} = 0
 \end{aligned}$$

Prob. 7.39

$$R = |\bar{r} - \bar{r}'| = \left[(x - x')^2 + (y - y')^2 + (z - z')^2 \right]^{1/2}$$

$$\begin{aligned}
 \nabla \frac{1}{R} &= \left(\frac{\partial}{\partial x} \bar{a}_x + \frac{\partial}{\partial y} \bar{a}_y + \frac{\partial}{\partial z} \bar{a}_z \right) \left[(x - x')^2 + (y - y')^2 + (z - z')^2 \right]^{1/2} \\
 &= -\frac{1}{2} 2(x - x') \bar{a}_x \left[(x - x')^2 + (y - y')^2 + (z - z')^2 \right]^{-3/2} \\
 &= -\left[(x - x') \bar{a}_x + (y - y') \bar{a}_y + (z - z') \bar{a}_z \right] / R^3 = -\frac{\bar{R}}{R^3}
 \end{aligned}$$

$$\begin{aligned}
 \nabla' \frac{1}{R} &= \left(\frac{\partial}{\partial x'} \bar{a}_x + \frac{\partial}{\partial y'} \bar{a}_y + \frac{\partial}{\partial z'} \bar{a}_z \right) \left[(x - x')^2 + (y - y')^2 + (z - z')^2 \right]^{1/2} \\
 &= \left(-\frac{1}{2} \right) (-2)(x - x') \bar{a}_x \left[(x - x')^2 + (y - y')^2 + (z - z')^2 \right]^{-3/2} = \frac{\bar{R}}{R^3}
 \end{aligned}$$

CHAPTER 8

P.E. 8.1

$$(a) F = m \frac{\partial \bar{u}}{\partial t} = QE = \underline{\underline{6a_z N}}$$

$$(b) \frac{\partial \bar{u}}{\partial t} = 6a_z = \frac{\partial}{\partial t}(u_x, u_y, u_z) \Rightarrow$$

$$\frac{\partial u_x}{\partial t} = 0 \rightarrow u_x = A$$

$$\frac{\partial u_y}{\partial t} = 0 \rightarrow u_y = B$$

$$\frac{\partial u_z}{\partial t} = 6 \rightarrow u_z = 6t + C$$

$$\text{Since } \bar{u}(t=0) = 0, \quad A = B = C = 0$$

$$u_x = 0 = u_y, \quad u_z = 6t$$

$$u_x \frac{\partial x}{\partial t} = 0 \rightarrow x = A$$

$$u_y \frac{\partial y}{\partial t} = 0 \rightarrow y = B$$

$$u_z \frac{\partial z}{\partial t} = 6t \rightarrow z = 3t^2 + C_1$$

$$\text{At } t=0, (x,y,z) = (0,0,0) \rightarrow A_1 = 0 = B_1 = C_1$$

$$\text{Hence, } (x,y,z) = (0,0,3t^2),$$

$$u = 6ta_z \text{ at any time. At } P(0,0,12), z = 12 = 3t^2 \rightarrow t = 2s$$

$$\underline{\underline{t = 2s}}$$

$$(c) u = 6t\bar{a}_z = 12a_z \text{ m/s.}$$

$$a = \frac{\partial \bar{U}}{\partial t} = \underline{\underline{6a_z \text{ m/s}^2}}$$

$$(d) K.E = \frac{1}{2} m |\bar{U}|^2 = \frac{1}{2} (1)(144) = \underline{\underline{72J}}$$

P.E. 8.2

$$(a) \quad m\bar{a} = e\bar{u} \times B = (eB_0 u_y, -eB_0 u_x, 0)$$

$$\frac{d^2 x}{dt^2} = \frac{eB_0}{m} \frac{dy}{dt} = w \frac{dy}{dt} \quad (1)$$

$$\frac{d^2 y}{dt^2} = -\frac{eB_0}{m} \frac{dx}{dt} = -w \frac{dx}{dt} \quad (2)$$

$$\frac{d^2 z}{dt^2} = 0; \Rightarrow \frac{dz}{dt} = C_1 \quad (3)$$

From (1) and (2),

$$\frac{d^3 x}{dt^3} = w \frac{d^2 y}{dt^2} = -w^2 \frac{dx}{dt}$$

$$(D^2 + w^2 D)x = 0 \rightarrow Dx = (0, \pm jw)x$$

$$x = c_2 + c_3 \cos wt + c_4 \sin wt$$

$$\frac{dy}{dt} = \frac{1}{w} \frac{d^2 x}{dt^2} = -c_3 w \cos wt - c_4 w \sin wt$$

At $t = 0$, $\vec{u} = (\alpha, 0, \beta)$. Hence,

$$c_1 = \beta, c_3 = 0, c_4 = \frac{\alpha}{w}$$

$$\underline{\underline{\frac{dx}{dt} = \alpha \cos wt, \frac{dy}{dt} = -\alpha \sin wt, \frac{dz}{dt} = \beta}}}$$

(b) Solving these yields

$$x = \frac{\alpha}{w} \sin wt, y = \frac{\alpha}{w} \cos wt, z = \beta t$$

$$(c) \quad x^2 + y^2 = \frac{\alpha^2}{w^2}, z = \beta t$$

showing that the particles move along a helix of radius $\frac{\alpha}{w}$ placed along the z-axis.

P.E. 8.3

(a) From Example 8.3, $QuB = QE$ regardless of the sign of the charge.

$$E = uB = 8 \times 10^6 \times 0.5 \times 10^{-3} = \underline{\underline{4 \text{ kV/m}}}$$

(b) Yes, since $QuB = QE$ holds for any Q and m .

P.E. 8.4

By Newton's 3rd law, $\vec{F}_{12} = \vec{F}_{21}$, the force on the infinitely long wire is:

$$\vec{F}_1 = -\vec{F} = \frac{\mu_0 I_1 I_2 b}{2\pi} \left(\frac{1}{\rho_0} - \frac{1}{\rho_0 + a} \right) \vec{a}_\rho$$

$$= \frac{4\pi \times 10^{-7} \times 50 \times 3}{2\pi} \left(\frac{1}{2} - \frac{1}{3} \right) \underline{\underline{\vec{a}_\rho}} = \underline{\underline{5\vec{a}_\rho \mu N}}$$

P.E. 8.5

$$\vec{m} = IS\vec{a}_n = 10 \times 10^{-4} \times 50 \frac{(2, 6, -3)}{7}$$

$$= 7.143 \times 10^{-3} (2, 6, -3)$$

$$= \underline{\underline{(1.429\vec{a}_x + 4.286\vec{a}_y - 2.143\vec{a}_z)} \times 10^{-2} \text{ A-m}^2}$$

P.E. 8.6

$$(a) \quad \vec{T} = \vec{m} \times \vec{B} = \frac{10 \times 10^{-4} \times 50}{7 \times 10} \begin{vmatrix} 2 & 6 & -3 \\ 6 & 4 & 5 \end{vmatrix}$$

$$= \underline{\underline{0.03\vec{a}_x - 0.02\vec{a}_y - 0.02\vec{a}_z \text{ N-m}}}$$

$$(b) \quad |\vec{T}| = ISB \sin \theta \rightarrow |\vec{T}|_{\max} = ISB$$

$$|\vec{T}|_{\max} = \frac{50 \times 10^{-2}}{10} |6\vec{a}_x + 4\vec{a}_y + 5\vec{a}_z| = 0.4387$$

$$\text{or } |\vec{T}|_{\max} = |\vec{m} \times \vec{B}| = |-0.3055\vec{a}_x + 0.076\vec{a}_y + 0.3055\vec{a}_z| = \underline{\underline{0.4387 \text{ Nm}}}$$

P.E. 8.7

$$(a) \quad \mu_r = \frac{\mu}{\mu_o} = 4.6, \chi_m = \mu_r - 1 = \underline{\underline{3.6}}$$

$$(b) \quad \vec{H} = \frac{\vec{B}}{\mu} = \frac{10 \times 10^{-3} e^{-y}}{4\pi \times 10^{-7} \times 4.6} \vec{a}_z \text{ A/m} = \underline{\underline{1730e^{-y} \vec{a}_z \text{ A/m}}}$$

$$(c) \quad M = \chi_m \vec{H} = \underline{\underline{6228e^{-y} \text{ A/m}}}$$

P.E. 8.8

$$\vec{a}_n = \frac{3\vec{a}_x + 4\vec{a}_y}{5}$$

$$\vec{B}_{1n} = (\vec{B}_1 \cdot \vec{a}_n) \vec{a}_n = \frac{(6 + 32)(6\vec{a}_x + 8\vec{a}_y)}{1000}$$

$$= 0.228\vec{a}_x + 0.304\vec{a}_y = B_{2n}$$

$$\vec{B}_{1t} = (\vec{B}_1 \cdot \vec{B}_{1n}) = -0.128\vec{a}_x + 0.096\vec{a}_y + 0.2\vec{a}_z$$

$$\vec{B}_{2t} = \frac{\mu_2}{\mu_1} \vec{B}_{1t} = 10\vec{B}_{1t} = -1.28\vec{a}_x + 0.96\vec{a}_y + 2\vec{a}_z$$

$$\vec{B}_2 = \vec{B}_{2n} + \vec{B}_{2t} = \underline{\underline{-1.052\vec{a}_x + 1.264\vec{a}_y + 2\vec{a}_z}} \text{ Wb/m}^2$$

P.E. 8.9

$$(a) \quad \vec{B}_{1n} = \vec{B}_{2n} \rightarrow \mu_1 \vec{H}_{1n} = \mu_2 \vec{H}_{2n}$$

$$\text{or } \mu_1 \vec{H}_1 \cdot \vec{a}_{n21} = \mu_2 \vec{H}_2 \cdot \vec{a}_{n21}$$

$$\mu_o \frac{(60 + 2 - 36)}{7} = 2\mu_o \frac{(6H_{2x} + 10 - 12)}{7}$$

$$35 = 6H_{2x}$$

$$\underline{\underline{H_{2x} = 5.833}}$$

$$(b) \quad \vec{K} = (\vec{H}_1 - \vec{H}_2) \times \vec{a}_{n12} = \vec{a}_{n21} \times (\vec{H}_1 - \vec{H}_2)$$

$$= \vec{a}_{n21} \times [(1, 1, 12) - (35/6, -5, 4)]$$

$$= \frac{1}{7} \begin{vmatrix} 6 & 2 & -3 \\ 25/6 & 6 & 8 \end{vmatrix}$$

$$\underline{\underline{\vec{K} = 4.86\vec{a}_x - 8.64\vec{a}_y + 3.95\vec{a}_z}} \text{ A/m}$$

- (c) Since $\vec{B} = \mu\vec{H}$, \vec{B}_1 and \vec{H}_1 are parallel, i.e. they make the same angle with the normal to the interface.

$$\cos\theta_1 = \frac{\vec{H}_1 \cdot \vec{a}_{n21}}{|\vec{H}_1|} = \frac{26}{7\sqrt{100+1+144}} = 0.2373$$

$$\underline{\underline{\theta_1 = 76.27^\circ}}$$

$$\cos\theta_2 = \frac{\vec{H}_2 \cdot \vec{a}_{n21}}{|\vec{H}_2|} = \frac{13}{7\sqrt{(5.833)^2 + 25 + 16}} = 0.2144$$

$$\underline{\underline{\theta_2 = 77.62^\circ}}$$

P.E. 8.10

$$(a) \quad L' = \mu_o \mu_r n^2 S = 4\pi \times 10^{-7} \times 1000 \times 16 \times 10^6 \times 4 \times 10^{-4}$$

$$= \underline{\underline{8.042 \text{ H/m}}}$$

$$(b) \quad W_m' = \frac{1}{2} L' I^2 = \frac{1}{2} (8.042)(0.5^2) = \underline{\underline{1.005 \text{ J/m}}}$$

P.E. 8.11 From Example 8.11,

$$L_{\text{in}} = \frac{8I}{8\pi}$$

$$L_{\text{ext}} = \frac{2w_m}{I^2} = \frac{1}{I^2} \iiint \frac{\mu I^2}{4\pi^2 \rho^2} \rho d\rho ddz$$

$$= \frac{1}{4\pi^2} \int_0^l dz \int_0^{2\pi} d\phi \int_a^b \frac{2\mu_o}{(1+\rho)\rho} d\rho$$

$$= \frac{\mu_o l}{\pi} \cdot 2\pi \int_a^b \left[\frac{1}{\rho} - \frac{1}{(1+\rho)} \right] d\rho$$

$$= \frac{\mu_o l}{\pi} \left[\ln \frac{b}{a} - \ln \frac{1+b}{1+a} \right]$$

$$L = L_{\text{in}} + L_{\text{ext}} = \frac{\mu_o l}{8\pi} + \frac{\mu_o l}{\pi} \left[\ln \frac{b}{a} - \ln \frac{1+b}{1+a} \right]$$

P.E. 8.12

$$(a) \quad L'_{\text{in}} = \frac{\mu_o}{8\pi} = \frac{4\pi \times 10^{-7}}{8\pi} = \underline{0.05 \mu\text{H/m}}$$

$$L'_{\text{ext}} = L' - L'_{\text{in}} = 1.2 - 0.05 = \underline{1.15 \mu\text{H/m}}$$

$$(b) \quad L' = \frac{\mu_o}{2\pi} \left[\frac{1}{4} + \ln \frac{d-a}{a} \right]$$

$$\ln \frac{d-a}{a} = \frac{2\pi l'}{\mu_o} - 0.25 = \frac{2\pi \times 1.2 \times 10^{-6}}{4\pi \times 10^{-7}} - 0.25$$

$$= 6 - 0.25 = 5.75$$

$$\frac{d-a}{a} = e^{5.75} = 314.19$$

$$d-a = 314.19a = 314.19 \times \frac{2.588 \times 10^{-3}}{2} = 406.6 \text{ mm}$$

$$d = 407.9 \text{ mm} = \underline{40.79 \text{ cm}}$$

P.E. 8.13

This is similar to Example 8.13. In this case, however, $h=0$ so that

$$\vec{A}_1 = \frac{\mu_o I_1 a^2 b}{4b^3} \vec{a}_\phi$$

$$\phi_{12} = \frac{\mu_o I_1 a^2}{4b^2} \cdot 2\pi b = \frac{\mu_o \pi I_1 a^2}{2b}$$

$$m_{12} = \frac{\phi_{12}}{I_1} = \frac{\mu_o \pi a^2}{b} = \frac{4\pi \times 10^{-7} \times \pi \times 4}{2 \times 3}$$

$$= \underline{2.632 \mu\text{H}}$$

P.E. 8.14

$$L_{in} = \frac{\mu_o}{8\pi} l = \frac{\mu_o 2\pi \rho_o}{8\pi} = \frac{4\pi \times 10^{-7} \times 10 \times 10^{-7}}{4}$$

$$= \underline{31.42 \text{ nH}}$$

P.E. 8.15

(a) From Example 7.6,

$$B_{ave} = \frac{\mu_o NI}{L} = \frac{\mu_o NI}{2\pi \rho_o}$$

$$\phi = B_{ave} \cdot S = \frac{\mu_o NI}{2\pi \rho_o} \cdot \pi a^2$$

$$\text{or } I = \frac{2\rho_o \phi}{\mu a^2 N} = \frac{2 \times 10 \times 10^{-2} \times 0.5 \times 10^{-3}}{4\pi \times 10^{-7} \times 10^{-4} \times 10^3}$$

$$= \underline{795.77\text{A}}$$

Alternatively, using circuit approach

$$R = \frac{l}{\mu S} = \frac{2\pi \rho_o}{\mu_o S} = \frac{2\pi \rho_o}{\mu_o \pi a^2}$$

$$\Im = NI = \frac{\phi \mathfrak{R}}{N} = \frac{2\rho_o \phi}{\mu a^2 N}, \text{ as obtained before.}$$

$$\mathfrak{R} = \frac{2\rho_o}{\mu a^2} = \frac{2 \times 10 \times 10^{-2}}{4\pi \times 10^{-7} \times 10^{-4}} = 1.591 \times 10^9$$

$$\Im = \phi \mathfrak{R} = 0.5 \times 10^{-3} \times 1.591 \times 10^9 = 7.955 \times 10^5$$

$$I = \frac{\Im}{N} = 795\text{A} \text{ as obtained before.}$$

(b) If $\mu = 500\mu_o$,

$$I = \frac{795.77}{500} = \underline{1.592\text{A}}$$

P.E. 8.16

$$\Im = \frac{B^2 a S}{2\mu_o} = \frac{(1.5)^2 \times 10 \times 10^{-4}}{2 \times 4\pi \times 10^{-7}} = \frac{22500}{8\pi} = \underline{895.25\text{N}}$$

Prob. 8.1

$$\begin{aligned}\bar{F} &= q(\bar{E} + \mathbf{u} \times \bar{B}) \\ \text{If } \bar{F} &= 0, \quad \bar{E} = -\mathbf{u} \times \bar{B} = \bar{B} \times \mathbf{u} \\ &= \begin{vmatrix} 10 & 20 & 30 \\ 3 & 12 & -4 \end{vmatrix} \times 10^5 \times 10^{-3} \\ \bar{E} &= -4.4\bar{a}_x + 1.3\bar{a}_y + 11.4\bar{a}_z \text{ kV/m}\end{aligned}$$

Prob. 8.2

$$\bar{F} = m\mathbf{a} = q\mathbf{u} \times \bar{B}$$

$$\bar{a} = \frac{q}{m} \mathbf{u} \times \bar{B}$$

$$\frac{d}{dt}(u_x, u_y, u_z) = 0 \rightarrow \frac{2}{1} \begin{vmatrix} u_x & u_y & u_z \\ 1 & 0 & 0 \end{vmatrix} = 2(0, u_z, -u_y)$$

$$\frac{du_x}{dt} = 0 \rightarrow u_x = C_0 \quad \dots \quad (1)$$

$$\frac{du_y}{dt} = 2u_z, \quad \frac{du_z}{dt} = -2u_y$$

$$\frac{d^2 u_y}{dt^2} = 2, \quad \frac{du_z}{dt} = -4u_y$$

$$\ddot{u}_y + 4u_y = 0$$

$$u_y = C_1 \cos 2t + C_2 \sin 2t \quad \dots \quad (2)$$

$$u_z = \frac{1}{2} \frac{du_y}{dt} = -C_1 \sin 2t + C_2 \cos 2t \quad \dots \quad (3)$$

$$\text{At } t=0, \quad u_x = 0 \rightarrow c_0 = 0$$

$$u_y = 0 \rightarrow c_1 = 0$$

$$u_z = 10 \rightarrow c_2 = 10$$

Hence,

$$\bar{\mathbf{u}} = (0, 10 \sin 2t, 10 \cos 2t)$$

$$u_x = \frac{dx}{dt} = 0 \rightarrow x = c_4$$

$$u_y = \frac{dy}{dt} = 10 \sin 2t \rightarrow y = -5 \cos 2t + c_5$$

$$u_z = 10 \cos 2t \rightarrow z = 5 \sin 2t + c_6$$

At $t = 0$,

$$x = 0 \rightarrow c_4 = 0$$

$$y = 0 \rightarrow c_5 = 5$$

$$z = 0 \rightarrow c_6 = 0$$

Hence,

$$(x, y, z) = (0, 5 - 5 \cos 2t, 5 \sin 2t)$$

At $t = 0$,

$$(x, y, z) = (0, 5 - 5 \cos 4, 5 \sin 4)$$

$$= (0, 8.268, -3.724)$$

$$\bar{u} = (0, 10 \sin 4, 10 \cos 4) = (0, -7.568, -6.536)$$

$$\text{K.E} = \frac{1}{2} m |\bar{u}|^2 = \frac{1}{2} (100 \sin^2 4 + 100 \cos^2 4)$$

$$= \underline{\underline{50 \text{ J}}}$$

Prob. 8.3

(a) $F = m\bar{a} = Q(\bar{E} + \bar{u} \times \bar{B})$

$$\frac{d}{dt}(u_x, u_y, u_z) = 2 \left[-4\bar{a}_y + \begin{vmatrix} u_x & u_y & u_z \\ 5 & 0 & 0 \end{vmatrix} \right] = -8\bar{a}_y + 10u_z\bar{a}_y - 10u_y\bar{a}_z$$

i.e. $\frac{du_x}{dt} = 0 \rightarrow u_x = A_1$ (1)

$$\frac{du_y}{dt} = -8 + 10u_z$$
 (2)

$$\frac{du_z}{dt} = -10u_y$$
 (3)

$$\frac{d^2 u_y}{dt^2} = 0 + 10 \frac{du_z}{dt} = -100u_y$$

$$\ddot{u}_y + 100u_y = 0 \rightarrow u_y = B_1 \cos 10t + B_2 \sin 10t$$

From (2),

$$10u_z = 8 + \dot{u}_y = 8 - 10B_1 \sin 10t + 10B_2 \cos 10t$$

$$u_z = 0.8 - B_1 \sin 10t + B_2 \cos 10t$$

At $t=0$, $\bar{u} = 0 \rightarrow A_1 = 0, B_1 = 0, B_2 = -0.8$

Hence,

$$\bar{u} = (0, 0.8\sin 10t, 0.8 - 0.8\cos 10t) \quad (4)$$

$$u_x = \frac{dx}{dt} = 0 \rightarrow x = c_1$$

$$u_y = \frac{dy}{dt} = -0.8\sin 10t \rightarrow y = 0.08\cos 10t + c_2$$

$$u_z = \frac{dz}{dt} = 0.8 - 0.8\cos 10t \rightarrow z = 0.8t + c_3 - 0.08\sin 10t$$

$$\text{At } t=0, (x, y, z) = (2, 3, -4) \Rightarrow c_1=2, c_2=2.92, c_3=-4$$

$$\text{Hence } (x, y, z) = (2, 2 + 0.08\cos 10t, 0.8t - 0.08\sin 10t - 4)$$

At $t=1$,

$$(x, y, z) = (2, 1.933, -3.156)$$

(b) From (4), at $t=1$, $\bar{u} = (0, 0.435, 1.471)$ m/s

$$\text{K.E.} = \frac{1}{2} m |\bar{u}|^2 = \frac{1}{2} (1)(0.435^2 + 1.471^2) = \underline{\underline{1.177\text{J}}}$$

Prob. 8.4

$$m\bar{a} = Q\bar{u} \times \bar{B}$$

$$10^{-3}\bar{a} = -2 \times 10^{-3} \begin{vmatrix} u_x & u_y & u_z \\ 0 & 6 & 0 \end{vmatrix}$$

$$\frac{d}{dt}(u_x, u_y, u_z) = (12u_z, 0, -12u_x)$$

$$\text{i.e. } \frac{du_x}{dt} = -12u_z \quad (1)$$

$$\frac{du_y}{dt} = 0 \rightarrow u_y = A_1 \quad (2)$$

$$\frac{du_z}{dt} = -12u_x \quad (3)$$

From (1) and (2),

$$\ddot{u}_x = -12\dot{u}_z = -144u_x$$

or

$$\ddot{u}_x + 144u_x = 0 \rightarrow u_x = c_1 \cos 12t + c_2 \sin 12t$$

From (1), $u_z = -c_1 \sin 12t + c_2 \cos 12t$

At $t=0$,

$$u_x=2, u_y=0, u_z=0 \rightarrow A_1=0=c_2, c_1=5$$

Hence,

$$\vec{u} = (5 \cos 12t, 0, -5 \sin 12t)$$

$$\vec{u}(t=10s) = (5 \cos 120, 0, -5 \sin 120) = \underline{4.071\vec{a}_x - 2.903\vec{a}_z} \text{ m/s}$$

$$u_x = \frac{dx}{dt} = 5 \cos 12t \rightarrow x = \frac{5}{12} \sin 12t + B_1$$

$$u_y = \frac{dy}{dt} = 0 \rightarrow y = B_2$$

$$u_z = \frac{dz}{dt} = -5 \sin 12t \rightarrow z = \frac{5}{12} \cos 12t + B_3$$

$$\text{At } t=0, (x, y, z) = (0, 1, 2) \rightarrow B_1=0, B_2=1, B_3=\frac{19}{12}$$

$$(x, y, z) = \left(\frac{5}{12} \sin 12t, 1, \frac{5}{12} \cos 12t + \frac{19}{12} \right) \quad (4)$$

At $t=10s$,

$$(x, y, z) = \left(\frac{5}{12} \sin 120, 1, \frac{5}{12} \cos 120 + \frac{19}{12} \right) = \underline{(0.2419, 1, 1.923)}$$

By eliminating t from (4),

$$x^2 + (z - \frac{19}{12})^2 = (\frac{5}{12})^2, y=1 \text{ which is a helix with axis on line } y=1, z=\frac{19}{12}$$

Prob. 8.5

$$(a) \quad m\vec{a} = e(\vec{u} \times \vec{B})$$

$$\frac{m}{e} \frac{d}{dt} (u_x, u_y, u_z) = \begin{vmatrix} u_x & u_y & u_z \\ 0 & 0 & B_z \end{vmatrix} = u_y B_z \vec{a}_x - B_z u_x \vec{a}_y$$

$$\frac{du_z}{dt} = 0 \rightarrow u_z = c = 0$$

$$\frac{du_x}{dt} = u_y \frac{B_0 e}{m} = u_y w, \text{ where } w = \frac{B_0 e}{m}$$

$$\frac{du_y}{dt} = -u_x w$$

Hence,

$$\ddot{u}_x = w \dot{u}_y = -w^2 u_x$$

$$\text{or } \ddot{u}_x + w^2 u_x = 0 \rightarrow u_x = A \cos wt + B \sin wt$$

$$u_y = \frac{\dot{u}_x}{w} = -A \sin wt + B \cos wt$$

At $t=0$, $u_x = u_0$, $u_y = 0 \rightarrow A = u_0$, $B=0$

Hence,

$$u_x = u_0 \cos wt = \frac{dx}{dt} \rightarrow x = -\frac{u_0}{w} \sin wt + c_1$$

$$u_y = -u_0 \sin wt = \frac{dy}{dt} \rightarrow y = -\frac{-u_0}{w} \cos wt + c_2$$

At $t=0$, $x = 0 = y \rightarrow c_1=0$, $c_2=\frac{u_0}{w}$. Hence,

$$x = -\frac{u_0}{w} \sin wt, y = \frac{u_0}{w} (1 - \cos wt)$$

$$\frac{u_0^2}{w^2} (\cos^2 wt + \sin^2 wt) = \left(\frac{u_0}{w}\right)^2 = x^2 + \left(y - \frac{u_0}{w}\right)^2$$

showing that the electron would move in a circle centered at $(0, \frac{u_0}{w})$. But since the field does not exist throughout the circular region, the electron passes through a semi-circle and leaves the field horizontally.

(b) $d =$ twice the radius of the semi-circle

$$= \frac{2u_0}{w} = \frac{2u_0 m}{B_0 e}$$

Prob.8.6

$$\vec{F} = \int I d\vec{l} \times \vec{R}$$

$$= I \int_{x=1}^3 dx \vec{a}_x \times \vec{B} + I \int_{y=1}^3 dy \vec{a}_y \times \vec{B} + I \int_{x=3}^1 dx \vec{a}_x \times \vec{B} + I$$

$$+ I \int_{y=2}^1 dy \vec{a}_y \times \vec{B}$$

$$\vec{a}_x \times \vec{B} = \begin{vmatrix} 1 & 0 & 0 \\ 6x & -9x & 3z \end{vmatrix} = -3z\vec{a}_y - 9y\vec{a}_z$$

$$\vec{a}_y \times \vec{B} = \begin{vmatrix} 0 & 1 & 0 \\ 6x & -9x & 3z \end{vmatrix} = 3z\vec{a}_x - 6x\vec{a}_z$$

$$\vec{F} = I \int_1^3 dx (-3z\vec{a}_y - 9y\vec{a}_z) \Big|_{z=0}^{z=1} + I \int_1^2 dy (3z\vec{a}_x - 6x\vec{a}_z) \Big|_{z=0}^{z=3}$$

$$+ I \int_3^1 dx (-3z\vec{a}_y - 9y\vec{a}_z) \Big|_{z=0}^{z=1} + I \int_2^1 dy (3z\vec{a}_x - 6x\vec{a}_z) \Big|_{z=1}^{z=3}$$

$$= I(-18-18+36+6)\vec{a}_z = 6I\vec{a}_z$$

$$= 6 \times 5\vec{a}_z = \underline{\underline{30\vec{a}_z \text{ N}}}$$

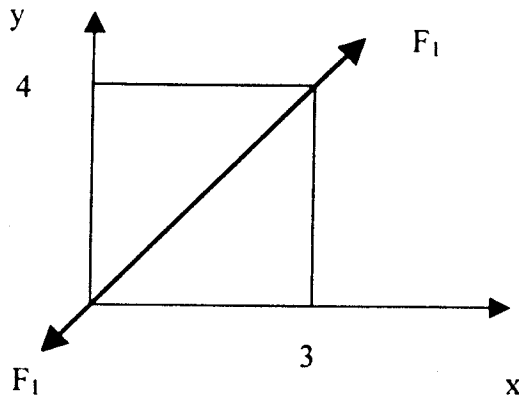

Prob. 8.7

$$\vec{B}_1 = \frac{\mu I_1}{2\pi\rho} \vec{a}_\phi, \quad \rho = 3$$

$$\vec{a}_y = \vec{a}_z \times \left(\frac{-3\vec{a}_y - 4\vec{a}_x}{5} \right) = -\frac{3\vec{a}_y + 4\vec{a}_x}{5}$$

$$\vec{B}_1 = \frac{4\pi \times 10^{-7} \times 15}{r-1} \left(\frac{4}{5}\vec{a}_x - \frac{3}{5}\vec{a}_y \right) = \frac{6 \times 10^{-7}}{5} (4\vec{a}_x - 3\vec{a}_y)$$

$$\begin{aligned} \vec{F}_2 = d\vec{F} = Id\vec{l} \times \vec{B} &= 2 \times 10^{-2} \times 12 \times 10^{-3} \vec{a}_x \times \frac{6 \times 10^{-7}}{5} (4\vec{a}_x - 3\vec{a}_y) \\ &= \underline{\underline{-86.4 \vec{a}_x \text{ pN}}} \end{aligned}$$

Prob. 8.8

$$\vec{\mathcal{S}} = L\vec{L} \times \vec{B} \rightarrow \vec{\mathcal{S}} = \frac{\vec{F}}{L} = I_1 \vec{a}_1 \times \vec{B}_2 = \frac{\mu_0 I_1 I_2 a_1 \times \vec{a}_\phi}{2\pi\rho}$$

$$(a) \quad \vec{F}_{21} = \frac{\vec{a}_z \times (-\vec{a}_x) 4 \times 10^{-7} (-2 \times 10^4)}{2\pi \cdot 4}$$

$$= \underline{\underline{\vec{a}_y}} \text{ mN/m (repulsive)}$$

$$(b) \quad \vec{F}_{12} = -\vec{F}_{21} = \underline{\underline{-\vec{a}_y}} \text{ mN/m (repulsive)}$$

$$(c) \quad \vec{a}_1 \times \vec{a}_\phi = \vec{a}_z \times \left(-\frac{4}{5}\vec{a}_x + \frac{3}{5}\vec{a}_y \right) = -\frac{3}{5}\vec{a}_x - \frac{4}{5}\vec{a}_y, \quad \rho = 5$$

$$\vec{F}_{31} = \frac{4\pi \times 10^{-7} (-3 \times 10^4)}{2\pi(5)} \left(-\frac{3}{5}\vec{a}_x - \frac{4}{5}\vec{a}_y \right)$$

$$= \underline{\underline{0.72\vec{a}_x + 0.96\vec{a}_y}} \text{ mN/m (attractive)}$$

$$(d) \quad \vec{F}_3 = \vec{F}_{31} + \vec{F}_{32}$$

$$\vec{F}_{32} = \frac{4\pi \times 10^{-7} \times 6 \times 10^4}{2\pi(3)} (\vec{a}_z \times \vec{a}_1) = \underline{\underline{-4\vec{a}_x}} \text{ mN/m (attractive)}$$

$$\underline{\underline{\vec{F}_3}} = -3.28\vec{a}_x + 0.96\vec{a}_y \text{ mN/m}$$

(attractive due to L_2 and repulsive due to L_1)

Prob. 8.9

$$W = -\int \vec{F} \cdot d\vec{l}, \vec{F} = \int L d\vec{l} \times \vec{B} = 3(2\vec{a}_z) \times \cos d/3 \vec{a}_\phi$$

$$= 6 \cos d/3 \vec{a}_\phi \text{ mN}$$

$$W = -\int_0^{2\pi} 6 \cos d/3 \rho_o dd = -6 \times 3 \sin d/3 \Big|_0^{2\pi} \text{ mJ}$$

$$= -18 \sin \frac{2\pi}{3} = \underline{\underline{-15.59 \text{ mJ}}}$$

Prob. 8.10

$$(a) \quad \vec{F}_1 = \int_{\rho=2}^4 \frac{\mu_o I_1 I_2}{2\pi\rho} d\rho \vec{a}_\rho \times \vec{a}_\phi = \frac{4\pi \times 10^{-7}}{2\pi} (2)(5) \ln 4/2 \vec{a}_z$$

$$= 2 \ln 2 \vec{a}_z \text{ } \mu\text{N} = \underline{\underline{1.3863 \vec{a}_z \text{ } \mu\text{N}}}$$

$$(b) \quad \vec{F}_2 = \int I_2 d\vec{l}_2 \times \vec{B}_1$$

$$= \frac{\mu_o I_1 I_2}{2\pi} \int \frac{1}{\rho} [d\rho \vec{a}_\rho + dz \vec{a}_z] \times \vec{a}_\phi$$

$$= \frac{\mu_o I_1 I_2}{2\pi} \int \frac{1}{\rho} [d\rho \vec{a}_z - dz \vec{a}_\rho]$$

But $\rho = z+2, dz = d\rho$

$$\vec{F}_2 = \frac{4\pi \times 10^{-7}}{2\pi} (5)(2) \int_{\rho=4}^2 \frac{1}{\rho} [d\rho \vec{a}_z - dz \vec{a}_\rho]$$

$$2 \ln 2/4 (\vec{a}_z - \vec{a}_\rho) \mu\text{N} = 1.386 \vec{a}_\rho - 1.386 \vec{a}_z \mu\text{N}$$

$$\vec{F}_3 = \frac{\mu_o I_1 I_2}{2\pi} \int \frac{1}{\rho} [d\rho \vec{a}_z - dz \vec{a}_\rho]$$

But $z = -\rho + 6, dz = -d\rho$

$$\vec{F}_3 = \frac{4\pi \times 10^{-7}}{2\pi} (5)(2) \int_{\rho=6}^4 \frac{1}{\rho} [d\rho \vec{a}_z - dz \vec{a}_\rho]$$

$$2 \ln 4/6 (\vec{a}_z + \vec{a}_\rho) \mu\text{N} = -0.8109 \vec{a}_\rho - 0.8109 \vec{a}_z \mu\text{N}$$

$$\vec{F} = \vec{F}_1 + \vec{F}_2 + \vec{F}_3$$

$$= 1.3863 \vec{a}_z + 1.386 \vec{a}_\rho - 1.3863 \vec{a}_z - 0.8109 \vec{a}_\rho - 0.8109 \vec{a}_z$$

$$= 0.5751 \vec{a}_\rho - 0.8109 \vec{a}_z \text{ } \mu\text{N}$$

Prob. 8.11

From Prob. 8.7,

$$\vec{f} = \frac{\mu_o I_1 I_2}{2\pi\rho} \vec{a}_\rho$$

$$\vec{f} = \vec{f}_{AC} + \vec{f}_{BC}$$

$$\vec{f}_{AC} = \vec{f}_{BC} = \frac{4\pi \times 10^{-7} \times 75 \times 150}{2\pi \times 2} = 1.125 \times 10^{-3}$$

$$\vec{f} = 2 \times 1.125 \cos 30^\circ \vec{a}_x \text{ mN/m}$$

$$= \underline{\underline{1.949 \vec{a}_x \text{ mN/m}}}$$

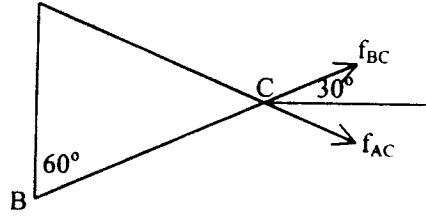
**Prob. 8.12**

$$\vec{F} = \int L d\vec{l} \times \vec{B} = \int \vec{J} dv \times \vec{B}$$

$$\vec{J} = \frac{I}{\pi(b^2 - a^2)} \vec{a}_z, \vec{B} = B_o \vec{a}_\rho$$

$$\vec{F} = \frac{I}{\pi(b^2 - a^2)} \int \vec{a}_z dv \times B_o \vec{a}_\rho = \frac{IB_o \vec{a}_\rho}{\pi(b^2 - a^2)} \int dv$$

$$= \frac{IB_o}{\pi(b^2 - a^2)} \pi(a^2 - b^2) l$$

$$\vec{f} = \frac{\vec{F}}{l} = \underline{\underline{IB_o \vec{a}_\phi}}$$

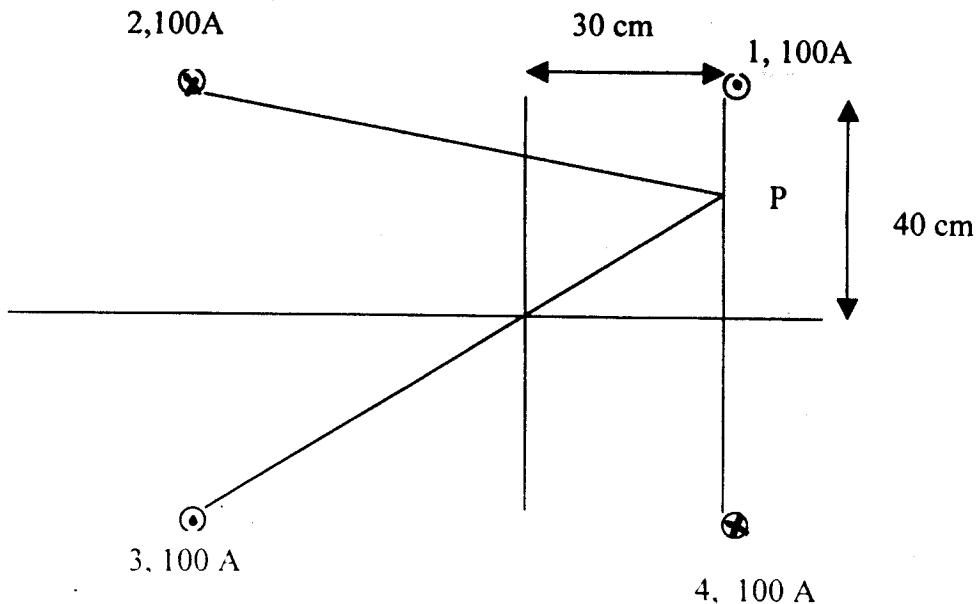
Prob. 8.13

$$\text{Let } \vec{B} = \vec{B}_1 + \vec{B}_2 + \vec{B}_3 + \vec{B}_4$$

$$\text{where } \vec{B}_n = \frac{\mu_0 \mu_r I}{2\pi\rho} \vec{a}_\phi$$

$$\text{For (1), } \vec{a}_\phi = \vec{a}_1 \times \vec{a}_\rho \vec{a}_z \times (-\vec{a}_y) = \vec{a}_x,$$

$$\vec{B}_1 = \frac{4\pi \times 10^{-7} \times 2000 \times 100}{2\pi \times 20 \times 10^{-3}} \vec{a}_x = 2\vec{a}_x$$

$$\text{For (2), } \vec{\rho} = 6\vec{a}_x - 2\vec{a}_y,$$

$$\vec{a}_\phi = -\vec{a}_z \times \frac{(6\vec{a}_x - 2\vec{a}_y)}{\sqrt{40}} = \frac{(-2\vec{a}_x - 6\vec{a}_y)}{\sqrt{40}}$$

$$\vec{B}_2 = \frac{4\pi \times 10^{-7} \times 2000 \times 100}{2\pi \times 400 \times 10^{-3}} (-2\vec{a}_x - 6\vec{a}_y)$$

$$= -0.2\vec{a}_x - 0.6\vec{a}_y$$

$$\text{For (3), } \vec{\rho} = 6\vec{a}_x + 6\vec{a}_y,$$

$$\vec{a}_\phi = \vec{a}_z \times \frac{(6\vec{a}_x + 6\vec{a}_y)}{\sqrt{72}} = \frac{(-6\vec{a}_x + 6\vec{a}_y)}{\sqrt{72}}$$

$$\begin{aligned} \vec{B}_3 &= \frac{4\pi \times 10^{-7} \times 2000 \times 100}{2\pi \times 720 \times 10^{-3}} (-6\vec{a}_x + 6\vec{a}_y) \\ &= -0.3333\vec{a}_x + 0.3333\vec{a}_y \end{aligned}$$

$$\text{For (4), } \vec{a}_\phi = -\vec{a}_z \times \vec{a}_y = \vec{a}_x,$$

$$\vec{B}_4 = \frac{4\pi \times 10^{-7} \times 2000 \times 100}{2\pi \times 60 \times 10^{-3}} \vec{a}_x = 0.6667\vec{a}_x$$

$$\begin{aligned} \vec{B} &= (2 + \frac{2}{3} - \frac{1}{5} - \frac{1}{3})\vec{a}_x + (-\frac{3}{5} + \frac{1}{3})\vec{a}_y \\ &= \underline{\underline{2.1333\vec{a}_x - 0.2667\vec{a}_y}} \text{ Wb/m}^2 \end{aligned}$$

Prob. 8.14

$$T = mB = NISB = 1000 \times 2 \times 10^{-3} \times 300 \times 10^{-6} \times 0.4$$

$$= \underline{\underline{240\mu\text{Nm}}}$$

Prob. 8.15

$$\vec{B} = \frac{k}{r^3} (2\cos\theta\vec{a}_r + \sin\theta\vec{a}_\theta)$$

$$\text{At } (10, 0, 0), r = 10; \theta = \frac{\pi}{2}, \vec{a}_r = \vec{a}_x, \vec{a}_\theta = -\vec{a}_z$$

$$-0.5 \times 10^{-3} \bar{a}_z = \frac{k}{10^3} (0 - \bar{a}_x) \rightarrow k = 0.5$$

Thus,

$$\bar{B} = \frac{0.5}{r^3} (2 \cos \theta \bar{a}_r + \sin \theta \bar{a}_\theta)$$

(a) At (0, 3, 0), $r=3$, $\theta = \pi/2$, $\bar{a}_r = \bar{a}_y$, $\bar{a}_\theta = -\bar{a}_z$

$$\bar{B} = \frac{0.5}{27} (0 - \bar{a}_z) = \underline{\underline{-18.52 \bar{a}_z \text{ mWb/m}^2}}$$

(b) At (3, 4, 0), $r=5$, $\theta = \pi/2$, $\bar{a}_\theta = -\bar{a}_z$

$$\bar{B} = \frac{0.5}{125} (0 - \bar{a}_z) = \underline{\underline{-4 \bar{a}_z \text{ mWb/m}^2}}$$

(c) At (1, -1, 1), $r=\sqrt{3}$, $\tan \theta = \rho/z = \sqrt{2}/-1$, i.e.

$$\sin \theta = \sqrt{2}/3, \cos \theta = -1/3$$

$$\bar{B} = \frac{0.5}{3\sqrt{3}} \left(-\frac{1}{3} \bar{a}_r + \frac{\sqrt{2}}{3} \bar{a}_\theta \right) = \underline{\underline{-111 \bar{a}_r + 78.6 \bar{a}_\theta \text{ mWb/m}^2}}$$

Prob. 8.16 (a) $\bar{M} = \chi_m H = \chi_m \frac{B}{\mu_0 \mu}$

$$= \frac{4999}{5000} \times \frac{1.5}{4\pi \times 10^{-7}} = \underline{\underline{1.194 \times 10^6 \text{ A/m}}}$$

(b) $\bar{M} = \frac{\sum_{k=1}^N m_k}{\Delta v}$

If we assume that all \bar{m}_k align with the applied \bar{B} field,

$$M = \frac{Nm_k}{\Delta v} \rightarrow m_k = \frac{Nm_k}{N/\Delta v} = \frac{1.194 \times 10^6}{8.5 \times 10^{28}}$$

$$m_k = \underline{\underline{1.047 \times 10^{-23} \text{ A} \cdot \text{m}^2}}$$

Prob. 8.17

(a) $\psi_m = \mu_r - 1 = \underline{\underline{5.5}}$

(b) $\bar{B} = \mu_0 \mu_r \bar{H} = 4\pi \times 10^{-7} \times 6.5(10, 25, -40)$

$$= \underline{\underline{81.68 \bar{a}_x + 204.2 \bar{a}_y - 326.7 \bar{a}_z \text{ } \mu\text{Wb/m}^2}}$$

(c) $\bar{M} = \psi_m \bar{H} = \underline{\underline{55 \bar{a}_x + 137.5 \bar{a}_y - 220 \bar{a}_z \text{ A/m}}}$

(d) $W_m = \frac{1}{2} \mu \bar{H} \cdot \bar{H} = \frac{1}{2} (6.5) 4\pi \times 10^{-7} \times 6.5(100 + 625 + 1600)$

$$= \underline{\underline{9.5 \text{ mJ/m}^2}}$$

Prob. 8.18

(a) $\psi_m = \mu_r - 1 = \underline{3.5}$

(b) $\bar{H} = \frac{\bar{B}}{\mu} = \frac{4y \bar{a}_z \times 10^{-3}}{4\pi \times 10^{-7} \times 4.5} = \underline{707.3y \bar{a}_z \text{ A/m}}$

(c) $\bar{M} = \psi_m \bar{H} = \underline{2.476y \bar{a}_z \text{ kA/m}}$

(d)
$$\bar{r}_b = \bar{V} \times \bar{M} = \begin{vmatrix} \frac{\partial}{\partial x} & \frac{\partial}{\partial y} & \frac{\partial}{\partial z} \\ 0 & 0 & M_z(y) \end{vmatrix} = \frac{dM_z}{dy} \bar{a}_x$$

$$= \underline{2.476 \bar{a}_x \text{ kA/m}^2}$$

Prob. 8.19

For case 1,

$$\mu = \frac{B_1}{H_1} = \frac{2}{1200}$$

$$\mu_r = \frac{\mu}{\mu_0} = \frac{1}{600} \times \frac{1}{4\pi \times 10^{-7}} = 1326.3$$

$$\psi_m = \mu_r - 1 = 1325.3$$

$$\bar{M}_1 = \psi_m H_1 = 1,590,366$$

For case 2,

$$\mu = \frac{B_2}{H_2} = \frac{1.4}{400}$$

$$\mu_r = \frac{\mu}{\mu_0} = \frac{1.4}{400} \times \frac{1}{4\pi \times 10^{-7}} = 2785.2$$

$$\psi_m = \mu_r - 1 = 2784.2$$

$$M = \psi_m H = 1,113,630$$

$$\Delta M = M_1 - M_2 = 476,680$$

$$= \underline{476.7 \text{ kA/m}}$$

Prob. 8.20

$$\oint \bar{H} \cdot d\bar{l} = I_{\text{enc}}$$

$$H_{\phi} \cdot 2\pi\rho = \frac{\pi\rho^2}{\pi a^2} \cdot I \rightarrow H_{\phi} = \frac{I\rho}{2\pi a^2}$$

$$\bar{M} = \psi_m \bar{H} = \frac{(\mu_r - 1) I \rho}{2\pi a^2} \bar{a}_{\phi}$$

$$J_b = \nabla \times \bar{M} = \frac{1}{\rho} \frac{\partial}{\partial \rho} (\rho M_{\phi}) = \frac{(\mu_r - 1) I}{\pi a^2} \bar{a}_z$$

Prob. 8.21

$$J_b = \nabla \times \bar{M} = \frac{k_0}{a} \begin{vmatrix} \frac{\partial}{\partial x} & \frac{\partial}{\partial y} & \frac{\partial}{\partial z} \\ -y & x & 0 \end{vmatrix} = \frac{2k_0}{a} \bar{a}_z$$

Prob. 8.22

(a) From $H_{1t} - H_{2t} = k$ and $M = \chi_m H$, we obtain:

$$\frac{M_{1t}}{\chi_{m1}} - \frac{M_{2t}}{\chi_{m2}} = k$$

Also from $B_{1n} - B_{2n} = k$ and $B = \mu H = (\mu/\chi_m)M$, we get:

$$\frac{\mu_1 M_{1n}}{\chi_{m1}} = \frac{\mu_2 M_{2n}}{\chi_{m2}}$$

(b) From $B_1 \cos \theta_1 - B_{1n} = B_{2n} = B_2 \cos \theta_2$ (1)

and $\frac{B_1 \sin \theta_1}{\mu_1} = H_{2t} = k + H_{2t} = k + \frac{B_2 \sin \theta_2}{\mu_2}$ (2)

Dividing (2) by (1) gives

$$\frac{\tan \theta_1}{\mu_1} = \frac{k}{B_2 \cos \theta_2} + \frac{\tan \theta_2}{\mu_2} = \frac{\tan \theta_2}{\mu_2} \left(1 + \frac{k\mu_2}{B_2 \sin \theta_2} \right)$$

$$\text{i.e. } \frac{\tan \theta_1}{\tan \theta_2} = \frac{\mu_1}{\mu_2} \left(1 + \frac{k\mu_2}{B_2 \sin \theta_2} \right)$$

Prob. 8.23

$$(a) \quad \bar{B}_{1n} = \bar{B}_{2n} = 1.5 \bar{a}_\phi$$

$$\bar{H}_{1t} = \bar{H}_{2t} \rightarrow \frac{\bar{B}_{1t}}{\mu_1} = \frac{\bar{B}_{2t}}{\mu_2}$$

$$\bar{B}_{1t} = \frac{\mu_1}{\mu_2} \bar{B}_{2t} = \frac{5\mu_1}{2\mu_2} (10 \bar{a}_\rho - 20 \bar{a}_z) = 25 \bar{a}_\rho - 50 \bar{a}_z$$

Hence,

$$\bar{B}_{1t} = \underline{\underline{25 \bar{a}_\rho + 15 \bar{a}_\phi - 50 \bar{a}_z \text{ mWb/m}^2}}$$

$$(b) \quad W_{m1} = \frac{1}{2} \bar{B}_1 \cdot \bar{H}_1 = \frac{B_1^2}{2\mu_1} = \frac{(25^2 + 15^2 + 50^2) \times 10^{-6}}{2 \times 2 \times 4\pi \times 10^{-7}}$$

$$W_1 = \underline{\underline{666.5 \text{ J/m}^3}}$$

$$W_2 = \frac{B_2^2}{2\mu_2} = \frac{(10^2 + 15^2 + 20^2) \times 10^{-6}}{2 \times 5 \times 4\pi \times 10^{-7}} = \underline{\underline{57.7 \text{ J/m}^3}}$$

Prob. 8.24

$$(a) \quad W_{m1} = \frac{1}{2} \bar{B}_1 \cdot \bar{H}_1 = \frac{1}{2} \mu_0 \mu_{r1} \bar{H}_1 \cdot \bar{H}_1, \quad \mu_r = 1$$

$$W_{m1} = \frac{1}{2} \times 4\pi \times 10^{-7} \times 1 (16 + 9 + 1)$$

$$= \underline{\underline{16.34 \mu\text{J/m}^3}}$$

(b)

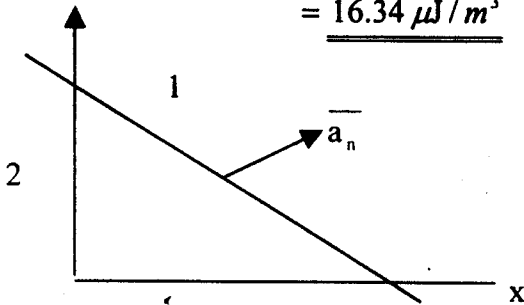

$$f(x, y) = 2x + y - 8 = 0$$

$$\nabla f = 2\bar{a}_x + \bar{a}_y, \quad \bar{a}_n = \frac{\nabla f}{|\nabla f|} = \frac{2\bar{a}_x + \bar{a}_y}{\sqrt{5}}$$

$$\bar{H}_{1n} = (\bar{H}_1 \cdot \bar{a}_n) \bar{a}_n = \left(\frac{-8+3}{5} \right) (2\bar{a}_x + \bar{a}_y) = -2\bar{a}_x - \bar{a}_y$$

$$\bar{H}_{1t} = \bar{H}_1 - \bar{H}_{1n} = -2\bar{a}_x + 4\bar{a}_y - \bar{a}_z = \bar{H}_{2t}$$

$$\bar{B}_{2n} = \bar{B}_{1n} \rightarrow \mu_2 \bar{H}_{2n} = \mu_1 \bar{H}_{1n}$$

$$\begin{aligned} \bar{H}_{2n} &= \frac{\mu_1}{\mu_2} \bar{H}_{1n} = \frac{1}{10} (-2\bar{a}_x - \bar{a}_y) \\ &= -0.2\bar{a}_x - 0.1\bar{a}_y \end{aligned}$$

$$\bar{H}_2 = \bar{H}_{2t} + \bar{H}_{2n} = -2.2\bar{a}_x + 3.9\bar{a}_y - \bar{a}_z$$

$$\bar{M}_2 = \psi_{m2} \bar{H}_2 = 9H_2 = -19.8\bar{a}_x + 35.1\bar{a}_y - 9\bar{a}_z \text{ A/m}$$

$$\bar{B}_2 = \mu_2 \bar{H}_2 = 10\mu_0 \bar{H}_2$$

$$= 4\pi(-2.2, 2.9, -1) \mu \text{Wb/m}^2$$

$$\bar{B}_2 = -27.65\bar{a}_x + 49\bar{a}_y - 12.56\bar{a}_z \mu \text{Wb/m}^2$$

$$H_2 = H_{2t} + H_{2n} = -2.2a_x + 3.9a_y - a_z$$

$$H_2 = H_{2t} + H_{2n} = -2.2a_x + 3.9a_y - a_z$$

$$M_2 = \chi_{m2} H_2 = 9H_2 = \underline{\underline{-19.8a_x + 35.1a_y - 9a_z \text{ A/m}}}$$

$$B_2 = \mu_2 H_2 = 10\mu_0 H_2 = 4\pi x(-2.2, 2.9, -1) \mu \text{Wb/m}^2$$

$$= \underline{\underline{-27.75a_x + 49a_y - 12.56a_z \mu \text{Wb/m}^2}}$$

(c) $H_1 \cdot a_n = H_1 \cos\theta_1$

$$\cos\theta_1 = \frac{H_1 \cdot a_n}{H_1} = \frac{(-8+3)/\sqrt{9}}{\sqrt{16+9+1}} = -0.4389 \quad \longrightarrow \quad \underline{\underline{\theta_1 = 116^\circ}}$$

$$\cos\theta_2 = \frac{H_2 \cdot a_n}{H_2} = \frac{(-4.4 + 3.9)/\sqrt{5}}{\sqrt{4.588}} = -0.1044 \quad \longrightarrow \quad \underline{\underline{\theta_2 = 96^\circ}}$$

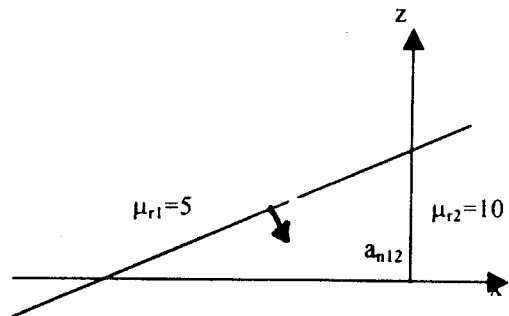
Prob. 8.25

Let $\vec{H}_2 = (H_x, H_y, H_z)$

$$(\vec{H}_1 - \vec{H}_2) \times \vec{a}_{n12} = \vec{k}$$

where $f(x, z) = 5z - 4x = 0$ and

$$\vec{a}_{n12} = -\frac{\nabla f}{|\nabla f|} = \frac{4\vec{a}_x - 5\vec{a}_z}{\sqrt{41}}$$

$$(\vec{H}_1 - \vec{H}_2) \times \vec{a}_{n12} = \frac{1}{\sqrt{41}} \begin{vmatrix} 25 - H_x & -30 - H_y & 45 - H_z \\ 4 & 0 & -5 \end{vmatrix}$$

$$= \frac{1}{\sqrt{41}} [150 + 5H_y, 180 - 4H_z, 120 + 4H_y] = \vec{k} = 35\vec{a}_y$$

Equating components,

$$\vec{a}_x: \quad 150 + 5H_y = 0 \rightarrow H_y = -30$$

$$\vec{a}_y: \quad 300 - 4H_z - 5H_x = 35 \rightarrow 4H_z + 5H_x = 270$$

$$\vec{a}_z: \quad 120 + 4H_y = 0 \rightarrow H_y = -30$$

Also, $\vec{B}_{1n} = \vec{B}_{2n} \rightarrow \mu_1 \vec{H}_{1n} = \mu_2 \vec{H}_{2n}$

$$5\mu_0(2, -30, 45) \frac{(4, 0, 5)}{\sqrt{41}} = 10\mu_0(H_x, H_y, H_z) \frac{(4, 0, 5)}{\sqrt{41}}$$

$$100 - 225 = 68H_x - 10H_z$$

$$\begin{aligned} \text{or } 125 &= 10H_z - 8H_x \\ &= 10H_z - 8(54 - 0.8H_z) \quad \longrightarrow \quad H_z = 33.96 \end{aligned}$$

$$\text{and } H_x = 54 - 0.8 H_z = 26.83$$

Thus,

$$\underline{\underline{\vec{H}_z = 26.83\vec{a}_x - 30\vec{a}_y + 33.96\vec{a}_z \text{ A/m}}}$$

Prob. 8.26

$$\vec{H}_{1n} = -3\vec{a}_z, \vec{H}_{1t} = 10\vec{a}_x + 15\vec{a}_y$$

$$\vec{H}_{2t} = \vec{H}_{1t} = 10\vec{a}_x + 15\vec{a}_y$$

$$\vec{H}_{2n} = \frac{\mu_1}{\mu_2} \vec{H}_{1n} = \frac{1}{200} (-3\vec{a}_z) = -0.015\vec{a}_z$$

$$\vec{H}_2 = 10\vec{a}_x + 15\vec{a}_y - 0.015\vec{a}_z$$

$$\vec{B}_2 = \mu_2 \vec{H}_2 = 200 \times 4\pi \times 10^{-7} (10, 15, -0.015)$$

$$\underline{\underline{\vec{B}_2 = 2.51\vec{a}_x + 3.77\vec{a}_y - 0.0037\vec{a}_z \text{ mWb/m}^2}}$$

$$\tan \alpha = \frac{B_{2n}}{B_{2t}}$$

$$\text{or } \alpha = \tan^{-1} \frac{0.0037}{\sqrt{2.51^2 + 3.77^2}} = \underline{\underline{0.047^\circ}}$$

Prob. 8.27

$$(a) \quad \vec{H} = \frac{1}{2} \vec{k} \times \vec{a}_n = \frac{1}{2} (30 - 40)\vec{a}_x \times (-\vec{a}_y) = \underline{\underline{-5\vec{a}_y \text{ A/m}}}$$

$$\vec{B} = \mu_o \vec{H} = 4\pi \times 10^{-7} (-5\vec{a}_y) = \underline{\underline{-6.28\vec{a}_y \mu \text{Wb/m}^2}}$$

$$(b) \quad \vec{H} = \frac{1}{2} (-30 - 40)\vec{a}_y = \underline{\underline{-35\vec{a}_y \text{ A/m}}}$$

$$\vec{B} = \mu_o \mu_r \vec{H} = 4\pi \times 10^{-7} (-35\vec{a}_y) = \underline{\underline{-110\vec{a}_y \mu \text{Wb/m}^2}}$$

$$(c) \quad \vec{H} = \frac{1}{2}(-30 + 40)\vec{a}_y = \underline{\underline{5\vec{a}_y}}$$

$$\vec{B} = \mu_o \vec{H} = \underline{\underline{6.283\vec{a}_y \mu \text{ Wb/m}^2}}$$

$$\text{Prob. 8.28} \quad \mu_r = \psi_m + 1 = 20$$

$$W_m = \frac{1}{2} \vec{B}_1 \cdot \vec{H}_1 = \frac{1}{2} \mu \vec{H} \cdot \vec{H}$$

$$= \frac{1}{2} \mu (25x^4 y^2 z^2 + 100x^2 y^4 z^2 + 225x^2 y^2 z^4)$$

$$W_m = \int W_m dv$$

$$= \frac{1}{2} \mu \left[25 \int_0^1 x^4 dx \int_0^2 y^2 dy \int_{-1}^2 z^2 dz + 100 \int_0^1 x^2 dx \int_0^2 y^4 dy \int_{-1}^2 z^2 dz \right. \\ \left. + 225 \int_0^1 x^2 dx \int_0^2 y^2 dy \int_{-1}^2 z^4 dz \right]$$

$$= \frac{25\mu}{2} \left[\frac{x^5}{5} \Big|_0^1 \frac{y^3}{3} \Big|_0^2 \frac{z^3}{3} \Big|_{-1}^2 + 4 \frac{x^3}{3} \Big|_0^1 \frac{y^5}{5} \Big|_0^2 \frac{z^3}{3} \Big|_{-1}^2 \right.$$

$$\left. + 9 \frac{x^3}{3} \Big|_0^1 \frac{y^3}{3} \Big|_0^2 \frac{z^5}{5} \Big|_{-1}^2 \right]$$

$$= \frac{25\mu}{2} \left(\frac{1}{5} \cdot \frac{8}{3} \cdot \frac{9}{3} + \frac{4}{3} \cdot \frac{32}{3} \cdot \frac{9}{3} + \frac{9}{3} \cdot \frac{8}{3} \cdot \frac{33}{5} \right)$$

$$= \frac{25}{2} \times 4\pi \times 10^{-7} \times 20 \times \frac{3600}{45}$$

$$W_m = \underline{\underline{25.13 \text{ mJ}}}$$

Prob. 8.29

$$(a) \quad B = 70 + (210)^2 = 44.17 \text{ Wb/m}^2$$

$$\mu_r = \frac{B}{\mu_o H} = \frac{44.17 \times 10^3}{4\pi \times 10^{-7} \times 210} = \underline{\underline{167.4}}$$

$$\begin{aligned}
 (b) \quad W_m &= \int_0^{H_o} H dB = \int_0^{H_o} H \left(\frac{1}{3} + 2H \right) dH \\
 &= \frac{H_o^2}{6} + \frac{2}{3} H_o^3 = 7350 + 6174000 \\
 &= \underline{6181.35} \text{ kJ/m}^3
 \end{aligned}$$

Prob. 8.30

$$(a) \quad L = \frac{\lambda}{l} = \frac{N\psi}{l} = \frac{\mu_o N^2 I_a}{2\pi} \ln \left(\frac{2\rho_o + a}{2\rho_o - a} \right)$$

$$(b) \quad L = \frac{N\psi}{l} = \mu_o N^2 [\rho_o - (\rho_o^2 - a^2)^{1/2}]$$

when $\rho_o \gg a$, binomial series expansion gives:

$$L = \frac{\mu_o N^2 a^2}{2\rho_o}$$

Or from Example 8.10,

$$L = L'l = \frac{\mu_o N^2 l S}{l^2} = \frac{\mu_o N^2 \pi a^2}{2\pi\rho_o} = \frac{\mu_o N^2 a^2}{2\rho_o}$$

Prob. 8.31

For $d \gg a$,

$$L' = \frac{L}{l} = \frac{\mu_o}{\pi} \ln \frac{d}{a} = \frac{4\pi \times 10^{-7}}{\pi} \ln \frac{d}{a} = 2.5 \times 10^{-6}$$

$$\text{or } \ln \frac{d}{a} = 6.25 \rightarrow \frac{d}{a} = e^{6.25} = 518.01$$

$$a = \frac{3}{518.01} = 5.78 \text{ mm}$$

$$D = 2a = 11.58 \text{ mm}$$

Prob. 8.32

$$L = \frac{\mu_o N^2 S}{l} = \frac{4\pi \times 10^{-7} \times (450)^2 \times \pi (10^{-2})^2}{0.1} = \underline{80 \mu\text{H}}$$

Prob. 8.33

$$L = \frac{\mu N^2 S}{l} \rightarrow N^2 = \frac{Ll}{\mu S} = \frac{L2\pi\rho_o}{\mu_o\mu_r S}$$

$$= \frac{2.5 \times 2\pi \times 0.5}{4\pi \times 10^{-7} \times 200 \times 12 \times 10^{-4}} = \frac{25}{96} \times 10^8$$

$$N = \underline{5103 \text{ turns}}$$

Prob. 8.34

$$\psi_{12} = \int \vec{B}_1 \cdot d\vec{S} = \int_{z=0}^b \frac{\mu_o I}{2\pi\rho} dz d\rho = \frac{\mu_o I b}{2\pi} \ln \frac{a + \rho_o}{\rho_o}$$

For $N = 1$,

$$M_{12} = \frac{N\psi_{12}}{I_1} = \frac{\mu_o b}{2\pi} \ln \frac{a + \rho_o}{\rho_o}$$

$$= \frac{4\pi \times 10^{-7}}{2\pi} (1) \ln 2 = \underline{\underline{0.1386 \mu \text{ H}}}$$

Prob. 8.35

We may approximate the longer solenoid as infinite so that $B_1 = \frac{\mu_o N_1 I_1}{l_1}$. The flux linking the second solenoid is:

$$\psi_2 = N_2 B_1 S_1 = \frac{\mu_o N_1 I_1}{l_1} \cdot \pi r_1^2$$

$$M = \frac{\psi_2}{I_1} = \frac{\mu_o N_1 N_2}{l_1} \cdot \pi r_1^2$$

Prob. 8.36

$$NI = Hl = \frac{Bl}{\eta}$$

$$N = \frac{Bl}{\lambda_o \eta_r I} = \frac{1.5 \times 0.6\pi}{4\pi \times 10^{-7} \times 600 \times 12}$$

$$= \underline{\underline{312.5}}$$

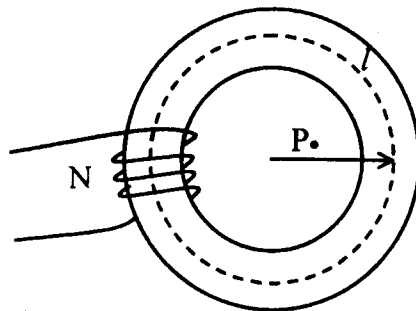
**Prob. 8.37**

$$F = NI = 400 \times 0.5 = 200 \text{ A.t}$$

$$F_a = \frac{R_a}{R_a + R_3 + R_1 // R_2} = \frac{796 \times 10^3 \times 200}{(796 + 383) \times 10^3} = \underline{\underline{190.8 \text{ A.t}}}$$

$$H_a = \frac{F_a}{l_a} = \frac{190.8}{1 \times 10^{-2}} = \underline{\underline{19080 \text{ A/m}}}$$

Prob. 8.38

$$\text{Total } F = NI = 2000 \times 10 = 20,000 \text{ A.t}$$

$$R_c = \frac{l_c}{\mu_o \mu_r S} = \frac{(24 + 20 - 0.6) \times 10^{-2}}{4\pi \times 10^{-7} \times 1500 \times 2 \times 10^{-4}} = \underline{0.115 \times 10^7 \text{ A.t/m}}$$

$$R_a = \frac{l_a}{\mu_o \mu_r S} = \frac{0.6 \times 10^{-2}}{4\pi \times 10^{-7} (1) \times 2 \times 10^{-4}} = \underline{2.387 \times 10^7 \text{ A.t/m}}$$

$$R = R_a + R_c = 2.502 \times 10^7 \text{ A.t/m}$$

$$\psi = \frac{\mathfrak{F}}{R} = \psi_a = \psi_c = \frac{20,000}{2.502 \times 10^7} = \underline{8 \times 10^{-4} \text{ Wb/m}^2}$$

$$\mathfrak{F}_a = \frac{R_a}{R_a + R_c} \mathfrak{F} = \frac{2.387 \times 20,000}{2.502} = \underline{19,081 \text{ A.t}}$$

$$\mathfrak{F}_c = \frac{R_c}{R_a + R_c} \mathfrak{F} = \frac{0.115 \times 20,000}{2.502} = \underline{919 \text{ A.t}}$$

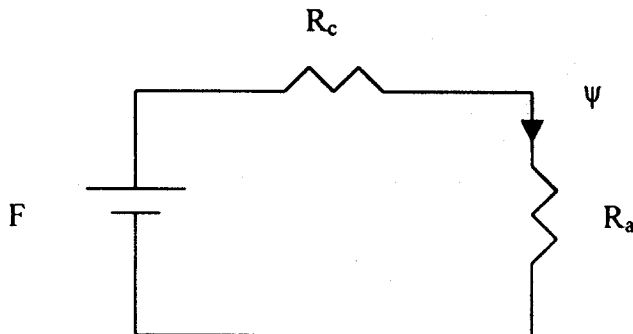
Prob. 8.39

$$F = NI = 500 \times 0.2 = 100 \text{ A.t}$$

$$R_c = \frac{l_c}{\mu S} = \frac{42 \times 10^{-2}}{4\pi \times 10^{-7} \times 10^3 \times 4 \times 10^{-4}} = \frac{42 \times 10^6}{16\pi}$$

$$R_a = \frac{l_a}{\mu_o S} = \frac{10^{-3}}{4\pi \times 10^{-7} \times 4 \times 10^{-4}} = \frac{10^8}{16\pi}$$

$$R_a + R_c = \frac{1.42 \times 10^8}{16\pi}$$

$$\psi = \frac{F}{R_a + R_c} = \frac{16\pi \times 100}{1.42 \times 10^8} = \frac{16\pi}{1.42} \mu \text{ Wb}$$

$$B_a = \frac{\psi}{S} = \frac{16\pi \times 10^{-6}}{1.42 \times 4 \times 10^{-4}} = \underline{\underline{88.5 \text{ mWb/m}^2}}$$

Prob. 8.40

$$F = \frac{B_a^2 S}{2\mu_0} = \frac{\psi^2}{2\mu_0 S} = \frac{4 \times 10^{-6}}{2 \times 4\pi \times 10^{-7} \times 0.3 \times 10^{-4}} = \underline{\underline{53.05 \text{ kN}}}$$

Prob. 8.41

(a) $F = NI = 200 \times 10^{-3} \times 750 = 150 \text{ A.t.}$

$$R_a = \frac{l_a}{\mu_0 S} = \frac{10^{-3}}{25 \times 10^{-6} \mu_0} = 3.183 \times 10^7$$

$$R_l = \frac{l_l}{\mu_r \mu_0 S} = \frac{2\pi \times 0.1}{\mu_0 \times 300 \times 25 \times 10^{-6}} = 20 \times 10^7$$

$$\psi = \frac{\mathfrak{I}}{R_a + R_l} = \frac{150}{10^7 (3.183 + 20)} = 20 \times 10^7$$

$$F = \frac{B^2 S}{2\mu_0} = \frac{\psi^2}{2\mu_0 S} = \frac{41.861 \times 10^{-14}}{2 \times 4\pi \times 10^{-7} \times 25 \times 10^{-6}}$$

$$= \underline{\underline{6.66 \text{ mN}}}$$

(c) If $\mu_l \rightarrow \infty$, $R_l = 0$, $\psi = \frac{\mathfrak{I}}{R_a} = \frac{150}{3.183 \times 10^7}$

$$F_2 = I_2 dl_2 \cdot B_1 = I_2 dl_2 \frac{\psi_1}{S} = \frac{2 \times 10^{-3} \times 5 \times 10^{-3} \times 150}{3.183 \times 10^7 \times 25 \times 10^{-6}}$$

$$F_2 = \underline{\underline{1.885 \text{ nN}}}$$

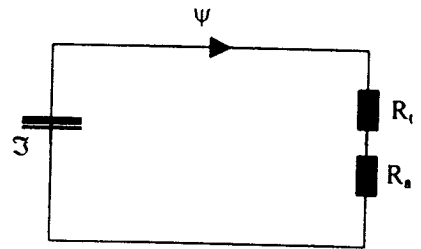
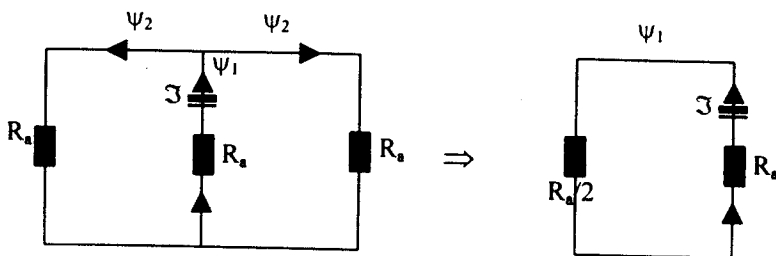
**Prob. 8.42**

$$\psi_1 = 2\psi_2, \psi_1 = \frac{\mathfrak{I}}{3/2 R_a} = \frac{2\mathfrak{I}}{3R_a} \rightarrow \psi_2 = \frac{\mathfrak{I}}{3R_a}$$

$$\mathfrak{I} = 2 \left(\frac{\psi_2^2}{2\mu_0 S} \right) + \frac{\psi_1}{2\mu_0 S} = \frac{3\psi_1^2}{\mu_0 S} = \frac{\mathfrak{I}^2}{3R_a^2 \mu_0^2}$$

$$= \frac{\mu_0 S \mathfrak{I}^2}{3l_a^2} = \frac{4\pi \times 10^{-7} \times 210 \times 10^{-4} \times 9 \times 10^6}{3 \times 10^6}$$

$$= 24\pi \times 10^3 = mg \rightarrow m = \frac{24\pi \times 10^3}{9.8} = \underline{\underline{7694}} \text{ kg}$$

Prob. 8.43

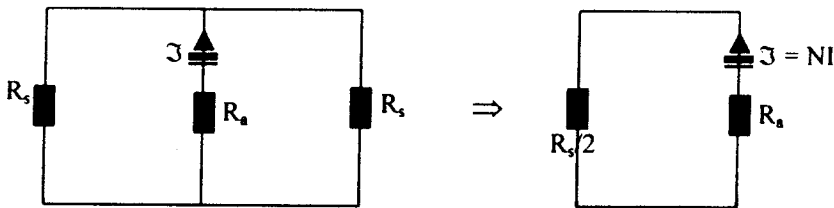

Since $\mu \rightarrow \infty$ for the core, $R_c = 0$.

$$\mathfrak{I} = NI = \psi \left(R_a + \frac{R_s}{2} \right) = \frac{\psi(a/2 + x)}{\mu_0 S}$$

$$= \frac{\psi(2x + a)}{2\mu_0 S}$$

$$\mathfrak{I} = \frac{B^2 S}{2\mu_0} = \psi \frac{4}{2\mu_0 S} = \frac{1}{2\mu_0 S} \cdot \frac{N^2 I^2 4\mu_0 S^2}{(a + 2x)^2}$$

$$= \frac{2N^2 I^2 \mu_0 S}{(a + 2x)^2}$$

$\vec{F} = -F\vec{a}_x$ since the force is attractive, i.e.

$$\vec{F} = \frac{-2N^2 I^2 \mu_0 S \vec{a}_x}{(a + 2x)^2}$$

CHAPTER 9

P.E. 9.1

$$(a) \quad V_{emf} = \int (\bar{u} \times \bar{B}) \cdot \partial \bar{l} = uBl = 8(0.5)(0.1) = \underline{0.4} \text{ V}$$

$$(b) \quad I = \frac{V_{emf}}{R} = \frac{0.4}{20} = \underline{20} \text{ mA}$$

$$(c) \quad \bar{F}_m = I\bar{l} \times \bar{B} = 0.2(0.1\bar{a}_y \times -0.5\bar{a}_z) = \underline{-\bar{a}_x} \text{ mN}$$

$$(d) \quad P = FU = I^2R = 8 \text{ mW}$$

$$\text{or} \quad P = \frac{V_{emf}^2}{R} = \frac{(0.4)^2}{20} = \underline{8} \text{ mW}$$

P.E. 9.2

$$(a) \quad V_{emf} = \int (\bar{u} \times \bar{B}) \cdot \partial \bar{l}$$

$$\text{where } \bar{B} = B_o \bar{a}_y = B_o (\sin \phi \bar{a}_o + \cos \phi \bar{a}_z), \quad B_o = 0.05$$

$$(\bar{u} \times \bar{B}) \cdot \partial \bar{l} = -\rho \omega B_o \sin \phi \partial z = -0.2\pi \sin(\omega t + \pi/2) \partial z$$

$$V_{emf} = \int_0^{0.03} (\bar{u} \times \bar{B}) \cdot \partial \bar{l} = -6\pi \cos(100\pi t) \text{ mV}$$

At $t = 1 \text{ ms}$,

$$V_{emf} = -6\pi \cos 0.1\pi = \underline{-17.93} \text{ mV}$$

$$i = \frac{V_{emf}}{R} = -60\pi \cos(100\pi t) \text{ mA}$$

$$\text{At } t = 3 \text{ ms}, \quad i = -60\pi \cos 0.3\pi = \underline{-0.1108} \text{ A}$$

(b) Method 1:

$$\Psi = \int \bar{B} \cdot \partial \bar{l} = \int B_o t (\cos \phi \bar{a}_\phi - \sin \phi \bar{a}_\phi) \cdot \partial \rho \partial z \bar{a}_\phi = - \int_0^{\rho_o} \int_0^{z_o} B_o t \sin \phi \partial \rho \partial z = -B_o \rho_o z_o t \sin \phi$$

where $B_o = 0.02$, $\rho_o = 0.04$, $z_o = 0.03$

$$\phi = \omega t + \pi/2$$

$$\Psi = -B_o \rho_o z_o t \cos \omega t$$

$$V_{emf} = - \frac{\partial \Psi}{\partial t} = B_o \rho_o z_o \cos \omega t - B_o \rho_o z_o t \sin \omega t$$

$$= (0.02)(0.04)(0.03)[\cos wt - wt \sin wt]$$

$$= 24[\cos wt - wt \sin wt] \mu V$$

Method 2:

$$V_{emf} = - \int \frac{\partial \vec{B}}{\partial t} \cdot d\vec{s} + \int (\vec{u} \times \vec{B}) \cdot d\vec{l}$$

$$\vec{B} = B_o t \vec{a}_x = B_o t (\cos \phi \vec{a}_p - \sin \phi \vec{a}_p), \phi = wt + \pi/2$$

$$\frac{\partial \vec{B}}{\partial t} = B_o (\cos \phi \vec{a}_p - \sin \phi \vec{a}_p)$$

Note that only explicit dependence of \vec{B} on time is accounted for, i.e. we make ϕ

= constant because it is transformer (stationary) emf. Thus,

$$V_{emf} = -B_o \int_0^{\rho_o z_o} \int_0^{\rho_o} (\cos \phi \vec{a}_p - \sin \phi \vec{a}_p) \rho d\rho dz + \int_{z_o}^0 -\rho_o w B_o t \cos \phi dz$$

$$= B_o \rho_o z_o (\sin \phi + wt \cos \phi), \phi = wt + \pi/2$$

$$= B_o \rho_o z_o (\cos wt + wt \sin wt) \text{ as obtained earlier.}$$

At $t = 1 \text{ ms}$,

$$V_{emf} = 24[\cos 18^\circ - 100\pi \times 10^{-3} \sin 18^\circ] \mu V$$

$$= \underline{\underline{20.5 \mu V}}$$

At $t = 3 \text{ ms}$,

$$i = 240[\cos 54^\circ - .03\pi \sin 54^\circ] \text{ mA}$$

$$= \underline{\underline{-41.92 \text{ mA}}}$$

P.E. 9.3

$$V_1 = -N_1 \frac{d\psi}{dt}, V_2 = -N_2 \frac{d\psi}{dt}$$

$$\frac{V_2}{V_1} = \frac{N_2}{N_1} \rightarrow V_2 = \frac{N_2}{N_1} V_1 = \frac{300 \times 120}{500} = \underline{\underline{72V}}$$

P.E. 9.4

$$(a) \quad \vec{J}_a = \frac{\partial \vec{D}}{\partial t} = \underline{\underline{-20w\epsilon_o \sin(wt - 50x) \vec{a}_1, A/m^2}}$$

$$(b) \quad \nabla \times \vec{H} = \vec{J}_a \rightarrow -\frac{\partial \vec{H}_z}{\partial x} \vec{a}_1 = -20w\epsilon_o \sin(wt - 50x) \vec{a}_1,$$

$$\text{or } \vec{H} = \frac{20w\epsilon_0}{50} \cos(\omega t - 50x) \vec{a}_z$$

$$= \underline{\underline{0.4w\epsilon_0 \cos(\omega t - 50x) \vec{a}_z}} \text{ A/m}$$

$$(c) \quad \nabla \times \vec{E} = -\mu_0 \frac{\partial \vec{H}}{\partial t} \rightarrow -\frac{\partial \vec{E}_z}{\partial x} \vec{a}_z = 0.4\mu_0 w \epsilon_0 \sin(\omega t - 50x) \vec{a}_z$$

$$1000 = 0.4\mu_0 \epsilon_0 w^2 = 0.4 \frac{u^2}{c^2}$$

$$\text{or } w = \underline{\underline{1.5 \times 10^{10} \text{ rad/s}}}$$

P.E. 9.5

$$(a) \quad j^3 \left(\frac{1+j}{2-j} \right)^2 = -j \left[\frac{\sqrt{2} \angle 45^\circ}{\sqrt{5} \angle -26.56^\circ} \right]^2 = -j \left(\frac{2}{5} \angle 143.13^\circ \right)$$

$$= \underline{\underline{0.24 + j0.32}}$$

$$(b) \quad 6 \angle 30^\circ + j5 - 3 + e^{j45^\circ} = 5.196 + j3 + j5 - 3 + 0.7071(1+j)$$

$$= \underline{\underline{2.903 + j8.707}}$$

P.E. 9.6

$$\vec{P} = 2 \sin(10t + x - \pi/4) \vec{a}_y = 2 \cos(10t + x - \pi/4 - \pi/2) \vec{a}_y, \quad w = 10$$

$$= R_e \left(2e^{j(x-3\pi/4)} \vec{a}_y e^{j\omega t} \right) = R_e \left(\vec{P}_s e^{j\omega t} \right)$$

$$\text{i.e. } \underline{\underline{P_s = 2e^{j(x-3\pi/4)} \vec{a}_y}}$$

$$\vec{Q} = R_e \left(\vec{Q}_s e^{j\omega t} \right) = R_e \left(e^{j(x+\omega t)} (\vec{a}_x - \vec{a}_z) \right) \sin \pi y$$

$$= \underline{\underline{\sin \pi y \cos(\omega t + x) (\vec{a}_x - \vec{a}_z)}}$$

P.E. 9.7

$$-\mu \frac{\partial \vec{H}}{\partial t} = \nabla \times \vec{E} = \frac{1}{r \sin \theta} \frac{\partial}{\partial \theta} (E_\phi \sin \theta) \vec{a}_r - \frac{1}{r} \frac{\partial}{\partial r} (r E_\phi) \vec{a}_\theta$$

$$= \frac{2 \cos \theta}{r^2} \cos(\omega t - \beta r) \vec{a}_r - \frac{\beta}{r} \sin \theta \sin(\omega t - \beta r) \vec{a}_\theta$$

$$\vec{H} = \frac{2 \cos \theta}{wr^2} \sin(\omega t - \beta r) \vec{a}_r + \frac{\beta}{wr} \sin \theta \cos(\omega t - \beta r) \vec{a}_\theta$$

$$\beta = \frac{w}{c} = \frac{6 \times 10^7}{3 \times 10^8} = \underline{\underline{0.2}} \text{ rad/m}$$

$$\underline{\underline{\vec{H} = \frac{10^{-7}}{3r^2} \cos \theta \sin(6 \times 10^7 - 0.2r) \vec{a}_r + \frac{10^{-8}}{3r} \sin \theta \cos(6 \times 10^7 - 0.2r) \vec{a}_\theta}}$$

P.E. 9.8

$$\omega = \frac{3}{\sqrt{\mu\epsilon}} = \frac{3c}{\sqrt{\mu_r\epsilon_r}} = \frac{9 \times 10^8}{\sqrt{10}} = \underline{\underline{2.846 \times 10^8}} \text{ rad/s}$$

$$\begin{aligned} \vec{E} &= \frac{1}{\epsilon} \int \nabla \times \vec{H} dt = -\frac{6}{w\epsilon} \cos(\omega t - 3y) \vec{a}_x \\ &= \frac{-6}{\frac{9 \times 10^8}{\sqrt{10}} \cdot \frac{10^{-9}}{36}} \cos(\omega t - 3y) \vec{a}_x \quad (5) \end{aligned}$$

$$\underline{\underline{\vec{E} = -476.8 \cos(2.846 \times 10^8 t - 3y) \vec{a}_x}} \text{ V/m}$$

Prob. 9.1

$$V = -\frac{\partial \psi}{\partial t} = -\frac{\partial}{\partial t} \int \vec{B} \cdot d\vec{S} = -\frac{\partial \vec{B}}{\partial t} \cdot \vec{S}$$

$$= 3770 \sin 377t \times \pi(0.2)^2 \times 10^{-3}$$

$$= \underline{\underline{0.4738 \sin 377t}} \text{ V}$$

$$\text{Prob. 9.2} \quad V_{emf} = \int (\vec{u} \times \vec{B}) \cdot d\vec{l}, \quad d\vec{l} = d\rho \vec{a}_\rho, \quad \vec{u} = \rho \frac{d\phi}{dt} = \rho w \vec{a}_\phi$$

$$\vec{u} \times \vec{B} = \rho w \vec{a}_\phi \times B_0 \vec{a}_z = B_0 \rho w \vec{a}_\rho$$

$$V_{emf} = \int_{\rho=0}^l B_0 \rho w \vec{a}_\rho \cdot d\rho \vec{a}_\rho = B_0 w \left. \frac{\rho^2}{2} \right|_0^l = \frac{1}{2} B_0 w l^2$$

$$V_{emf} = \underline{\underline{\frac{1}{2} B_0 w l^2}}$$

Prob. 9.3

$$V_{emf} = -\frac{\partial \lambda}{\partial t} = -W \frac{\partial}{\partial t} \int \vec{B} \cdot d\vec{S} = -NBS \frac{d\phi}{dt}$$

$$= -NBSW = -50 \times 0.06 \times 0.3 \times 0.4 = \underline{\underline{-54}} \text{ V}$$

Prob. 9.4 $\psi = \int \vec{B} \cdot d\vec{S} = BS$

$$V_{emf} = -\frac{d\psi}{dt} = -\frac{dB}{dt}S = +40 \times 10^4 \sin(10^4) \cdot 10^{-3} \times 20 \times 10^{-4}$$

$$= 0.8 \sin 10^4 t$$

$$I = \frac{V_{emf}}{R} = \underline{\underline{0.2 \sin 10^4 t \text{ A}}}$$

I flows clockwise for increasing \vec{B} field.

Prob. 9.5 (a) $v = \int (u \times \vec{B}) \cdot d\vec{l}, d\vec{l} = dy\vec{a}_y,$
 $u \times \vec{B} = 2\vec{a}_x \times 0.1\vec{a}_z = -0.2\vec{a}_y,$

$y = x$ since the angle of the v-shaped conductor is 45° . Hence
 $y = x = ut$. At $t = 0, x = 0 = y$

$$v = -\int 0.2 du = -0.2y, \quad y = ut = 2t$$

$$\underline{\underline{v = -0.4t \text{ V}}}$$

(b) $v = \int (u \times \vec{B}) \cdot d\vec{l}, d\vec{l} = dy\vec{a}_y,$

$$u \times \vec{B} = 2\vec{a}_x \times 0.5x\vec{a}_z = -x\vec{a}_y,$$

But $y = x$ and $x = ut$. When $t = 0, x = 0 = y$

$$v = -\int x dy = -\int y dy = -\frac{y^2}{2}$$

But $x = y = ut = 2t$

$$\underline{\underline{v = -2t^2 \text{ V}}}$$

Prob. 9.6

$$B = \frac{\mu_o I}{2\pi y} (-\vec{a}_x)$$

$$\psi = \int \vec{B} \cdot d\vec{S} = \frac{\mu_o I}{2\pi} \int_{z=0}^a \int_{y=\rho}^{\rho+a} \frac{dz dy}{y} = \frac{\mu_o I a}{2\pi} \ln \frac{\rho+a}{\rho}$$

$$V_{emf} = -\frac{\partial \psi}{\partial t} = -\frac{\partial \psi}{\partial \rho} \cdot \frac{\partial \rho}{\partial t} = -\frac{\mu_o I a}{2\pi} u_o \frac{d}{d\rho} [\ln(\rho+a) - \ln \rho]$$

$$= -\frac{\mu_o I a}{2\pi} u_o \left[\frac{1}{\rho+a} - \frac{1}{\rho} \right] = \underline{\underline{\frac{\mu_o a^2 I u_o}{2\pi \rho(\rho+a)}}}$$

Prob. 9.7 This is similar to Prob. 9.6. Assume loop is of width z .

$$\psi = \frac{\mu_0 I z}{2\pi} \ln \frac{\rho + a}{\rho}$$

$$V_{emf} = -\frac{\partial \psi}{\partial t} = -\frac{\partial \psi}{\partial z} \cdot \frac{\partial z}{\partial t} = -\frac{\mu_0 I}{2\pi} \ln \frac{\rho + a}{\rho} \cdot u$$

$$= -\frac{4\pi \times 10^{-7}}{2\pi} \times 15 \times 3 \ln \frac{60}{20} = -9.888 \mu V$$

Thus the induced emf = 9.888 μ V, point A at higher potential.

Prob. 9.8

$$V_{emf} = -\int \frac{\partial \vec{B}}{\partial t} \cdot d\vec{S} + \int (\vec{u} \times \vec{B}) \cdot d\vec{l}$$

where $\vec{B} = B_0 \cos \omega t \vec{a}_x$, $\vec{u} = u_0 \cos \omega t \vec{a}_y$, $d\vec{l} = dz \vec{a}_z$

$$V_{emf} = \int_{z=0}^l \int_{y=-a}^y B_0 \omega \sin \omega t dy dz - \int_0^l B_0 u_0 \cos^2 \omega t dz$$

$$= B_0 \omega l (y+a) \sin \omega t - B_0 u_0 l \cos^2 \omega t$$

Alternatively,

$$\psi = \int \vec{B} \cdot d\vec{s} = \int_{z=0}^l \int_{y=-a}^y B_0 \cos \omega t \vec{a}_x \cdot dy dz \vec{a}_x = B_0 (y+a) l \cos \omega t$$

$$V_{emf} = -\frac{\partial \psi}{\partial t} = B_0 (y+a) l \omega \sin \omega t - B_0 \frac{dy}{dt} l \cos \omega t$$

$$\text{But } \frac{dy}{dt} = u = u_0 \cos \omega t \rightarrow y = \frac{u_0}{\omega} \sin \omega t$$

$$V_{emf} = B_0 \omega l (y+a) \sin \omega t - B_0 u_0 l \cos^2 \omega t$$

$$= B_0 u_0 l \sin^2 \omega t + B_0 \omega a l \sin \omega t - B_0 u_0 l \cos^2 \omega t$$

$$= -B_0 u_0 l \cos 2\omega t + B_0 \omega a l \sin \omega t$$

$$= 6 \times 10^{-3} \times 5 [10 \times 10 \sin 10t - 2 \cos 20t]$$

$$V_{emf} = \underline{3 \sin 10t - 0.06 \cos 20t} \text{ V}$$

Prob. 9.9

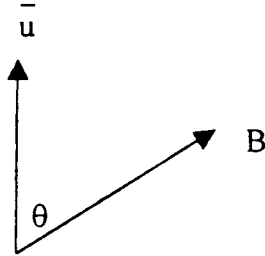
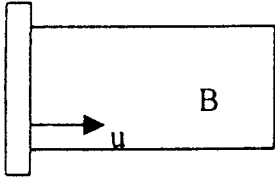

$$\begin{aligned}
 V_{\text{emf}} &= \int (\vec{u} \times \vec{B}) \cdot d\vec{l} = uBl \cos \theta \\
 &= \left(\frac{120 \times 10^3}{3600} \text{ m/s} \right) (4.3 \times 10^{-5}) (1.6) \cos 65^\circ \\
 &= 2.293 \cos 65^\circ = \underline{\underline{0.97 \text{ mV}}}
 \end{aligned}$$

Prob. 9.10

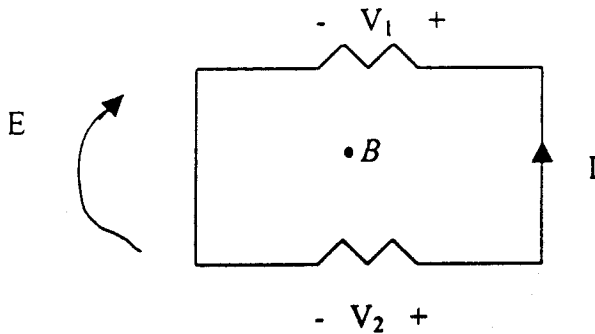

$$\oint \vec{E} \cdot d\vec{l} = - \frac{d}{dt} \int \vec{B} \cdot d\vec{S}$$

$$= I(R_1 + R_2)$$

$$\frac{dB}{dt} \cdot S = I(R_1 + R_2) \quad (1)$$

$$\text{Also, } \oint \vec{E} \cdot d\vec{l} = V_1 - V_2 = - \frac{dB}{dt} \cdot S \quad (2)$$

$$\text{Hence, } V_1 = IR_1 = - \frac{SR_1}{R_1 + R_2} \frac{dB}{dt}$$

$$V_2 = -IR_2 = \frac{SR_2}{R_1 + R_2} \frac{dB}{dt}$$

$$V_1 = \frac{10 \times 10^{-4} \times 10}{15} \times 0.2 \times 150\pi \sin 150\pi t = \underline{\underline{0.0628 \sin 150\pi t}}$$

$$V_2 = \frac{-10 \times 10^{-4} \times 5}{15} \times 0.2 \times 150\pi \sin 150\pi t = \underline{\underline{-0.0314 \sin 150\pi t}}$$

Prob. 9.11

$$d\psi = 0.63 - 0.45 = 0.18, dt = 0.02$$

$$V_{emf} = N \frac{d\psi}{dt} = 10 \left(\frac{0.18}{0.02} \right) = 90V$$

$$I = \frac{V_{emf}}{R} = \left(\frac{90}{15} \right) = \underline{6} \text{ A}$$

Using Lenz's law, the direction of the induced current is counterclockwise.

Prob. 9.12

$$V = \int (\vec{u} \times \vec{B}) \cdot d\vec{l}, \text{ where } \vec{u} = \rho\omega\vec{a}_\phi, \vec{B} = B_0\vec{a}_z$$

$$V = \int_{\rho_2}^{\rho_1} \rho\omega B_0 c' r = \frac{\omega B_0}{2} (\rho^2_2 - \rho^2_1)$$

$$V = \frac{60 \times 5}{2} \cdot 10^{-3} (100 - 4) \cdot 10^{-4} = \underline{4.32} \text{ mV}$$

Prob. 9.13

$$J_{ds} = j\omega D_s \rightarrow |J_{ds}|_{\max} = \omega\epsilon E_s = \omega\epsilon \frac{V_s}{d}$$

$$= \frac{10^{-9}}{36\pi} \times \frac{2\pi \times 20 \times 10^6 \times 50}{0.2 \times 10^{-3}}$$

$$= \underline{277.8} \text{ A/m}^2$$

$$I_{ds} = J_{ds} \cdot S = \frac{1000}{3.6} \times 2.8 \times 10^{-4} = \underline{77.78} \text{ mA}$$

Prob. 9.14

$$\frac{J_c}{J_d} = \frac{\sigma E}{\omega\epsilon E} = \frac{\sigma}{\omega\epsilon}$$

$$(a) \frac{\sigma}{\omega\epsilon} = \frac{2 \times 10^{-3}}{2\pi \times 10^9 \times 81 \times \frac{10^{-9}}{36\pi}} = \underline{0.444 \times 10^{-3}}$$

$$(b) \frac{\sigma}{\omega\epsilon} = \frac{25}{2\pi \times 10^9 \times 81 \times \frac{10^{-9}}{36\pi}} = \underline{5.555}$$

$$(c) \frac{\sigma}{\omega \epsilon} = \frac{2 \times 10^{-4}}{2\pi \times 10^9 \times 5 \times \frac{10^{-9}}{36\pi}} = \underline{\underline{7.2 \times 10^{-4}}}$$

$$\text{Prob. 9.15} \quad \frac{J}{J_d} = \frac{\sigma E}{\omega \epsilon E} = \frac{\sigma}{\omega \epsilon} = 10$$

$$\omega = \frac{\sigma}{10 \epsilon} = 2\pi f \quad \longrightarrow \quad f = \frac{\sigma}{20\pi \epsilon} = \frac{20}{20\pi \times \frac{10^{-9}}{36\pi}}$$

$$f = \underline{\underline{36 \text{ GHz}}}$$

Prob. 9.16

$$J_c = \frac{I_c}{S} = \sigma E \rightarrow E = \frac{I_c}{\sigma S}$$

$$J_a = j\omega \epsilon E \rightarrow |J_a| = \omega \epsilon E = \frac{\omega I_c}{\sigma S}$$

$$|J_d| = \frac{10^9 \times 4.6 \times 10^{-9} / 36\pi \times 0.2 \times 10^{-3}}{25 \times 10^6 \times 10 \times 10^{-4}} \text{ A/m} = \underline{\underline{3.254 \text{ nA/m}^2}}$$

Prob. 9.17

$$(a) \quad \nabla \cdot \vec{E}_s = \rho_s / \epsilon, \quad \nabla \cdot \vec{H}_s = 0$$

$$\underline{\underline{\nabla \times \vec{E}_s = j\omega \mu \vec{H}_s, \quad \nabla \times \vec{H}_s = (\sigma - j\omega \epsilon) \vec{E}_s}}$$

$$(b) \quad \nabla \cdot \vec{D} = \rho_v \rightarrow \frac{\partial D_x}{\partial x} + \frac{\partial D_y}{\partial y} + \frac{\partial D_z}{\partial z} = \rho_v \quad (1)$$

$$\nabla \cdot \vec{B} = 0 \rightarrow \frac{\partial B_x}{\partial x} + \frac{\partial B_y}{\partial y} + \frac{\partial B_z}{\partial z} = 0 \quad (2)$$

$$\nabla \times \vec{E} = -\frac{\partial \vec{B}}{\partial t} \rightarrow \frac{\partial E_z}{\partial y} - \frac{\partial E_y}{\partial z} = -\frac{\partial B_x}{\partial t} \quad (3)$$

$$\frac{\partial E_x}{\partial z} - \frac{\partial E_z}{\partial x} = -\frac{\partial B_y}{\partial t} \quad (4)$$

$$\frac{\partial E_y}{\partial x} - \frac{\partial E_x}{\partial y} = -\frac{\partial B_z}{\partial t} \quad (5)$$

$$\nabla \times \vec{H} = \vec{J} + \frac{\partial \vec{D}}{\partial t} \rightarrow \frac{\partial H_z}{\partial y} - \frac{\partial H_y}{\partial z} = J_x + \frac{\partial D_x}{\partial t} \quad (6)$$

$$\frac{\partial H_x}{\partial z} - \frac{\partial H_z}{\partial x} = J_y + \frac{\partial D_y}{\partial t} \quad (7)$$

$$\frac{\partial H_y}{\partial x} - \frac{\partial H_x}{\partial y} = J_z + \frac{\partial D_z}{\partial t} \quad (8)$$

Prob. 9.18

If $\vec{J} = 0 = \rho_v$, then $\nabla \cdot \vec{B} = 0$ (1)

$$\nabla \cdot \vec{D} = \rho_v \quad (2)$$

$$\nabla \times \vec{E} = -\frac{\partial \vec{B}}{\partial t} \quad (3)$$

$$\nabla \times \vec{H} = \vec{J} + \frac{\partial \vec{D}}{\partial t} \quad (4)$$

Since $\nabla \cdot \nabla \times \vec{A} = 0$ for any vector field \vec{A} ,

$$\nabla \cdot \nabla \times \vec{E} = -\frac{\partial}{\partial t} \nabla \cdot \vec{B} = 0$$

$$\nabla \cdot \nabla \times \vec{H} = -\frac{\partial}{\partial t} \nabla \cdot \vec{D} = 0$$

showing that (1) and (2) are incorporated in (3) and (4). Thus Maxwell's equations can be reduced to (3) and (4), i.e.

$$\underline{\underline{\nabla \times \vec{E} = -\frac{\partial \vec{B}}{\partial t}, \nabla \times \vec{H} = \frac{\partial \vec{D}}{\partial t}}}$$

Prob. 9.19

$$-\frac{\partial \rho_v}{\partial t} = \nabla \cdot \vec{J} = \nabla \cdot \sigma \vec{E} = \sigma \nabla \cdot \frac{D}{\epsilon} = \frac{\sigma}{\epsilon} \rho_v$$

Hence,

$$\underline{\underline{\frac{\partial \rho_v}{\partial t} + \frac{\sigma}{\epsilon} \rho_v = 0}}$$

Prob. 9.20

$$\nabla_x E = -\frac{\partial B}{\partial t}$$

$$\nabla_x \nabla_x E = -\frac{\partial}{\partial t} \nabla_x B = -\mu \frac{\partial}{\partial t} \nabla_x H = -\mu \frac{\partial J}{\partial t}$$

But

$$\nabla_x \nabla_x E = \nabla(\nabla \cdot E) - \nabla^2 E$$

$$\nabla(\nabla \cdot E) - \nabla^2 E = -\mu \frac{\partial J}{\partial t}, \quad J = \sigma E$$

In a source-free region, $\nabla \cdot E = \rho_v / \epsilon = 0$. Thus,

$$\underline{\underline{\nabla^2 E = \mu \sigma \frac{\partial E}{\partial t}}}$$

Prob. 9.21

$$\nabla \cdot J = (0 + 0 + 3z^2) \sin 10^4 t = -\frac{\partial \rho_v}{\partial t}$$

$$\rho_v = \int \nabla \cdot J dt = \int 3z^2 \sin 10^4 t dt = -\frac{3z^2}{10^4} \sin 10^4 t + C_0$$

If $\rho_v|_{z=0} = 0$, then $C_0 = 0$ and

$$\underline{\underline{\rho_v = -0.3z^2 \sin 10^4 t \text{ mC/m}^3}}$$

Prob. 9.22 (a)

$$J_d = \nabla \times H = \begin{vmatrix} \frac{\partial}{\partial x} & \frac{\partial}{\partial y} & \frac{\partial}{\partial z} \\ 0 & 0 & H_z(y, t) \end{vmatrix} = \frac{\partial H_z}{\partial y} a_x = \underline{\underline{20 \sin(10^9 t - 4y) a_x \text{ A/m}}}$$

But $J_d = \frac{\partial D}{\partial t}$.

$$D = \int J_d dt = -\frac{20}{10^9} \cos(10^9 t - 4y) a_x = \underline{\underline{-20 \cos(10^9 t - 4y) a_x \text{ nC/m}^2}}$$

(b) $\nabla \times E = -\mu \frac{\partial H}{\partial t} = \nabla \times \frac{D}{\epsilon}$

$$\frac{1}{\epsilon} \begin{vmatrix} \frac{\partial}{\partial x} & \frac{\partial}{\partial y} & \frac{\partial}{\partial z} \\ D_x(y, t) & 0 & 0 \end{vmatrix} = -\frac{1}{\epsilon} \left(\frac{-20}{10^9} \right) (-4) \sin(10^9 t - 4y) a_x$$

$$-\frac{1}{\epsilon} \left(\frac{80}{10^9} \right) \sin(10^9 t - 4y) \mathbf{a}_z = -5\mu \times 10^9 \sin(10^9 t - 4y) \mathbf{a}_z$$

$$\frac{80}{10^9 \epsilon_0 \epsilon_r} = 5\mu \times 10^9 \quad \longrightarrow \quad \epsilon_r = \frac{80}{5 \times 4\pi \times 10^{-7} \times 10^{18} \times \frac{10^{-9}}{36\pi}} = \underline{\underline{1.44}}$$

Prob. 9.23

$$\epsilon \frac{\partial \vec{E}}{\partial t} = \nabla \times \vec{H} = \begin{vmatrix} \frac{\partial}{\partial x} & \frac{\partial}{\partial y} & \frac{\partial}{\partial z} \\ 0 & 0 & H_z \end{vmatrix} = -\frac{\partial H_z}{\partial x} \mathbf{a}_y$$

$$= 0.6\beta \sin \beta x \cos \omega t \mathbf{a}_y$$

$$E = \frac{1}{\epsilon} \int \nabla \times \vec{H} dt = \frac{0.6\beta}{\omega \epsilon} \sin \beta x \sin \omega t \mathbf{a}_y$$

$$\nabla \times \vec{E} = -\mu \frac{\partial \vec{H}}{\partial t} = \begin{vmatrix} \frac{\partial}{\partial x} & \frac{\partial}{\partial y} & \frac{\partial}{\partial z} \\ 0 & E_y & 0 \end{vmatrix} = -\frac{\partial E_y}{\partial x} \mathbf{a}_z$$

$$= \frac{0.6\beta^2}{\omega \epsilon} \cos \beta x \sin \omega t \mathbf{a}_z$$

$$\vec{H} = -\frac{1}{\mu} \int \nabla \times \vec{E} dt = \frac{0.6\beta^2}{\omega^2 \mu \epsilon} \cos \beta x \cos \omega t \mathbf{a}_z$$

$$\text{Thus } \beta = \omega \sqrt{\mu \epsilon} = \frac{\omega}{c} \sqrt{\mu_r \epsilon_r} = \frac{10^8 (2.25)}{3 \times 10^8} \\ = \underline{\underline{0.8333 \text{ rad/m}}}$$

$$E_o = \frac{0.6\beta}{\omega \epsilon} = \frac{0.6\omega \sqrt{\mu \epsilon}}{\omega \epsilon} = 0.6 \sqrt{\frac{\mu}{\epsilon}} = 0.6(377) \sqrt{\frac{\mu_r}{\epsilon_r}}$$

$$= \frac{0.6 \times 377}{2.25} = 100.5$$

$$\underline{\underline{\vec{E} = 100.5 \sin \beta x \sin \omega t \mathbf{a}_y \text{ V/m}}}$$

Prob. 9.24

$$\nabla \times E = -\frac{\partial B}{\partial t} = -\mu_0 \frac{\partial H}{\partial t}$$

$$\nabla \times E = \begin{vmatrix} \frac{\partial}{\partial x} & \frac{\partial}{\partial y} & \frac{\partial}{\partial z} \\ 0 & E_y(x) & E_z(x) \end{vmatrix} = -\frac{\partial E_z}{\partial x} a_y + \frac{\partial E_y}{\partial x} a_z = 40 \times 8 \cos(10^9 t - 8x) a_y + 50 \times 8 \sin(10^9 t - 8x) a_z$$

$$H = -\frac{1}{\mu_0} \int \nabla \times E dt = -\frac{10^{-9}}{\mu_0} [40 \times 8 \sin(10^9 t - 8x) a_y - 50 \times 8 \cos(10^9 t - 8x) a_z]$$

$$= -\frac{10^{-2}}{4\pi} [320 \sin(10^9 t - 8x) a_y - 400 \cos(10^9 t - 8x) a_z]$$

$$H = \underline{\underline{-0.2546 \sin(10^9 t - 8x) a_y + 0.3184 \cos(10^9 t - 8x) a_z \text{ A/m}}}$$

$$\beta = \omega \sqrt{\mu \epsilon} = \frac{\omega}{c} \sqrt{\mu_r \epsilon_r}, \quad (\mu_r = 1) \quad \longrightarrow \quad \sqrt{\epsilon_r} = \frac{\beta c}{\omega} = \frac{8 \times 3 \times 10^8}{10^9} = 2.4$$

$$\underline{\underline{\epsilon_r = 576}}$$

Prob. 9.25 (a) $\nabla \cdot A = 0$

$$\nabla \cdot A = \begin{vmatrix} \frac{\partial}{\partial x} & \frac{\partial}{\partial y} & \frac{\partial}{\partial z} \\ 0 & 0 & E_z(x, t) \end{vmatrix} = -\frac{\partial E_z(x, t)}{\partial x} a_y \neq 0$$

Yes, A is a possible EM field.

(b) $\nabla \cdot B = 0$

$$\nabla \cdot B = \frac{1}{\rho} \frac{\partial}{\partial \rho} [10 \cos(\omega t - 2\rho)] a_z \neq 0$$

Yes, B is a possible EM field.

$$(c) \quad \nabla \cdot C = \frac{1}{\rho} \frac{\partial}{\partial \rho} (3\rho^3 \cot \phi) - \frac{\sin \phi}{\rho^2} \neq 0$$

$$\nabla \cdot C = \frac{1}{\rho} \frac{\partial}{\partial \rho} (\cos \phi \sin \omega t) - 3\rho^2 \frac{\partial}{\partial \phi} (\cot \phi) \neq 0$$

No, C is not an EM field.

$$(d) \quad \nabla \cdot D = \frac{l}{r^2 \sin \theta} \sin(\omega t - 5r) \frac{\partial}{\partial \theta} (\sin^2 \theta) \neq 0$$

$$\nabla \times D = -\frac{\partial D_\theta}{\partial \phi} a_r + \frac{l}{r} \frac{\partial}{\partial r} (r D_\theta) a_\phi = \frac{l}{r} \sin \theta (-5) \sin(\omega t - 5r) a_\phi \neq 0$$

No, D is not an EM field.

Prob. 9.26 From Maxwell's equations,

$$\nabla \times \bar{E} = -\frac{\partial \bar{B}}{\partial t} \quad (1)$$

$$\nabla \times \bar{H} = \bar{J} + \frac{\partial \bar{D}}{\partial t} \quad (2)$$

Dotting both sides of (2) with \bar{E} gives:

$$\bar{E} \cdot (\nabla \times \bar{H}) = \bar{E} \cdot \bar{J} + \bar{E} \cdot \frac{\partial \bar{D}}{\partial t} \quad (3)$$

But for any arbitrary vectors \bar{A} and \bar{B} ,

$$\nabla \cdot (\bar{A} \times \bar{B}) = \bar{B} \cdot (\nabla \times \bar{A}) - \bar{A} \cdot (\nabla \times \bar{B})$$

Applying this on the left-hand side of (3) by letting $\bar{A} \equiv \bar{B}$ and $\bar{B} \equiv \bar{E}$, we get

$$\bar{H} \cdot (\nabla \times \bar{E}) + \nabla \cdot (\bar{H} \times \bar{E}) = \bar{E} \cdot \bar{J} + \frac{1}{2} \frac{\partial}{\partial t} (\bar{D} \cdot \bar{E}) \quad (4)$$

From (1),

$$\bar{H} \cdot (\nabla \times \bar{E}) = \bar{H} \cdot \left(-\frac{\partial \bar{B}}{\partial t} \right) = \frac{1}{2} \frac{\partial}{\partial t} (\bar{B} \cdot \bar{H})$$

Substituting this in (4) gives:

$$-\frac{1}{2} \frac{\partial}{\partial t} (\bar{B} \cdot \bar{H}) - \nabla \cdot (\bar{E} \times \bar{H}) = \bar{J} \cdot \bar{E} + \frac{1}{2} \frac{\partial}{\partial t} (\bar{D} \cdot \bar{E})$$

Rearranging terms and then taking the volume integral of both sides:

$$\int_V \nabla \cdot (\bar{E} \times \bar{H}) dv = -\frac{\partial}{\partial t} \frac{1}{2} \int_V (\bar{E} \cdot \bar{D} + \bar{H} \cdot \bar{B}) dv - \int_V \bar{J} \cdot \bar{E} dv$$

$$\oint_S (\bar{E} \times \bar{H}) \cdot d\bar{S} = -\frac{\partial w}{\partial t} - \int_V \bar{J} \cdot \bar{E} dv$$

$$\text{or } \frac{\partial w}{\partial t} = -\oint_S (\bar{E} \times \bar{H}) \cdot d\bar{S} - \int_V \bar{E} \cdot \bar{J} dv \text{ as required.}$$

Prob. 9.27 $\nabla \times H = J + J_d$

$J = \sigma E = 0$ in free space.

$$J_z = \nabla \times H = \left[\frac{1}{\rho} \frac{\partial H_z}{\partial \phi} - \frac{\partial H_\phi}{\partial z} \right] a_\rho - \left[\frac{\partial H_z}{\partial z} - \frac{\partial H_\rho}{\partial \rho} \right] a_\phi - \frac{1}{\rho} \left[\frac{\partial}{\partial \rho} (\rho H_\phi) - \frac{\partial H_\rho}{\partial \phi} \right] a_z$$

$$= 0 + \frac{1}{\rho} \left[\frac{\partial}{\partial \rho} (2\rho^2 \cos \phi) - \rho \cos \phi \right] \cos 4 \times 10^6 t a_z = \frac{a_z}{\rho} (4 \cos \phi - \rho \cos \phi) \cos 4 \times 10^6 t$$

$$J_d = \underline{\underline{3 \cos \phi \cos 4 \times 10^6 t a_z}}$$

$$J_d = \frac{\partial D}{\partial t} = \epsilon_0 \frac{\partial E}{\partial t} \quad \longrightarrow \quad E = \frac{1}{\epsilon_0} \int J_d dt$$

$$E = \frac{3 \cos \phi}{\epsilon_0 4 \times 10^6} \sin 4 \times 10^6 t a_z = \frac{3}{4 \times 10^6 \times \frac{10^{-9}}{36\pi}} \cos \phi \sin 4 \times 10^6 t a_z$$

$$E = \underline{\underline{84.82 \cos \phi \sin 4 \times 10^6 t a_z}} \text{ kV/m}$$

Prob. 9.28 Using Maxwell's equations,

$$\nabla \times H = \sigma E + \epsilon \frac{\partial E}{\partial t} \quad (\sigma = 0) \quad \longrightarrow \quad E = \frac{1}{\epsilon} \int \nabla \times H dt$$

But

$$\nabla \times H = -\frac{1}{r \sin \theta} \frac{\partial H_\theta}{\partial \phi} a_r + \frac{1}{r} \frac{\partial}{\partial r} (r H_\theta) a_\phi = \frac{12 \sin \theta}{r} \beta \sin(2\pi \times 10^8 t - \beta r) a_\phi$$

$$E = \frac{12 \sin \theta}{\epsilon_0} \beta \int \sin(2\pi \times 10^8 t - \beta r) dt a_\phi$$

$$= \underline{\underline{-\frac{12 \sin \theta}{\omega \epsilon_0 r} \beta \sin(\omega t - \beta r) a_\phi}}, \quad \omega = 2\pi \times 10^8$$

Prob. 9.29

$$\begin{aligned} \nabla \times \vec{E} &= \frac{1}{\rho} \frac{\partial}{\partial \rho} (\rho E_\phi) \vec{a}_z = \frac{1}{\rho} \frac{\partial}{\partial \rho} (\rho^2 + e^{-\rho^{-1}}) \vec{a}_z \\ &= (2 - \rho) t e^{-\rho^{-1}} \vec{a}_z \end{aligned}$$

$$\frac{\partial \vec{B}}{\partial t} = \nabla \times \vec{E} \rightarrow \vec{B} = - \int \nabla \times \vec{E} dt = \int \frac{(\rho - 2)t e^{-\rho^{-1}} dt}{V} \vec{a}_z$$

Integrating by parts yields

$$\vec{B} = [-(\rho - 2)t e^{-\rho^{-1}} + \int (\rho - 2) e^{-\rho^{-1}} dt] \vec{a}_z$$

$$= \underline{\underline{(2 - \rho)(1 + t)e^{-\rho-t} \bar{a}_z}} \text{ Wb/m}^2$$

$$\begin{aligned} \bar{J} &= \nabla \times \bar{H} = \nabla \times \frac{\bar{B}}{\mu_0} = -\frac{1}{\mu_0} \frac{\partial B_z}{\partial \rho} \bar{a}_\phi \\ &= -\frac{1}{\mu_0} (1+t)(-1-2t+\rho)e^{-\rho-t} \bar{a}_\phi \end{aligned}$$

$$\bar{J} = \underline{\underline{\frac{(1+t)(3-\rho)e^{-\rho-t}}{4\pi} \bar{a}_\phi}} \text{ A/m}^2$$

Prob. 9.30 For time factor $e^{j\omega t}$, replace every j by $-j$ and obtain:

$$\bar{B}_s = \nabla \times \bar{A}_s$$

$$\bar{L}_s = -\nabla V_s - j\omega \bar{A}_s$$

$$\nabla \times \bar{A}_s = -j\omega \mu \epsilon V_s$$

$$\nabla^2 V_s + \omega^2 \mu \epsilon V_s = -\rho_s / \epsilon$$

$$\nabla^2 \bar{A}_s + \omega^2 \mu \epsilon \bar{A}_s = -\mu \bar{J}_s$$

Prob. 9.31

(a)

$$z = 4 \angle 30^\circ - 10 \angle 50^\circ = 3.464 + j - 6.427 - j7.66$$

$$= -2.296 - 5.60 = \underline{\underline{6.39 \angle 242.37^\circ}}$$

(b)

$$\frac{1 + j2}{6 - j8 - 7 \angle 15^\circ} = \frac{2.236 \angle 63.43^\circ}{6 - j8 - 7.761 - j1.812} = \frac{2.236 \angle 63.43^\circ}{9.841 \angle 265.57^\circ}$$

$$= \underline{\underline{0.2272 \angle -202.1^\circ}}$$

(c)

$$z = \frac{(5 \angle 53.13^\circ)^2}{12 - j7 - 6 - j10} = \frac{25 \angle 106.26^\circ}{18.028 \angle -70.56^\circ}$$

$$= \underline{\underline{1.387 \angle 176.8^\circ}}$$

(d)

$$\frac{1.897 \angle -100^\circ}{(5.76 \angle 90^\circ)(9.434 \angle -122^\circ)} = \underline{\underline{0.0349 \angle -68^\circ}}$$

Prob. 9.32 (a) $\sin \theta = \cos(\theta - 90^\circ)$

$$E = 4 \cos(\omega t - 3x - 10^\circ) a_y - 5 \cos(\omega t + 3x - 70^\circ) a_z$$

$$= \operatorname{Re} \left[4e^{j(-3x-10^\circ)} e^{j\omega t} a_y - 5e^{j(3x-70^\circ)} e^{j\omega t} a_z \right] = \operatorname{Re} [E_s e^{j\omega t}]$$

$$\underline{\underline{E_s = 4e^{-j(3x+10^\circ)} a_y - 5e^{j(3x-70^\circ)} a_z}}$$

(b) $H = \operatorname{Re} \left[\frac{\sin \theta}{r} e^{j\omega t} e^{-j5r} a_\theta \right] = \operatorname{Re} [H_s e^{j\omega t}]$

$$\underline{\underline{H_s = \frac{\sin \theta}{r} e^{-j5r} a_\theta}}$$

(c) $J = \operatorname{Re} [6e^{-3x} e^{-j2x} e^{-j90^\circ} e^{j\omega t} a_y + \dots] = \operatorname{Re} [J_s e^{j\omega t}]$

$$\underline{\underline{J_s = -j6e^{-(3+j2)x} a_y + 10e^{-(1+j5)x} a_z}}$$

Prob. 9.33 (a) $(4 - j3) = 5e^{-j36.87^\circ}$

$$A_s = 5e^{-j(\beta x + 36.37^\circ)} a_y$$

$$A = \operatorname{Re} [A_s e^{j\omega t}] = \underline{\underline{5 \cos(\omega t - \beta x - 36.37^\circ) a_y}}$$

(b)

$$B = \operatorname{Re} [B_s e^{j\omega t}] = \operatorname{Re} \left[\frac{20}{\rho} e^{j(\omega t - 2z)} a_\rho \right]$$

$$= \underline{\underline{\frac{20}{\rho} \cos(\omega t - 2z) a_\rho}}$$

(c) $1 + j2 = 2.23e^{j63.43^\circ}$

$$C_s = \frac{10}{r^2} (2.236) e^{-j63.43^\circ} e^{-\dots} \sin \theta a_s$$

$$C = \operatorname{Re}[C_s e^{j\omega t}] = \operatorname{Re}\left[\frac{22.36}{r^2} e^{j(\omega t - \phi + 63.43^\circ)} \sin\theta a_\phi\right]$$

$$= \frac{22.36}{r^2} \cos(\omega t - \phi + 63.43^\circ) \sin\theta a_\phi$$

Prob. 9.34

$$A = 4 \cos(\omega t - 90^\circ) a_x + 3 \cos \omega t a_y = \operatorname{Re}\left[4e^{j(\omega t - 90^\circ)} a_x + 3e^{j\omega t} a_y\right] = \operatorname{Re}\left[A_s e^{j\omega t}\right]$$

$$A_s = 4e^{-j90^\circ} a_x + 3a_y = \underline{-j4a_x + 3a_y}$$

$$B_s = 10ze^{j90^\circ} e^{-jz} a_x$$

$$B = \operatorname{Re}\left[B_s e^{j\omega t}\right] = 10z \cos(\omega t - z + 90^\circ) a_x = \underline{-10z \sin(\omega t - z) a_x}$$

Prob. 9.35 We begin with Maxwell's equations:

$$\nabla \cdot D = \rho_v / \epsilon = 0, \quad \nabla \cdot B = 0$$

$$\nabla \times E = -\frac{\partial B}{\partial t}, \quad \nabla \times H = J + \frac{\partial D}{\partial t}$$

We write these in phasor form and in terms of E_s and H_s only.

$$\nabla \cdot E_s = 0 \quad (1)$$

$$\nabla \cdot H_s = 0 \quad (2)$$

$$\nabla \times E_s = -j\omega \mu H_s \quad (3)$$

$$\nabla \times H_s = (\sigma + j\omega \epsilon) E_s \quad (4)$$

Taking the curl of (3),

$$\nabla \times \nabla \times E_s = -j\omega \mu \nabla \times H_s$$

$$\nabla(\nabla \cdot E_s) - \nabla^2 E_s = -j\omega \mu (\sigma + j\omega \epsilon) E_s$$

$$\nabla^2 E_s + (\omega^2 \mu \epsilon - j\omega \mu \sigma) E_s = 0 \quad \longrightarrow \quad \underline{\underline{\nabla^2 E_s + \gamma^2 E_s = 0}}$$

Similarly, by taking the curl of (4),

$$\nabla \times \nabla \times H_s = (\sigma + j\omega \epsilon) \nabla \times E_s$$

$$\nabla(\nabla \cdot H_s) - \nabla^2 H_s = -j\omega\mu(\sigma + j\omega\epsilon)H_s$$

$$\nabla^2 H_s + (\omega^2\mu\epsilon - j\omega\mu\sigma)H_s = 0 \quad \longrightarrow \quad \underline{\underline{\nabla^2 H_s + \gamma^2 H_s = 0}}$$

CHAPTER 10

P. E. 10.1 (a)

$$T = \frac{2\pi}{\omega} = \frac{2\pi}{2 \times 10^8} = \underline{31.42 \text{ ns}},$$

$$\lambda = uT = 3 \times 10^8 \times 31.42 \times 10^{-9} = \underline{9.425 \text{ m}}$$

$$k = \beta = 2\pi / \lambda = \underline{0.677 \text{ rad/m}}$$

$$(b) \quad t_1 = T/8 = \underline{3.927 \text{ ns}}$$

(c)

$$H(t = t_1) = 0.1 \cos\left(2 \times 10^8 \frac{\pi}{8 \times 10^8} - 2x/3\right) a_y = 0.1 \cos(2x/3 - \pi/4) a_y,$$

as sketched below.

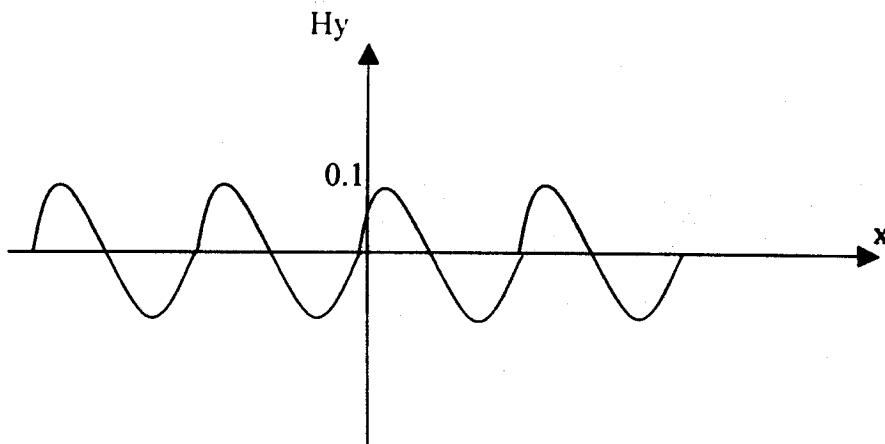
P. E. 10.2 Let $x_o = \sqrt{1 + (\sigma / \omega \epsilon)^2}$, then

$$\alpha = \omega \sqrt{\frac{\mu_o \epsilon_o}{2} \mu_r \epsilon_r (x_o - 1)} = \frac{\omega}{c} \sqrt{\frac{16}{2}} \sqrt{x_o - 1}$$

$$\text{or } \sqrt{x_o - 1} = \frac{\alpha c}{\omega \sqrt{8}} = \frac{1/3 \times 3 \times 10^8}{10^8 \sqrt{8}} = \frac{1}{\sqrt{8}} \quad \longrightarrow \quad x_o = 9/8$$

$$x_o^2 = \frac{81}{64} = 1 + (\sigma / \omega \epsilon)^2 \quad \longrightarrow \quad \frac{\sigma}{\omega \epsilon} = 0.5154$$

$$\tan 2\theta_\eta = 0.5154 \quad \longrightarrow \quad \theta_\eta = 13.63^\circ$$

$$\frac{\beta}{\alpha} = \sqrt{\frac{x_0 + 1}{x_0 - 1}} = \sqrt{17}$$

$$(a) \quad \beta = \alpha \sqrt{17} = \frac{\sqrt{17}}{3} = \underline{1.374 \text{ rad/m}}$$

$$(b) \quad \frac{\sigma}{\omega \epsilon} = \underline{0.5154}$$

$$(c) \quad |\eta| = \frac{\sqrt{\mu / \epsilon}}{\sqrt{x_0}} = \frac{120\pi \sqrt{2/8}}{\sqrt{9/8}} = 177.72$$

$$\eta = \underline{177.72 \angle 13.63^\circ \Omega}$$

$$(d) \quad u = \frac{\omega}{\beta} = \frac{10^8}{1.374} = \underline{7.278 \times 10^7 \text{ m/s}}$$

$$(e) \quad a_H = a_k x a_E \longrightarrow a_x x a_H = a_z \longrightarrow a_H = a_y$$

$$H = \frac{0.5}{177.5} e^{-z/3} \sin(10^8 t - \beta z - 13.63^\circ) a_y = \underline{2.817 e^{-z/3} \sin(10^8 t - \beta z - 13.63^\circ) a_y \text{ mA/m}}$$

P. E. 10.3 (a) Along -z direction

$$(b) \quad \lambda = \frac{2\pi}{\beta} = 2\pi / 2 = \underline{3.142 \text{ m}}$$

$$f = \frac{\omega}{2\pi} = \frac{10^8}{2\pi} = \underline{15.92 \text{ MHz}}$$

$$\beta = \omega \sqrt{\mu \epsilon} = \omega \sqrt{\mu_o \epsilon_o} \sqrt{\mu_r \epsilon_r} = \frac{\omega}{c} \sqrt{(I) \epsilon_r}$$

$$\text{or } \sqrt{\epsilon_r} = \beta c / \omega = \frac{3 \times 10^8 \times 2}{2 \times 10^8} = 6 \longrightarrow \underline{\epsilon_r = 3.6}$$

$$(c) \quad \theta_n = 0, |\eta| = \sqrt{\mu / \epsilon} = \sqrt{\mu_o / \epsilon_o} \sqrt{I / \epsilon_r} = \frac{120\pi}{6} = 20\pi$$

$$a_k = a_E x a_H \longrightarrow -a_z = a_x x a_H \longrightarrow a_H = a_x$$

$$H = \frac{50}{20\pi} \sin(\omega t + \beta z) a_x = \underline{\underline{795.8 \sin(10^8 t + 2z) a_x}} \text{ mA/m}$$

P. E. 10.4 (a)

$$\frac{\sigma}{\omega \epsilon} = \frac{10^{-2}}{10^9 \pi \times 4 \times \frac{10^{-9}}{36\pi}} = 0.09$$

$$\alpha \cong \omega \sqrt{\frac{\mu \epsilon}{2} \left[1 + \frac{1}{2} \left(\frac{\sigma}{\omega \epsilon} \right)^2 - 1 \right]} = \frac{\omega}{2c} \sqrt{\mu_r \epsilon_r} \frac{\sigma}{\omega \epsilon} = \frac{10^9 \pi}{2 \times 3 \times 10^8} (2)(0.09) = 0.9425$$

$$\beta \cong \omega \sqrt{\frac{\mu \epsilon}{2} \left[1 + \frac{1}{2} \left(\frac{\sigma}{\omega \epsilon} \right)^2 + 1 \right]} = \frac{10^9 \pi}{3 \times 10^8} \sqrt{2[2 + 0.5(0.09)^2]} = 20.965$$

$$E = 30e^{-0.9425y} \cos(10^9 \pi t - 20.96y + \pi/4) a_z$$

At $t = 2\text{ns}$, $y = 1\text{m}$,

$$E = 30e^{-0.9425} \cos(2\pi - 20.96 + \pi/4) a_z = \underline{\underline{2.787 a_z}} \text{ V/m}$$

$$(b) \beta y = 10^\circ = \frac{10\pi}{180} \text{ rad}$$

or

$$y = \frac{\pi l}{18 \beta} = \frac{\pi}{18 \times 20.905} = \underline{\underline{8.325 \text{ mm}}}$$

$$(c) 30(0.6) = 30 e^{-\alpha y}$$

$$y = \frac{l}{\alpha} \ln(1/0.6) = \frac{l}{0.9425} \ln \frac{1}{0.6} = \underline{\underline{542 \text{ mm}}}$$

(d)

$$|\eta| \cong \frac{\sqrt{\mu/\epsilon}}{\left[1 + \frac{1}{4} (0.09)^2 \right]} = \frac{60\pi}{1.002} = 188.11$$

$$2\theta_{\dots} = \tan^{-1} 0.09 \longrightarrow \theta_{\dots} = 2.571^\circ$$

$$a_H = a_k x a_E = a_y x a_z = a_x$$

$$H = \frac{30}{188.11} e^{-0.9425y} \cos(10^9 \pi t - 20.96y + \pi/4 - 2.571^\circ) a_x$$

At $y = 2\text{m}$, $t = 5\text{ns}$,

$$H = (0.1595)(0.1518) \cos(-4.5165\text{rad}) a_x = \underline{\underline{-4.71 a_x}} \text{ mA/m}$$

P. E. 10.5

$$I_s = \int_0^w \int_0^\infty J_{xs} dy dz = J_{xs}(0) \int_0^w dy \int_0^\infty e^{-z(1+j)\delta} dz = \frac{J_{xs}(0) w \delta}{1+j}$$

$$\underline{\underline{|I_s| = \frac{J_{xs}(0) w \delta}{\sqrt{2}}}}$$

P. E. 10.6 (a)

$$\frac{R_{ac}}{R_{dc}} = \frac{a}{2\delta} = \frac{a}{2} \sqrt{\pi f \mu \sigma} = \frac{1.3 \times 10^{-3}}{2} \sqrt{\pi \times 10^7 \times 4\pi \times 10^{-7} \times 3.5 \times 10^7} = \underline{\underline{24.16}}$$

(b)

$$\frac{R_{ac}}{R_{dc}} = \frac{1.3 \times 10^{-3}}{2} \sqrt{\pi \times 2 \times 10^9 \times 4\pi \times 10^{-7} \times 3.5 \times 10^7} = \underline{\underline{1080.54}}$$

P. E. 10.7

$$\mathcal{P}_{\text{ave}} = \frac{1}{2} \eta H_o^2 a_x$$

(a) Let $f(x,z) = x + z - 1 = 0$

$$a_n = \frac{\nabla f}{|\nabla f|} = \frac{a_x + a_z}{\sqrt{2}}, \quad dS = dS a_n$$

$$P_t = \int \mathcal{P} \cdot dS = \mathcal{P} \cdot \mathbf{S} a_n = \frac{1}{2} \eta H_o^2 a_x \cdot \frac{a_x + a_z}{\sqrt{2}}$$

$$= \frac{1}{2\sqrt{2}} (120\pi)(0.2)^2 (0.1)^2 = \underline{\underline{53.31 \text{ mW}}}$$

$$(d) \, dS = dydz a_x, \quad P_t = \int \mathcal{P} \cdot dS = \frac{1}{2} \eta H_o^2 S$$

$$P_t = \frac{1}{2} (120\pi)(0.2)^2 \pi (0.05)^2 = \underline{\underline{59.22 \text{ mW}}}$$

$$\text{P. E. 10.8} \quad \eta_1 = \eta_o = 120\pi, \eta_2 = \sqrt{\frac{\eta}{\epsilon}} = \frac{\eta_o}{2}$$

$$\tau = \frac{2\eta_2}{\eta_2 + \eta_1} = 2/3, \Gamma = \frac{\eta_2 - \eta_1}{\eta_2 + \eta_1} = -1/3$$

$$E_{ro} = \Gamma E_{io} = -\frac{10}{3}$$

$$\underline{\underline{E_{rs} = -\frac{10}{3} e^{-\beta_1 z} a_x \text{ V/m}}}$$

where $\beta_1 = \omega / c = 100\pi / 3$.

$$E_{io} = \tau E_{io} = \frac{20}{3}$$

$$\underline{\underline{E_{is} = \frac{20}{3} e^{-\beta_2 z} a_x \text{ V/m}}}$$

where $\beta_2 = \omega \sqrt{\epsilon_r} / c = 2\beta_1 = 200\pi / 3$.

P. E. 10.9

$$\alpha_1 = 0, \beta_1 = \frac{\omega}{c} \sqrt{\mu_r \epsilon_r} = \frac{2\omega}{c} = 5 \longrightarrow \omega = 5c/2 = 7.5 \times 10^8$$

$$\frac{\sigma_2}{\omega \epsilon_2} = \frac{0.1}{7.5 \times 10^8 \times 4 \times \frac{10^{-9}}{36\pi}} = 1.2\pi$$

$$\alpha_2 = \frac{\omega}{c} \sqrt{\frac{4}{2} [\sqrt{1 + 1.44\pi^2} - 1]} = 6.021$$

$$\beta_2 = \frac{\omega}{c} \sqrt{\frac{4}{2} [\sqrt{1 + 1.44\pi^2} + 1]} = \underline{\underline{7.826}}$$

$$|\eta_2| = \frac{60\pi}{\sqrt{1 + 1.44\pi^2}} = 95.445, \eta_1 = 120\pi\sqrt{\epsilon_{r1}} = 754$$

$$\tan 2\theta_{\eta_2} = 1.2\pi \longrightarrow \theta_{\eta_2} = 37.57^\circ$$

$$\eta_2 = 95.445 \angle 37.57^\circ$$

(a)

$$\Gamma = \frac{\eta_2 - \eta_1}{\eta_2 + \eta_1} = \frac{95.445 \angle 37.57^\circ - 754}{95.445 \angle 37.57^\circ + 754} = \underline{\underline{0.8186 \angle 171.08^\circ}}$$

$$\tau = 1 + \Gamma = \underline{\underline{0.2295 \angle 33.56^\circ}}$$

$$s = \frac{1 + |\Gamma|}{1 - |\Gamma|} = \frac{1 + 0.8186}{1 - 0.8186} = \underline{\underline{10.025}}$$

(b) $E_t = 50 \sin(\omega t - 5x) a_y = \text{Im}(E_{ts} e^{j\omega t})$, where $E_{ts} = 50 e^{-j5x} a_y$.

$$E_{ro} = \Gamma E_{to} = 0.8186 e^{j171.08^\circ} (50) = 40.93 e^{j171.08^\circ}$$

$$E_{rs} = 40.93 e^{j5x + j171.08^\circ} a_y$$

$$E_r = \text{Im}(E_{rs} e^{j\omega t}) = \underline{\underline{40.93 \sin(\omega t + 5x + 171.1^\circ) a_y}} \text{ V/m}$$

$$a_H = a_k x a_E = -a_x x a_y = -a_z$$

$$H_r = -\frac{40.93}{754} \sin(\omega t + 5x + 171.1^\circ) a_z = \underline{\underline{-0.0543 \sin(\omega t + 5x + 171.1^\circ) a_z}} \text{ A/m}$$

(c)

$$E_{to} = \tau E_{io} = 0.229 e^{j33.56^\circ} (50) = 11.475 e^{j33.56^\circ}$$

$$E_{ts} = 11.475 e^{-j\beta_1 x + j33.56^\circ} e^{-\alpha_1 x} a_y$$

$$E_t = \text{Im}(E_{ts} e^{j\omega t}) = \underline{\underline{11.475 e^{-6.021x} \sin(\omega t - 7.826x + 33.56^\circ) a_y}} \text{ V/m}$$

$$a_H = a_k x a_t = a_x x a_y = a_z$$

$$H_t = \frac{11.495}{95.445} e^{-6.021x} \sin(\omega t - 7.826x + 33.56^\circ - 37.57^\circ) a_z$$

$$= \underline{\underline{0.1202 e^{-6.021x} \sin(\omega t - 7.826x - 4.01^\circ) a_z}} \quad \text{A/m}$$

(d)

$$\mathcal{P}_{\text{ave}} = \frac{E_w^2}{2\eta_1} a_x + \frac{E_{ro}^2}{2\eta_1} (-a_x) = \frac{1}{2(240\pi)} [50^2 a_x - 40.93^2 a_x] = \underline{\underline{0.5469 a_x}} \quad \text{W/m}^2$$

$$\mathcal{P}_{\text{ave}} = \frac{E_w^2}{2|\eta_2|} e^{-2\alpha_2 x} \cos\theta_{\eta_2} a_x = \frac{(11.475)^2}{2(95.445)} \cos 37.57^\circ e^{-2(6.021)x} a_x = \underline{\underline{0.5469 e^{-12.04} a_x}} \quad \text{W/m}^2$$

P. E. 10.10 (a)

$$k = -2a_y + 4a_z \longrightarrow k = \sqrt{2^2 + 4^2} = \sqrt{20}$$

$$\omega = kc = 3 \times 10^8 \sqrt{20} = \underline{\underline{1.342 \times 10^9}} \text{ rad/s,}$$

$$\lambda = 2\pi k = \underline{\underline{28.1\text{m}}}$$

$$(b) H = \frac{a_k \times E}{\eta_o} = \frac{(-2a_y + 4a_z)}{\sqrt{20}(120\pi)} \times (10a_y + 5a_z) \cos(\omega t - k \cdot r)$$

$$= \underline{\underline{-29.66 \cos(1.342 \times 10^9 t + 2y - 4z) a_x}} \quad \text{mA/m}$$

$$(c) \mathcal{P}_{\text{ave}} = \frac{|E_o|^2}{2\eta_o} a_k = \frac{125}{2(120\pi)} \frac{(-2a_y + 4a_z)}{\sqrt{20}} = \underline{\underline{-74.15 a_y + 148.9 a_z}} \quad \text{W/m}^2$$

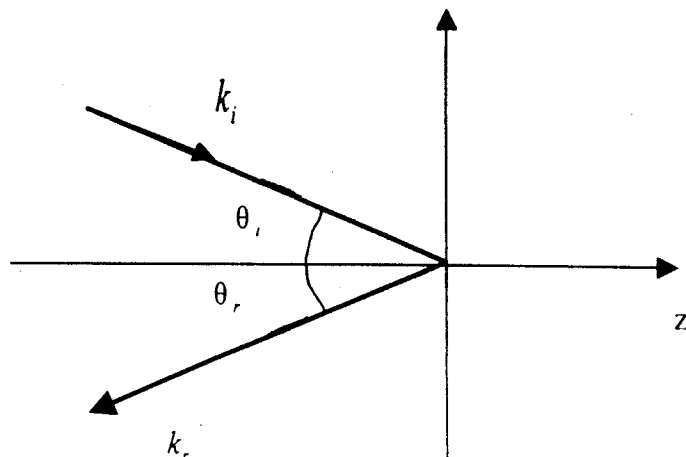
P. E. 10.11 (a)

$$\tan \theta_t = \frac{k_{iy}}{k_{iz}} = \frac{2}{4} \longrightarrow \underline{\underline{\theta_t = 26.56 = \theta_r}}$$

$$\sin \theta_t = \sqrt{\frac{\mu_1 \epsilon_1}{\mu_2 \epsilon_2}} \sin \theta_r = \frac{1}{2} \sin 26.56^\circ \longrightarrow \underline{\underline{\theta_t = 12.92^\circ}}$$

(b) $\eta_1 = \eta_o, \eta_2 = \eta_o / 2$, \mathbf{E} is parallel to the plane of incidence. Since $\mu_1 = \mu_2 = \mu_o$, we may use the result of Prob. 10.42, i.e.

$$\Gamma_{\parallel} = \frac{\tan(\theta_t - \theta_r)}{\tan(\theta_t + \theta_r)} = \frac{\tan(-13.64^\circ)}{\tan(39.48^\circ)} = \underline{\underline{-0.2946}}$$

$$\tau_{\parallel} = \frac{2 \cos 26.56^\circ \sin 12.92^\circ}{\sin 39.48^\circ \cos(-13.64^\circ)} = \underline{\underline{0.6474}}$$

(c) $k_r = -\beta_1 \sin \theta_r \mathbf{a}_y - \beta_1 \cos \theta_r \mathbf{a}_z$. Once k_r is known, E_r is chosen such that

$k_r \cdot E_r = 0$ or $\nabla \cdot E_r = 0$. Let

$$E_r = \pm E_{or} (-\cos \theta_r \mathbf{a}_y + \sin \theta_r \mathbf{a}_z) \cos(\omega t + \beta_1 \sin \theta_r y + \beta_1 \cos \theta_r z)$$

Only the positive sign will satisfy the boundary conditions. It is evident that

$$E_t = E_{ot} (\cos \theta_r \mathbf{a}_y + \sin \theta_r \mathbf{a}_z) \cos(\omega t + 2y - 4z)$$

Since $\theta_r = \theta_t$,

$$E_{or} \cos \theta_r = \Gamma_{\parallel} E_{ot} \cos \theta_t = 10 \Gamma_{\parallel} = -2.946$$

$$E_{or} \sin \theta_r = \Gamma_{\parallel} E_{ot} \sin \theta_t = 5 \Gamma_{\parallel} = -1.473$$

$$\beta_1 \sin \theta_r = 2, \beta_1 \cos \theta_r = 4$$

i.e.

$$E_r = -(2.946 \mathbf{a}_y - 1.473 \mathbf{a}_z) \cos(\omega t + 2y + 4z)$$

$$E_t = E_i + E_r = \underline{\underline{(10 \mathbf{a}_y + 5 \mathbf{a}_z) \cos(\omega t + 2y - 4z) + (-2.946 \mathbf{a}_y + 1.473 \mathbf{a}_z) \cos(\omega t + 2y + 4z)}}$$

V/m

(d) $k_t = -\beta_2 \sin\theta_t a_y + \beta_2 \cos\theta_t a_z$. Since $k_r \cdot E_r = 0$, let

$$E_t = E_{ot} (\cos\theta_t a_y + \sin\theta_t a_z) \cos(\omega t + \beta_2 y \sin\theta_t - \beta_2 z \cos\theta_t)$$

$$\beta_2 = \omega \sqrt{\mu_2 \epsilon_2} = \beta_1 \sqrt{\epsilon_{r2}} = 2\sqrt{20}$$

$$\sin\theta_t = \frac{1}{2} \sin\theta_1 = \frac{1}{2\sqrt{5}}, \quad \cos\theta_t = \frac{\sqrt{9}}{\sqrt{20}}$$

$$\beta_2 \cos\theta_t = 2\sqrt{20} \sqrt{\frac{19}{20}} = 8.718$$

$$E_{ot} \cos\theta_t = \tau_{12} E_{o1} \cos\theta_1 = 0.6474 \sqrt{125} \sqrt{\frac{19}{20}} = 7.055$$

$$E_{ot} \sin\theta_t = \tau_{12} E_{o1} \sin\theta_1 = 0.6474 \sqrt{125} \sqrt{\frac{1}{20}} = 1.6185$$

Hence

$$E_2 = E_t = \underline{\underline{(7.055a_y + 1.6185a_z) \cos(\omega t + 2y - 8.718z) \text{ V/m}}}$$

$$(d) \tan\theta_{B11} = \sqrt{\frac{\epsilon_2}{\epsilon_1}} = 2 \longrightarrow \underline{\underline{\theta_{B11} = 63.43^\circ}}$$

Prob. 10.1 (a) Wave propagates along $+a_x$.

(b)

$$T = \frac{2\pi}{\omega} = \frac{2\pi}{2\pi \times 10^6} = \underline{\underline{1\mu s}}$$

$$\lambda = \frac{2\pi}{\beta} = \frac{2\pi}{6} = \underline{\underline{1.047\text{m}}}$$

$$u = \frac{\omega}{\beta} = \frac{2\pi \times 10^6}{6} = \underline{\underline{1.047 \times 10^6 \text{ m/s}}}$$

(c) At $t=0$, $E_z = 25 \sin(-6x) = -25 \sin 6x$

$$\text{At } t=T/8, E_z = 25 \sin\left(\frac{2\pi}{T} \frac{T}{8} - 6x\right) = 25 \sin\left(\frac{\pi}{4} - 6x\right)$$

$$\text{At } t=T/4, E_z = 25 \sin\left(\frac{2\pi T}{T} \frac{T}{4} - 6x\right) = 25 \sin(-6x + 90^\circ) = 25 \cos 6x$$

$$\text{At } t=T/2, E_z = 25 \sin\left(\frac{2\pi T}{T} \frac{T}{2} - 6x\right) = 25 \sin(-6x + \pi) = 25 \sin 6x$$

These are sketched below.

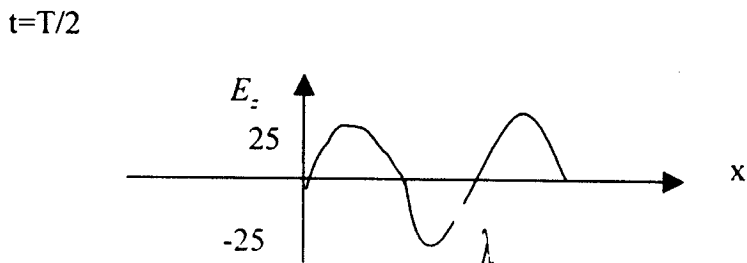
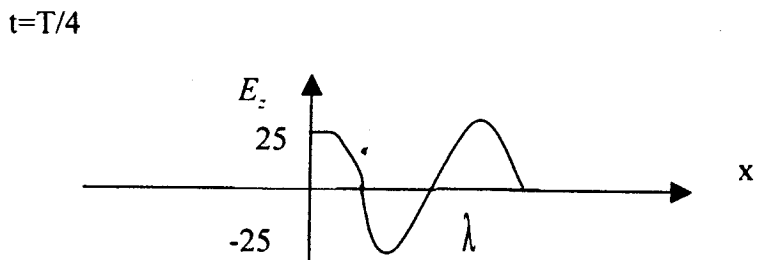
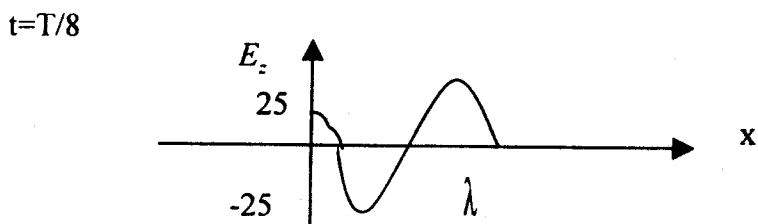
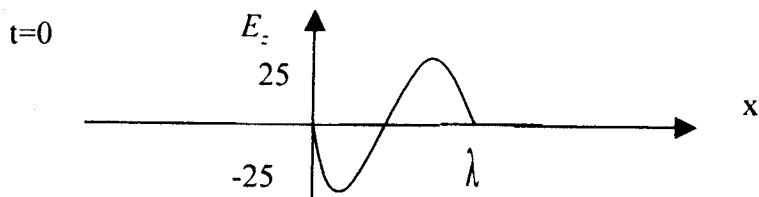

Prob. 10.2 If

$\gamma^2 = j\omega\mu(\sigma + j\omega\varepsilon) = -\omega^2\mu\varepsilon + j\omega\mu\sigma$ and $\gamma = \alpha + j\beta$, then

$$|\gamma^2| = \sqrt{(\alpha^2 - \beta^2)^2 + 4\alpha^2\beta^2} = \sqrt{(\alpha^2 + \beta^2)^2} = \alpha^2 + \beta^2$$

i.e.

$$\alpha^2 + \beta^2 = \omega\mu\sqrt{(\sigma^2 + \omega^2\varepsilon^2)} \quad (1)$$

$$\operatorname{Re}(\gamma^2) = \alpha^2 - \beta^2 = -\omega^2\mu\varepsilon$$

$$\beta^2 - \alpha^2 = \omega^2\mu\varepsilon \quad (2)$$

Subtracting and adding (1) and (2) lead respectively to

$$\alpha = \omega\sqrt{\frac{\mu\varepsilon}{2}\left[\sqrt{1 + \left(\frac{\sigma}{\omega\varepsilon}\right)^2} - 1\right]}$$

$$\beta = \omega\sqrt{\frac{\mu\varepsilon}{2}\left[\sqrt{1 + \left(\frac{\sigma}{\omega\varepsilon}\right)^2} + 1\right]}$$

(b) From eq. (10.25), $E_s(z) = E_o e^{-\gamma z} a_x$.

$$\nabla_x E = -j\omega\mu H_s \quad \longrightarrow \quad H_s = \frac{j}{\omega\mu} \nabla_x E_s = \frac{j}{\omega\mu} (-\gamma E_o e^{-\gamma z} a_y)$$

But $H_s(z) = H_o e^{-\gamma z} a_y$, hence $H_o = \frac{E_o}{\eta} = -\frac{j\gamma}{\omega\mu} E_o$

$$\eta = \frac{j\omega\mu}{\gamma}$$

(c) From (b),

$$\eta = \frac{j\omega\mu}{\sqrt{j\omega\mu(\sigma + j\omega\varepsilon)}} = \sqrt{\frac{j\omega\mu}{\sigma + j\omega\varepsilon}} = \frac{\sqrt{\mu/\varepsilon}}{\sqrt{1 - j\frac{\sigma}{\omega\varepsilon}}}$$

$$|\eta| = \frac{\sqrt{\mu/\epsilon}}{\sqrt{1 + \left(\frac{\sigma}{\omega\epsilon}\right)^2}}, \tan 2\theta_\eta = \left(\frac{\omega\epsilon}{\sigma}\right)^{-1} = \frac{\sigma}{\omega\epsilon}$$

Prob. 10.3 (a)

$$\frac{\sigma}{\omega\epsilon} = \frac{8 \times 10^{-2}}{50 \times 10^6 \times 3.6 \times \frac{10^{-9}}{36\pi}} = 8$$

$$\alpha = \omega \sqrt{\frac{\mu\epsilon}{2} \left[\sqrt{1 + \left(\frac{\sigma}{\omega\epsilon}\right)^2} - 1 \right]} = \frac{2\pi \times 50 \times 10^6}{3 \times 10^8} \sqrt{\frac{2.1 \times 3.6}{2} [\sqrt{65} - 1]} = 5.41$$

$$\beta = \omega \sqrt{\frac{\mu\epsilon}{2} \left[\sqrt{1 + \left(\frac{\sigma}{\omega\epsilon}\right)^2} + 1 \right]} = 6.129$$

$$\gamma = \alpha + j\beta = \underline{\underline{5.41 + j6.129}} \text{ /m}$$

$$(b) \quad \lambda = \frac{2\pi}{\beta} = \frac{2\pi}{6.129} = \underline{\underline{1.025}} \text{ m}$$

$$(c) \quad u = \frac{\omega}{\beta} = \frac{2\pi \times 50 \times 10^6}{6.129} = \underline{\underline{5.125 \times 10^7}} \text{ m/s}$$

$$(d) \quad |\eta| = \frac{\sqrt{\frac{\mu}{\epsilon}}}{\sqrt{1 + \left(\frac{\sigma}{\omega\epsilon}\right)^2}} = \frac{120\pi \sqrt{\frac{2.1}{3.6}}}{\sqrt{65}} = 101.4$$

$$\tan 2\theta_\eta = \frac{\sigma}{\omega\epsilon} = 8 \longrightarrow \theta_\eta = 41.44^\circ$$

$$\eta = \underline{\underline{101.41 \angle 41.44^\circ \Omega}}$$

$$(e) \quad H_x = a_x \times \frac{E_y}{\eta} = a_x \times \frac{6}{\eta} e^{-\gamma z} a_z = -\frac{6}{\eta} e^{-\gamma z} a_x = \underline{\underline{-59.16 e^{-141.44z} e^{-\gamma z} a_x}} \text{ mA/m}$$

Prob. 10.4 (a) Let $u = \frac{\sigma}{\omega \epsilon} = \text{loss tangent}$

$$\beta = \omega \sqrt{\frac{\mu \epsilon}{2} [\sqrt{1+u^2} + 1]}$$

$$10 = \frac{\omega}{c} \sqrt{\frac{5 \times 2}{2} [\sqrt{1+u^2} + 1]} = \frac{2\pi \times 5 \times 10^6 \sqrt{5}}{3 \times 10^8} \sqrt{[\sqrt{1+u^2} + 1]}$$

which leads to

$$u = \frac{\sigma}{\omega \epsilon} = \underline{1823}$$

$$(b) \sigma = \omega \epsilon u = 2\pi \times 5 \times 10^6 \times 1823 \times \frac{10^{-9}}{36\pi} = \underline{1.013 \text{ S/m}}$$

$$(c) \epsilon_c = \epsilon' - j\epsilon'' = \epsilon - j\frac{\sigma}{\omega} = 2\pi \times \frac{10^{-9}}{36\pi} - j\frac{1.023}{2\pi \times 5 \times 10^6} = \underline{\underline{1.768 \times 10^{-11} - j3.224 \times 10^{-8} \text{ F/m}}}$$

$$(d) \frac{\alpha}{\beta} = \frac{\sqrt{\sqrt{1+u^2} - 1}}{\sqrt{\sqrt{1+u^2} + 1}} = \sqrt{\frac{1822}{1824}}$$

$$\alpha = \underline{9.995 \text{ Np/m}}$$

$$(e) |\eta| = \frac{\sqrt{\frac{\mu}{\epsilon}}}{\sqrt[3]{1+u^2}} = \frac{120\pi \sqrt{\frac{5}{2}}}{\sqrt[3]{1+1823^2}} = 13.96$$

$$\tan 2\theta_\eta = u = 1823 \longrightarrow \theta_\eta = 44.98^\circ$$

$$\eta = \underline{\underline{13.96 \angle 44.98^\circ \Omega}}$$

Prob. 10.5 (a) $\frac{\sigma}{\omega \epsilon} = \tan 2\theta_\eta = \tan 60^\circ = \underline{1.732}$

$$(b) |\eta| = 240 = \frac{120\pi}{\sqrt[3]{1+3}} = \frac{120\pi}{\sqrt{2\epsilon_r}} \longrightarrow \epsilon_r = \frac{\pi^2}{8} = \underline{1.234}$$

$$(c) \quad \epsilon_c = \epsilon \left(1 - j \frac{\sigma}{\omega \epsilon}\right) = 1.234x \frac{10^{-9}}{36\pi} (1 - j1.732) = \underline{\underline{(1.091 - j1.89)x10^{-11} \text{ F/m}}}$$

(d)

$$\alpha = \frac{\omega}{c} \sqrt{\frac{\mu_r \epsilon_r}{2} \left[\sqrt{1 + \left(\frac{\sigma}{\omega \epsilon}\right)^2} - 1 \right]} = \frac{2\pi x 10^6}{3x10^8} \sqrt{\frac{1}{2} \frac{\pi^2}{8} [\sqrt{1+3} - 1]} = \underline{\underline{0.0164 \text{ Np/m}}}$$

Prob. 10.6 (a) $|E| = E_0 e^{-\alpha z}$

$$E_0 e^{-\alpha(1)} = (1 - 0.18)E_0 \longrightarrow e^{-\alpha} = 0.82$$

$$\alpha = \ln \frac{1}{0.82} = 0.1984$$

$$\theta_n = 24^\circ \longrightarrow \tan 2\theta_n = \frac{\sigma}{\omega \epsilon} = 1.111$$

$$\frac{\alpha}{\beta} = \frac{\sqrt{\sqrt{1 + \left(\frac{\sigma}{\omega \epsilon}\right)^2} - 1}}{\sqrt{\sqrt{1 + \left(\frac{\sigma}{\omega \epsilon}\right)^2} + 1}} = \frac{\sqrt{\sqrt{2.233} - 1}}{\sqrt{\sqrt{2.233} + 1}} = 2.247, \quad \beta = 0.4458$$

$$\gamma = \alpha + j\beta = \underline{\underline{0.1984 + j0.4458 \text{ /m}}}$$

$$(b) \quad \lambda = \frac{2\pi}{\beta} = 2\pi / 0.4458 = \underline{\underline{14.09 \text{ m}}}$$

$$(c) \quad \delta = 1/\alpha = \underline{\underline{5.04 \text{ m}}}$$

(d) Since

$$\alpha = \omega \sqrt{\frac{\mu \epsilon}{2} \left[\sqrt{1 + \left(\frac{\sigma}{\omega \epsilon}\right)^2} - 1 \right]} = \frac{\omega}{c} \sqrt{\frac{\mu_r \epsilon_r}{2}} \sqrt{0.494}, \quad \mu_r = 1$$

$$\sqrt{\frac{\epsilon_r}{2}} = \frac{\alpha c}{\omega \sqrt{0.494}} = \frac{0.1984x3x10^8}{2\pi x 10^6 \sqrt{0.494}} = 1.348 \longrightarrow \epsilon_r = 3.633$$

Since $\frac{\sigma}{\omega \epsilon} = 1.111$

$$\sigma = \omega \epsilon_0 \epsilon_r \times 1.111 = 2\pi \times 10^7 \times \frac{10^{-9}}{36\pi} \times 3.633 \times 1.111 = \underline{\underline{2.24 \times 10^{-3} \text{ S/m}}}$$

Prob. 10.7

$$\frac{\sigma}{\omega \epsilon} = \frac{4}{2\pi \times 10^5 \times 81 \times 10^{-9} / 36\pi} = \frac{80,000}{9} \gg 1$$

$$\alpha = \beta = \sqrt{\frac{\omega \mu \sigma}{2}} = \sqrt{\frac{2\pi \times 10^5}{2} \times 4\pi \times 10^{-7} \times 4} = 0.4\pi$$

(a) $u = \omega / \beta = \frac{2\pi \times 10^5}{0.4\pi} = \underline{\underline{5 \times 10^5 \text{ m/s}}}$

(b) $\lambda = 2\pi / \beta = \frac{2\pi}{0.4\pi} = \underline{\underline{5 \text{ m}}}$

(c) $\delta = 1/\alpha = \frac{1}{0.4\pi} = \underline{\underline{0.796 \text{ m}}}$

(d) $\eta = |\eta| \angle \theta_\eta, \theta_\eta = 45^\circ$

$$|\eta| = \frac{\sqrt{\frac{\mu}{\epsilon}}}{\sqrt{1 + \left(\frac{\sigma}{\omega \epsilon}\right)^2}} \cong \sqrt{\frac{\mu}{\epsilon}} \frac{\omega \epsilon}{\sigma} = \sqrt{\frac{4\pi \times 10^{-7} \times 2\pi \times 10^8}{4}} = 14.05$$

$$\eta = \underline{\underline{14.05 \angle 45^\circ \quad \Omega}}$$

Prob. 10.8 (a)

$$T = 1/f = 2\pi / \omega = \frac{2\pi}{\pi \times 10^8} = \underline{\underline{20 \text{ ns}}}$$

(b) Let $x = \sqrt{1 + \left(\frac{\sigma}{\omega \epsilon}\right)^2}$

$$\frac{\alpha}{\beta} = \left(\frac{x-1}{x+1}\right)^{1/2}$$

$$\text{But } \alpha = \frac{\omega}{c} \sqrt{\frac{\mu_r \epsilon_r}{2}} \sqrt{x-1}$$

$$\sqrt{x-1} = \frac{\alpha c}{\omega \sqrt{\frac{\mu_r \epsilon_r}{2}}} = \frac{0.1 \times 3 \times 10^8}{\pi \times 10^8 \sqrt{2}} = 0.06752 \longrightarrow x = 1.0046$$

$$\beta = \left(\frac{x+1}{x-1} \right)^{1/2} \alpha = \left(\frac{2.0046}{0.0046} \right)^{1/2} 0.1 = 2.088$$

$$\lambda = 2\pi / \beta = \frac{2\pi}{2.088} = 3 \text{ m}$$

$$(c) |\eta| = \frac{\sqrt{\mu/\epsilon}}{\sqrt{x}} = \frac{377}{2\sqrt{1.0046}} = 188.1$$

$$x = \sqrt{1 + \left(\frac{\sigma}{\omega \epsilon} \right)^2} = 1.0046$$

$$\frac{\sigma}{\omega \epsilon} = 0.096 = \tan \theta_\eta \longrightarrow \theta_\eta = 2.74^\circ$$

$$\eta = 188.1 \angle 2.74^\circ \quad \Omega$$

$$E_o = \eta H_o = 12 \times 188.1 = 2256.84$$

$$a_E \times a_H = a_k \longrightarrow a_E \times a_x = a_y \longrightarrow a_E = a_z$$

$$E = \underline{2.256 e^{-0.1y} \sin(\pi \times 10^8 t - 2.088y + 2.74^\circ)} a_z \quad \text{kV/m}$$

(e) The phase difference is 2.74°.

Prob. 10.9 (a) $\gamma = \alpha + j\beta = \underline{0.05 + j2} \text{ /m}$

(b) $\lambda = 2\pi / \beta = \pi = \underline{3.142} \text{ m}$

(c) $u = \omega / \beta = \frac{2 \times 10}{2} = \underline{10^8} \text{ m/s}$

$$(d) \delta = 1/\alpha = \frac{1}{0.05} = \underline{20} \text{ m}$$

$$\text{Prob. 10.10 (a) } \beta = \omega / c = \frac{2\pi \times 10^6}{3 \times 10^8} = \underline{0.02094} \text{ rad/m,}$$

$$\lambda = 2\pi / \beta = \underline{300} \text{ m}$$

$$(b) \text{ When } z = 0, \quad E_y = 10 \cos \omega t$$

$$z = \lambda / 4, \quad E_y = 10 \cos\left(\omega t - \frac{2\pi}{\lambda} \frac{\lambda}{4}\right) = 10 \sin \omega t$$

$$z = \lambda / 2, \quad E_y = 10 \cos(\omega t - \pi) = -10 \cos \omega t$$

Thus E is sketched below.

$z = 0$

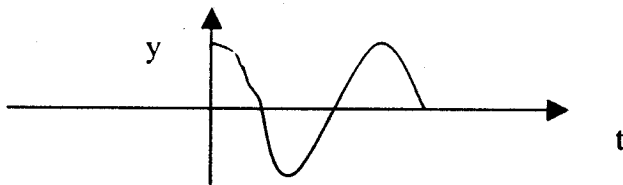

$z = \lambda / 4$

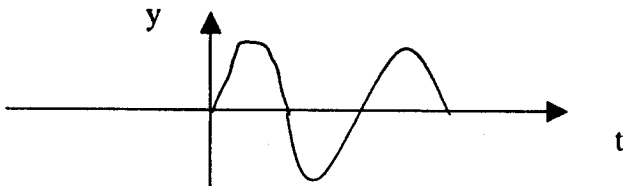

$z = \lambda / 2$

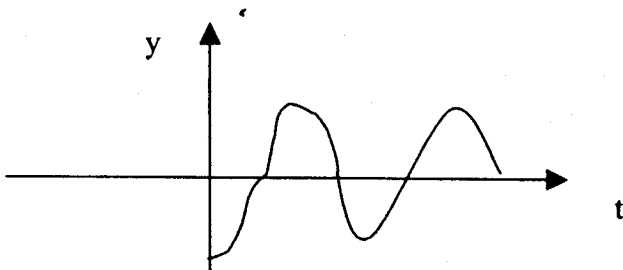

(c)

$$H = \frac{1}{120\pi} \cos(2\pi \times 10^6 t - 2\pi z / 300) \mathbf{a}_x = \underline{26.53 \cos(2\pi \times 10^6 t - 0.02094) \mathbf{a}_x} \text{ A/m}$$

Prob. 10.11 (a) Along -x direction.

$$(b) \beta = 6, \quad \omega = 2 \times 10^8.$$

$$\beta = \omega \sqrt{\mu \epsilon} = \frac{\omega}{c} \sqrt{\mu_r \epsilon_r}$$

$$\sqrt{\epsilon_r} = \beta c / \omega = \frac{6 \times 3 \times 10^8}{2 \times 10^8} = 9 \quad \longrightarrow \quad \epsilon_r = 81$$

$$\epsilon = \epsilon_0 \epsilon_r = \frac{10^{-9}}{36\pi} \times 81 = \underline{\underline{7.162 \times 10^{-10} \text{ F/m}}}$$

$$(c) \eta = \sqrt{\mu / \epsilon} = \sqrt{\mu_0 / \epsilon_0} \sqrt{\mu_r / \epsilon_r} = \frac{120\pi}{9}$$

$$E_0 = H_0 \eta = 25 \times 10^{-3} \times 377 / 9 = 1.047$$

$$a_E \cdot x a_H = a_k \quad \longrightarrow \quad a_E \cdot x a_y = -a_x \quad \longrightarrow \quad a_E = a_z$$

$$E = \underline{\underline{1.047 \sin(2 \times 10^8 t + 6x) a_z}} \quad \text{V/m}$$

$$\text{Prob. 10.12} \quad \beta = 4 \quad \longrightarrow \quad \lambda = 2\pi / \beta = \underline{\underline{1.571 \text{ m}}}$$

$$\text{Also, } \beta = \omega / u = \omega \sqrt{\mu \epsilon} = \frac{\omega}{c} \sqrt{\mu_r \epsilon_r}$$

$$\omega = \frac{\beta c}{\sqrt{\mu_r \epsilon_r}} = \frac{4 \times 3 \times 10^8}{\sqrt{4}} = \underline{\underline{6 \times 10^8 \text{ rad/s}}}$$

$$J_d = \nabla \times H = \begin{vmatrix} \frac{\partial}{\partial x} & \frac{\partial}{\partial y} & \frac{\partial}{\partial z} \\ H_x(z) & 0 & 0 \end{vmatrix} = \frac{\partial H_x}{\partial z} a_y$$

$$J_d = -40 \cos(\omega t - 4z) \times 10^{-3} a_y = \underline{\underline{-40 \cos(\omega t - 4z) a_y}} \quad \text{mA/m}^2$$

$$\text{Prob. 10.13 (a)} \quad \frac{\sigma}{\omega \epsilon} = \frac{10^{-6}}{2\pi \times 10^7 \times 5 \times \frac{10^{-9}}{36\pi}} = 3.6 \times 10^{-4} \ll 1$$

Thus, the material is lossless at this frequency.

$$(b) \beta = \omega \sqrt{\mu \epsilon} = \frac{2\pi \times 10^7}{3 \times 10^8} \sqrt{5 \times 750} = \underline{\underline{12.83}} \text{ rad/m}$$

$$\lambda = \frac{2\pi}{\beta} = \frac{2\pi}{12.83} = \underline{\underline{0.49}} \text{ m}$$

$$(c) \text{ Phase difference} = \beta l = \underline{\underline{25.66}} \text{ rad}$$

$$(d) \eta = \sqrt{\mu / \epsilon} = 120\pi \sqrt{\frac{\mu_r}{\epsilon_r}} = 120\pi \sqrt{\frac{750}{5}} = \underline{\underline{4617}} \Omega$$

Prob. 10.14 If \mathbf{A} is a uniform vector and $\Phi(r)$ is a scalar,

$$\nabla \times (\Phi \mathbf{A}) = \nabla \Phi \times \mathbf{A} + \Phi (\nabla \times \mathbf{A}) = \nabla \Phi \times \mathbf{A}$$

since $\nabla \times \mathbf{A} = 0$.

$$\begin{aligned} \nabla \times \mathbf{E} &= \left(\frac{\partial}{\partial x} a_x + \frac{\partial}{\partial y} a_y + \frac{\partial}{\partial z} a_z \right) \times \mathbf{E}_0 e^{j(k_x x + k_y y + k_z z - \omega t)} = j(k_x a_x + k_y a_y + k_z a_z) e^{j(\quad)} \times \mathbf{E}_0 \\ &= j k \times \mathbf{E}_0 e^{j(\quad)} = j k \times \mathbf{E} \end{aligned}$$

$$\text{Also, } -\frac{\partial \mathbf{B}}{\partial t} = j\omega \mu \mathbf{H}. \quad \text{Hence } \nabla \times \mathbf{E} = -\frac{\partial \mathbf{B}}{\partial t} \text{ becomes } k \times \mathbf{E} = \omega \mu \mathbf{H}$$

From this, $\underline{\underline{a_k \times a_E = a_H}}$

Prob. 10.15

$$\begin{aligned} \nabla \cdot \mathbf{E} &= \left(\frac{\partial}{\partial x} a_x + \frac{\partial}{\partial y} a_y + \frac{\partial}{\partial z} a_z \right) \cdot \mathbf{E}_0 e^{j(k_x x + k_y y + k_z z - \omega t)} = j(k_x a_x + k_y a_y + k_z a_z) e^{j(\quad)} \cdot \mathbf{E}_0 \\ &= j k \cdot \mathbf{E}_0 e^{j(\quad)} = j k \cdot \mathbf{E} = 0 \quad \longrightarrow \quad k \cdot \mathbf{E} = 0 \end{aligned}$$

Similarly,

$$\nabla \cdot \mathbf{H} = j k \cdot \mathbf{H} = 0 \quad \longrightarrow \quad k \cdot \mathbf{H} = 0$$

It has been shown in Prob. 10.14 that

$$\nabla \times \mathbf{E} = -\frac{\partial \mathbf{B}}{\partial t} \quad \longrightarrow \quad k \times \mathbf{E} = \omega \mu \mathbf{H}$$

Similarly,

$$\nabla_x H = \frac{\partial D}{\partial t} \longrightarrow kxH = -\epsilon\omega E$$

$$\text{From } kxE = \omega\mu H, \quad a_k x a_E = a_H \quad \text{and}$$

$$\text{From } kxH = -\epsilon\omega E, \quad a_k x a_H = -a_E$$

Prob. 10.16 (a)

$$\beta = \frac{\omega}{c} \sqrt{\epsilon_r} \longrightarrow \sqrt{\epsilon_r} = \frac{\beta c}{\omega} = \frac{5 \times 3 \times 10^8}{2\pi \times 10^8} = \frac{15}{2\pi}$$

$$\underline{\underline{\epsilon_r = 5.6993}}$$

$$(b) \quad \lambda = 2\pi / \beta = 2\pi / 5 = \underline{\underline{1.2566 \text{ m}}}$$

$$u = \frac{c}{\sqrt{\mu_r \epsilon_r}} = \frac{3 \times 10^8}{\frac{15}{2\pi}} = \underline{\underline{1.257 \times 10^8 \text{ m/s}}}$$

$$(c) \quad \eta = \eta_0 \sqrt{\frac{\mu_r}{\epsilon_r}} = \frac{120\pi}{\frac{15}{2\pi}} = \underline{\underline{157.91 \Omega}}$$

$$(d) \quad a_E x a_H = a_k \longrightarrow a_E x a_z = a_x \longrightarrow a_E = \underline{\underline{a_y}}$$

$$(e) \quad E = 30 \times 10^{-3} (157.91) \sin(\omega t - \beta x) a_E = \underline{\underline{4.737 \sin(2\pi \times 10^8 t - 5x) a_y \text{ V/m}}}$$

$$(f) \quad J_d = \frac{\partial D}{\partial t} = \nabla_x H = \underline{\underline{0.15 \cos(2\pi \times 10^8 t - 5x) a_y \text{ A/m}}}$$

$$\text{Prob. 10.17} \quad \beta = \omega \sqrt{\mu\epsilon} = \frac{\omega}{c} \sqrt{\epsilon_r \mu_r}, \quad \mu_r = 1$$

$$\sqrt{\epsilon_r} = \frac{\beta c}{\omega} = \frac{8 \times 3 \times 10^8}{10^9} = 2.4 \longrightarrow \underline{\underline{\epsilon_r = 5.76}}$$

$$\text{Let } \mathbf{E} = \mathbf{E}_1 + \mathbf{E}_2$$

$$E_1 = 50 \cos(10^9 t - 8x) a_y, \quad E_2 = 40 \sin(10^9 t - 8x) a_z$$

$$H_1 = H_{o1} \cos(10^9 t - 8x) a_{H1}, \quad H_{o1} = \frac{50 \times 2.4}{120\pi} = \frac{1}{\pi}$$

$$a_{E1} \times a_{H1} = a_{k1} \longrightarrow a_y \times a_{H1} = a_x \longrightarrow a_{H1} = a_z$$

$$H_1 = \frac{1}{\pi} \cos(10^9 t - 8x) a_z$$

$$H_2 = H_{o2} \sin(10^9 t - 8x) a_{H2}, \quad H_{o2} = \frac{40 \times 2.4}{120\pi} = \frac{0.8}{\pi}$$

$$a_{E2} \times a_{H2} = a_{k2} \longrightarrow a_z \times a_{H2} = a_x \longrightarrow a_{H2} = -a_y$$

$$H_2 = -\frac{0.8}{\pi} \sin(10^9 t - 8x) a_y$$

$$\mathbf{H} = \mathbf{H}_1 + \mathbf{H}_2 = \underline{\underline{-0.2546 \sin(10^9 t - 8x) a_y + 0.3183 \cos(10^9 t - 8x) a_z}} \quad \text{A/m}$$

Prob. 10.18 $\beta = \omega \sqrt{\mu \epsilon} = \frac{\omega}{c} \sqrt{\mu_r \epsilon_r} = \frac{2\pi \times 10^7}{3 \times 10^8} (10) = \underline{\underline{2.0943}} \text{ rad/m}$

$$H = -\frac{1}{\mu} \int \nabla \times E dt$$

$$\nabla \times E = \begin{vmatrix} \frac{\partial}{\partial x} & \frac{\partial}{\partial y} & \frac{\partial}{\partial z} \\ 0 & E_y(x) & E_z(x) \end{vmatrix} = -\frac{\partial E_z}{\partial x} a_y + \frac{\partial E_y}{\partial x} a_z = -10\beta \sin(\omega t - \beta x)(a_y - a_z)$$

$$H = -\frac{10\beta}{\omega \mu} \cos(\omega t - \beta x)(a_y - a_z) = -\frac{10 \times 2\pi / 3}{2\pi \times 10^7 \times 50 \times 4\pi \times 10^{-7}} \cos(\omega t - \beta x)(a_y - a_z)$$

$$\underline{\underline{H = 5.305 \cos(2\pi \times 10^7 t - 2.0943x)(-a_y + a_z)} \quad \text{mA/m}}$$

Prob. 10.19 For a good conductor, $\frac{\sigma}{\omega \epsilon} \gg 1$, say $\frac{\sigma}{\omega \epsilon} > 100$

$$(a) \quad \frac{\sigma}{\omega \epsilon} = \frac{10^{-2}}{2\pi \times 8 \times 10^6 \times 15 \times \frac{10^{-9}}{36\pi}} = 1.5 \quad \longrightarrow \quad \text{lossy}$$

No, not conducting.

$$(b) \quad \frac{\sigma}{\omega \epsilon} = \frac{0.025}{2\pi \times 8 \times 10^6 \times 16 \times \frac{10^{-9}}{36\pi}} = 3.515 \quad \longrightarrow \quad \text{lossy}$$

No, not conducting.

$$(c) \quad \frac{\sigma}{\omega \epsilon} = \frac{25}{2\pi \times 8 \times 10^6 \times 81 \times \frac{10^{-9}}{36\pi}} = 694.4 \quad \longrightarrow \quad \text{conducting}$$

Yes, conducting.

Prob. 10.20

$$\alpha = \omega \sqrt{\frac{\mu \epsilon}{2} \left[\sqrt{1 + \left(\frac{\sigma}{\omega \epsilon} \right)^2} - 1 \right]} = \frac{2\pi f}{c} \sqrt{\frac{\mu_r \epsilon_r}{2} [\sqrt{1.0049} - 1]} = \frac{2\pi \times 6 \times 10^6}{3 \times 10^8} \sqrt{\frac{4}{2} \times 2.447 \times 10^{-3}}$$

$$\alpha = 8.791 \times 10^{-3}$$

$$\delta = 1/\alpha = 113.75 \text{ m}$$

$$\beta = \omega \sqrt{\frac{\mu \epsilon}{2} \left[\sqrt{1 + \left(\frac{\sigma}{\omega \epsilon} \right)^2} + 1 \right]} = \frac{4\pi}{100} \sqrt{\frac{4}{2} [\sqrt{1.0049} + 1]} = 0.2515$$

$$u = \omega / \beta = \frac{2\pi \times 6 \times 10^6}{0.2525} = \underline{\underline{1.5 \times 10^8}} \text{ m/s}$$

Prob. 10.21

$$0.4E_o = E_o e^{-\alpha z} \quad \longrightarrow \quad \frac{1}{0.4} = e^{2\alpha}$$

$$\text{Or } \alpha = \frac{1}{2} \ln \frac{1}{0.4} = 0.4581 \quad \longrightarrow \quad \delta = 1/\alpha = \underline{\underline{2.183}} \text{ m}$$

$$\lambda = 2\pi / \beta = 2\pi / 1.6$$

$$u = f\lambda = 10^7 \times \frac{2\pi}{1.6} = \underline{\underline{3.927 \times 10^7}} \text{ m/s}$$

Prob. 10.22 (a)

$$R_{dc} = \frac{l}{\sigma S} = \frac{l}{\sigma \pi a^2} = \frac{600}{5.8 \times 10^7 \times \pi \times (1.2)^2 \times 10^{-6}} = 2.287 \Omega$$

(b) $R_{ac} = \frac{l}{\sigma 2\pi a \delta}$. At 100 MHz, $\delta = 6.6 \times 10^{-3}$ mm for copper (see Table 10.2).

$$R_{ac} = \frac{600}{5.8 \times 10^7 \times 2\pi \times (1.2) \times 6.6 \times 10^{-3} \times 10^{-6}} = \underline{\underline{207.88 \Omega}}$$

(c) $\frac{R_{ac}}{R_{dc}} = \frac{a}{2\delta} = 1 \longrightarrow \delta = a/2 = \frac{66.1 \times 10^{-3}}{\sqrt{f}}$

$$\sqrt{f} = \frac{66.1 \times 2 \times 10^{-3}}{a} = \frac{66.1 \times 2}{1.2} \longrightarrow f = \underline{\underline{121.7 \text{ kHz}}}$$

Prob. 10.23

$$\omega = 10^6 \pi = 2\pi f \longrightarrow f = 0.5 \times 10^6$$

$$\delta = \frac{l}{\sqrt{\pi f \sigma \mu}} = \frac{l}{\sqrt{\pi \times 0.5 \times 10^6 \times 3.5 \times 10^7 \times 4\pi \times 10^{-7}}} = \underline{\underline{0.1203 \text{ mm}}}$$

$$R_{ac} = \frac{l}{\sigma \delta w}$$

since δ is very small, $w = 2\pi \rho_{outer}$

$$R_{ac} = \frac{l}{\sigma 2\pi \rho_{outer} \delta} = \frac{40}{3.5 \times 10^7 \times 0.1203 \times 2\pi \times 12 \times 10^{-6}} = \underline{\underline{0.126 \Omega}}$$

Prob. 10.24 $\alpha = \beta = 1/\delta$

$$\lambda = 2\pi / \beta = 2\pi \delta = 6.283\delta \longrightarrow \delta = 0.1591\lambda$$

showing that δ is shorter than λ .

Prob. 10.25

$$t = 5\delta = \frac{5}{\sqrt{\pi f \mu \sigma}} = \frac{5}{\sqrt{\pi \times 12 \times 10^9 \times 4\pi \times 10^{-7} \times 6.1 \times 10^7}} = \underline{\underline{2.94 \times 10^{-6} \text{ m}}}$$

Prob. 10.26 (a)

$$E = \operatorname{Re}[E_r e^{j\omega t}] = (5a_x + 12a_y)e^{-0.2z} \cos(\omega t - 3.4z)$$

$$\text{At } z = 4\text{m, } t = T/8, \quad \omega t = \frac{2\pi T}{T} \frac{T}{8} = \frac{\pi}{4}$$

$$E = (5a_x + 12a_y)e^{-0.8} \cos(\pi/4 - 13.6)$$

$$|E| = 13e^{-0.8} |\cos(\pi/4 - 13.6)| = \underline{5.662}$$

(b) loss = $\alpha \Delta z = 0.2(3) = 0.6$ Np. Since 1 Np = 8.686 dB,

$$\text{loss} = 0.6 \times 8.686 = \underline{5.212 \text{ dB}}$$

$$(c) \text{ Let } x = \sqrt{1 + \left(\frac{\sigma}{\omega \epsilon}\right)^2}$$

$$\frac{\alpha}{\beta} = \left(\frac{x-1}{x+1}\right)^{1/2} = 0.2/3.4 = \frac{1}{17}$$

$$\frac{x-1}{x+1} = 1/289 \quad \longrightarrow \quad x = 1.00694$$

$$\alpha = \omega \sqrt{\mu \epsilon / 2} \sqrt{x-1} = \frac{\omega}{c} \sqrt{\epsilon_r / 2} \sqrt{x-1}$$

$$\sqrt{\frac{\epsilon_r}{2}} = \frac{\alpha c}{\omega \sqrt{x-1}} = \frac{0.2 \times 3 \times 10^3}{10^8 \sqrt{0.00694}} = 2.4 \quad \longrightarrow \quad \epsilon_r = 11.52$$

$$|\eta| = \frac{\sqrt{\frac{\mu_o}{\epsilon_o}} \cdot \frac{1}{\sqrt{\epsilon_r}}}{\sqrt{x}} = \frac{120\pi}{\sqrt{11.52 \times 1.00694}} = 32.5$$

$$\tan 2\theta_\eta = \frac{\sigma}{\omega \epsilon} = \sqrt{x^2 - 1} = 0.118 \quad \longrightarrow \quad \theta_\eta = 3.365^\circ$$

$$\eta = 32.5 \angle 3.365^\circ$$

$$H_s = a_k x \frac{E_s}{\eta} = \frac{a_z}{\eta} x (5a_x + 12a_y) e^{-\gamma z} = \frac{(5a_x + 12a_y)}{|\eta|} e^{-j3.365^\circ} e^{-\gamma z}$$

$$H = (-369.2a_x + 153.8a_y) e^{-0.2z} \cos(\omega t - 3.4z - 3.365^\circ) \text{ mA}$$

$$P = ExH = \begin{vmatrix} 5 & 12 & 0 \\ -369.2 & 153.8 & 0 \end{vmatrix} x 10^{-3} e^{-0.4z} \cos(\omega t - 3.4z) \cos(\omega t - 3.4z - 3.365^\circ)$$

$$P = 5.2e^{-0.4z} \cos(\omega t - 3.4z) \cos(\omega t - 3.4z - 3.365^\circ) a_z$$

At $z = 4$, $t = T/4$,

$$P = 5.2e^{-1.6} \cos(\pi/4 - 13.6) \cos(\pi/4 - 13.6 - 0.0587) a_z = \underline{\underline{0.9702 a_z \text{ W/m}^2}}$$

Prob. 10.27 (a) This is a lossless medium,

$$\beta = \omega \sqrt{\mu\epsilon}, \quad \eta = \sqrt{\frac{\mu}{\epsilon}}$$

$$\eta = \frac{\omega \mu_0}{\beta} = \frac{2\pi \times 10^8 \times 4\pi \times 10^{-7}}{6} = \underline{\underline{131.6 \Omega}}$$

(b) $E_o = \eta H_o = 131.6 \times 30 \times 10^{-3} = 3.948$

$$a_E \cdot x a_H = a_k \longrightarrow a_E \cdot x a_y = a_x \longrightarrow a_E = -a_z$$

$$P = ExH = \eta H_o^2 \cos^2(2\pi \times 10^8 t - 6x) a_x = \underline{\underline{0.1184 \cos^2(2\pi \times 10^8 t - 6x) a_x \text{ W/m}^2}}$$

(c) $\mathcal{P}_{ave} = \frac{1}{2} \eta H_o^2 = 0.0592 a_x \text{ W/m}^2$

$$P_{ave} = \int \mathcal{P}_{ave} \cdot dS = \mathcal{P}_{ave} \cdot S = 0.0592 \times 3 \times 2 = \underline{\underline{0.3552 \text{ W}}}$$

Prob. 10.28 Let $E_s = E_r + jE_i$ and $H_s = H_r + jH_i$

$$E = \text{Re}(E_s e^{j\omega t}) = E_r \cos \omega t - E_i \sin \omega t$$

Similarly,

$$H = H_r \cos \omega t - H_i \sin \omega t$$

$$\mathcal{P} = E_x H = E_r x H_r \cos^2 \omega t + E_i x H_i \sin^2 \omega t - \frac{1}{2} (E_r x H_i + E_i x H_r) \sin 2\omega t$$

$$\mathcal{P}_{\text{ave}} = \frac{1}{T} \int_0^T \mathcal{P} dt = \frac{1}{T} \int_0^T \cos^2 \omega t dt (E_r x H_r) + \frac{1}{T} \int_0^T \sin^2 \omega t dt (E_i x H_i) - \frac{1}{2T} \int_0^T \sin 2\omega t dt (E_r x H_i + E_i x H_r)$$

$$= \frac{1}{2} (E_r x H_r + E_i x H_i) = \frac{1}{2} \text{Re}[(E_r + jE_i)x(H_r - jH_i)]$$

$$\mathcal{P}_{\text{ave}} = \frac{1}{2} \text{Re}(E_x H_x^*)$$

as required.

Prob. 10.29 (a)

$$u = \omega / \beta \quad \longrightarrow \quad \omega = u\beta = \frac{\beta}{c} \frac{1}{\sqrt{4.5}} = \frac{2 \times 3 \times 10^8}{\sqrt{4.5}} = \underline{\underline{2.828 \times 10^8}} \text{ rad/s}$$

$$\eta = \frac{120\pi}{\sqrt{4.5}} = 177.7 \Omega$$

$$H = a_k x \frac{E}{\eta} = \frac{a_z}{\eta} x \frac{40}{\rho} \sin(\omega t - 2z) a_\rho = \frac{0.225}{\rho} \sin(\omega t - 2z) a_\phi \text{ A/m}$$

$$(b) \quad \mathcal{P} = E_x H = \frac{9}{\rho^2} \sin^2(\omega t - 2z) a_z \text{ W/m}^2$$

$$(c) \quad \mathcal{P}_{\text{ave}} = \frac{4.5}{\rho^2} a_z, \quad dS = \rho d\phi d\rho a_z$$

$$P_{\text{ave}} = \int \mathcal{P}_{\text{ave}} \cdot dS = 4.6 \int_{2\text{mm}}^{3\text{mm}} \frac{d\rho}{\rho} \int_0^{2\pi} d\phi = 4.5 \ln(3/2)(2\pi) = \underline{\underline{11.46 \text{ W}}}$$

$$\text{Prob. 10.30 (a)} \quad P_{i,\text{ave}} = \frac{E_{i0}^2}{2\eta_1}, \quad P_{r,\text{ave}} = \frac{E_{r0}^2}{2\eta_1}, \quad P_{t,\text{ave}} = \frac{E_{t0}^2}{2\eta_2}$$

$$R = \frac{P_{r,\text{ave}}}{P_{i,\text{ave}}} = \frac{E_{r0}^2}{E_{i0}^2} = \Gamma^2 = \left(\frac{\eta_2 - \eta_1}{\eta_2 + \eta_1} \right)^2$$

$$R = \left(\frac{\sqrt{\frac{\mu_o}{\epsilon_2}} - \sqrt{\frac{\mu_o}{\epsilon_1}}}{\sqrt{\frac{\mu_o}{\epsilon_2}} + \sqrt{\frac{\mu_o}{\epsilon_1}}} \right)^2 = \left(\frac{\sqrt{\mu_o \epsilon_1} - \sqrt{\mu_o \epsilon_2}}{\sqrt{\mu_o \epsilon_1} + \sqrt{\mu_o \epsilon_2}} \right)^2$$

Since $n_1 = c\sqrt{\mu_1 \epsilon_1} = c\sqrt{\mu_o \epsilon_1}$, $n_2 = c\sqrt{\mu_o \epsilon_2}$,

$$R = \left(\frac{n_1 - n_2}{n_1 + n_2} \right)^2$$

$$T = \frac{P_{t,ave}}{P_{i,ave}} = \frac{\eta_1 E_{to}^2}{\eta_2 E_{io}^2} = \frac{\eta_1}{\eta_2} \tau^2 = \frac{4n_1 n_2}{(n_1 + n_2)^2}$$

(b) If $P_{r,ave} = P_{t,ave} \longrightarrow RP_{i,ave} = TP_{i,ave} \longrightarrow R = T$

i.e. $(n_1 - n_2)^2 = 4n_1 n_2 \longrightarrow n_1^2 - 6n_1 n_2 + n_2^2 = 0$

$$\frac{n_1}{n_2} = 3 \pm \sqrt{8} = \underline{\underline{5.828}} \quad \text{or} \quad \underline{\underline{0.1716}}$$

Prob. 10.31 (a) $\eta_1 = \eta_o$, $\eta_o = \sqrt{\frac{\mu}{\epsilon}} = \eta_o / 2$

$$\Gamma = \frac{\eta_2 - \eta_1}{\eta_2 + \eta_1} = \frac{\eta_o/2 - \eta_o}{3\eta_o/2} = \underline{\underline{-1/3}}, \quad \tau = \frac{2\eta_2}{\eta_2 + \eta_1} = \frac{\eta_o}{3\eta_o/2} = \underline{\underline{2/3}}$$

$$s = \frac{1+|\Gamma|}{1-|\Gamma|} = \frac{1+1/3}{1-1/3} = \underline{\underline{2}}$$

(b) $E_{or} = \Gamma E_{oi} = -\frac{1}{3} \times (30) = -10$

$$\underline{\underline{E_r = -10 \cos(\omega t + z) a_x}} \quad \text{V/m}$$

Let $H_r = H_{or} \cos(\omega t + z) a_H$

$$a_E \times a_H = a_k \longrightarrow -a_k \times a_H = -a_z \longrightarrow a_H = a_x$$

$$H_r = \frac{10}{120\pi} \cos(\omega t + z) a_y = \underline{\underline{26.53 \cos(\omega t + z) a_y}} \text{ mA/m}$$

Prob. 10.32 (a) $\eta_1 = \eta_o$

$$E_i = E_{io} \sin(\omega t - 5x) a_z$$

$$E_{io} = H_{io} \eta_o = 120\pi \times 4 = 480\pi$$

$$a_E \times a_H = a_k \longrightarrow a_E \times a_y = a_x \longrightarrow a_E = -a_z$$

$$E_i = -480\pi \sin(\omega t - 5x) a_z$$

$$\eta_2 = \sqrt{\frac{\mu_o}{\epsilon_o}} = \frac{120\pi}{\sqrt{4}} = 60\pi$$

$$\Gamma = \frac{\eta_2 - \eta_1}{\eta_2 + \eta_1} = \frac{60\pi - 120\pi}{60\pi + 120\pi} = -1/3, \quad \tau = 1 + \Gamma = 2/3$$

$$E_{ro} = \Gamma E_{io} = (-1/3)(480\pi) = -160\pi$$

$$E_r = 160\pi \sin(\omega t + 5x) a_z$$

$$E_t = E_i + E_r = \underline{\underline{-1.508 \sin(\omega t - 5x) a_z + 0.503 \sin(\omega t + 5x) a_z}} \text{ kV/m}$$

(b) $E_{io} = \tau E_{io} = (2/3)(480\pi) = 320\pi$

$$\mathcal{P} = \frac{E_{io}^2}{2\eta_2} a_x = \frac{(320\pi)^2}{2(60\pi)} a_x = \underline{\underline{2.68 a_x \text{ kW/m}^2}}$$

(c) $s = \frac{1+|\Gamma|}{1-|\Gamma|} = \frac{1+1/3}{1-1/3} = 2$

Prob. 10.33 $\eta_1 = \eta_o = 120\pi, \quad \eta_2 = \sqrt{\frac{\mu_2}{\epsilon_2}}$

$$\frac{E_{ro}}{E_{io}} = \Gamma = \frac{\eta_2 - \eta_1}{\eta_2 + \eta_1} \quad (1)$$

But $E_{ro} = \eta_o H_{ro} \quad (2)$

Combining (1) and (2),

$$E_{ro} = \eta_o H_{ro} = \left(\frac{\eta_2 - \eta_1}{\eta_2 + \eta_1} \right) E_{io} \quad \longrightarrow \quad \eta_o = \left(\frac{\eta_2 - \eta_1}{\eta_2 + \eta_1} \right) \frac{E_{io}}{H_{ro}}$$

$$\text{But } \frac{E_{io}}{H_{ro}} = \frac{3.6}{1.2 \times 10^{-3}} = 3000$$

$$\eta_o = 3000 \left(\frac{\eta_2 - \eta_1}{\eta_2 + \eta_1} \right) \quad \longrightarrow \quad 377 = 3000 \left(\frac{\eta_2 - 377}{\eta_2 + 377} \right)$$

$$\text{Thus, } \eta_2 = 485.37. \quad \text{Since } \eta_2 = \sqrt{\frac{\mu_2}{\epsilon_2}},$$

$$\mu_2 = \epsilon_o \epsilon_r \eta_2^2 = \frac{10^{-9}}{36\pi} \times 12.5 (485.37)^2 = \underline{\underline{2.604 \times 10^{-5} \text{ H/m}}}$$

$$\text{Prob. 10.34 } \eta_1 = \sqrt{\frac{\mu_1}{\epsilon_1}} = \eta_o / 2, \quad \eta_2 = \eta_o$$

$$\Gamma = \frac{\eta_2 - \eta_1}{\eta_2 + \eta_1} = 1/3, \quad \tau = 1 + \Gamma = 4/3$$

$$E_{or} = \Gamma E_{io} = (1/3)(5) = 5/4, \quad E_{ot} = \tau E_{io} = 20/3$$

$$\beta = \frac{\omega}{c} \sqrt{\mu_r \epsilon_r} = \frac{10^8}{3 \times 10^8} \sqrt{4} = 2/3$$

$$(a) \quad E_r = \frac{5}{3} \cos(10^8 t - 2y/3) a_z$$

$$E_t = E_i + E_r = \underline{\underline{5 \sin(10^8 t + \frac{2}{3}y) a_z + \frac{5}{3} \cos(10^8 t - \frac{2}{3}y) a_z}} \quad \text{V/m}$$

$$(b) \quad \mathcal{P}_{\text{ave1}} = \frac{E_{io}^2}{2\eta_1} (-a_y) + \frac{E_{ro}^2}{2\eta_1} (+a_y) = \frac{25}{2(60\pi)} \left(1 - \frac{1}{9}\right) (-a_y) = \underline{\underline{-0.0589 a_y \text{ W/m}^2}}$$

$$(c) \quad \mathcal{P}_{\text{ave2}} = \frac{E_{io}^2}{2\eta_2} (-a_y) = \frac{400}{9(2)(120\pi)} (-a_y) = \underline{\underline{-0.0589 a_y \text{ W/m}^2}}$$

Prob. 10.35 (a) $\beta = l = \omega / u = \frac{\omega}{c} \sqrt{\mu_r \epsilon_r}$

$$\omega = \frac{c}{\sqrt{\mu_r \epsilon_r}} = \frac{3 \times 10^8}{\sqrt{3 \times 12}} = \underline{\underline{0.5 \times 10^8 \text{ rad/s}}}$$

(b) $\eta_1 = \eta_o, \quad \eta_2 = \eta_o \sqrt{\frac{\mu_r}{\epsilon_r}} = \eta_o \sqrt{\frac{3}{12}} = \eta_o / 2$

$$\Gamma = \frac{\eta_2 - \eta_1}{\eta_2 + \eta_1} = -1/3, \quad \tau = 1 + \Gamma = 2/3$$

$$s = \frac{1 + |\Gamma|}{1 - |\Gamma|} = \frac{1 + 1/3}{1 - 1/3} = \underline{\underline{2}}$$

(c) Let $H_r = H_{or} \cos(\omega t + z) a_H$, where

$$E_r = -\frac{1}{3}(3) \cos(\omega t + z) a_y = -10 \cos(\omega t + z) a_y, \quad H_{or} = \frac{10}{\eta_o} = \frac{10}{120\pi}$$

$$a_E x a_H = a_k \longrightarrow -a_y x a_H = -a_z \longrightarrow a_H = -a_x$$

$$H_r = -\frac{10}{120\pi} \cos(0.5 \times 10^8 t + z) a_x \text{ A/m} = -26.53 \cos(0.5 \times 10^8 t + z) a_x \text{ mA/m}$$

Prob. 10.36 (a)

$$a_E x a_H = a_k \longrightarrow a_E x a_z = a_x \longrightarrow a_E = -a_y$$

i.e. polarization is along the y-axis.

(b) $\beta = \omega \sqrt{\mu \epsilon} = \frac{2\pi f}{c} \sqrt{\mu_r \epsilon_r} = \frac{2\pi \times 30 \times 10^6}{3 \times 10^8} \sqrt{4 \times 9} = \underline{\underline{3.77 \text{ rad/m}}}$

(c) $J_d = \nabla \times H = \begin{vmatrix} \frac{\partial}{\partial x} & \frac{\partial}{\partial x} & \frac{\partial}{\partial x} \\ 0 & 0 & H_z(x,t) \end{vmatrix} = -\frac{\partial H_z}{\partial x} a_y$

$$= -10\beta \cos(\omega t + \beta x) a_y = \underline{\underline{-37.6 \cos(\omega t + \beta x) a_y \text{ mA/m}}}$$

$$(d) \eta_2 = \eta_o, \quad \eta_1 = \eta_o \sqrt{\frac{4}{9}} = \frac{2}{3} \eta_o$$

$$\Gamma = \frac{\eta_2 - \eta_1}{\eta_2 + \eta_1} = 1/5, \quad \tau = 1 + \Gamma = 6/5$$

$$E_i = 10\eta_1 \sin(\omega t + \beta x) a_E \text{ mV/m}, \quad a_E = -a_y$$

$$E_r = \Gamma 10\eta_1 \sin(\omega t - \beta x) (-a_y) \text{ mV/m}$$

$$a_E x a_H = a_k \longrightarrow -a_y x a_H = a_x \longrightarrow a_H = -a_z$$

$$H_r = \Gamma 10 \sin(\omega t - \beta x) (-a_z) \text{ mA/m} = \underline{\underline{-2 \sin(\omega t - \beta x) a_z \text{ mA/m}}}$$

$$E_t = \tau 10\eta_1 \sin(\omega t + \beta x) (-a_y) \text{ mV/m}$$

$$a_E x a_H = a_k \longrightarrow -a_y x a_H = -a_x \longrightarrow a_H = a_z$$

$$H_t = 10(6/5)(\eta_1/\eta_2) \sin(\omega t + \beta x) a_z \text{ mA/m} = \underline{\underline{8 \sin(\omega t + \beta x) a_z \text{ mA/m}}}$$

$$(e) \mathcal{P}_{\text{ave1}} = \frac{E_{io}^2}{2\eta_1} (-a_x) + \frac{E_{ro}^2}{2\eta_1} (+a_x) = \frac{-E_{io}^2}{2\eta_1} (1 - \Gamma^2) a_x$$

$$= -\frac{\eta_1^2 H_{io}^2}{2\eta_1} (1 - \Gamma^2) a_x = -\frac{1}{3} \eta_o 100 (1 - \frac{1}{25}) a_x = \underline{\underline{-0.012064 a_x \text{ W/m}^2}}$$

$$E_{ot} = \tau E_{oi} = \tau \eta_1 H_{io}$$

$$\mathcal{P}_{\text{ave2}} = \frac{E_{io}^2}{2\eta_2} (-a_x) = \frac{\tau^2 \eta_1^2 H_{io}^2}{2\eta_2} (-a_x) = 32\eta_o (-a_x) \mu\text{W/m}^2 = \underline{\underline{-0.012064 a_x \text{ W/m}^2}}$$

Prob. 10.37 (a) In air, $\beta_1 = 1, \lambda_1 = 2\pi/\beta_1 = 2\pi = \underline{\underline{6.283 \text{ m}}}$

$$\omega = \beta_1 c = \underline{\underline{3 \times 10^8 \text{ rad/s}}}$$

In the dielectric medium, ω is the same.

$$\omega = \underline{\underline{3 \times 10^8 \text{ rad/s}}}$$

$$\beta_2 = \frac{\omega}{c} \sqrt{\epsilon_{r2}} = \beta_1 \sqrt{\epsilon_{r2}} = \sqrt{3}$$

$$\lambda_2 = \frac{2\pi}{\beta_2} = \frac{2\pi}{\sqrt{3}} = \underline{\underline{3.6276 \text{ m}}}$$

$$(b) \quad H_o = \frac{E_o}{\eta_o} = \frac{10}{120\pi} = 0.0265$$

$$a_H = a_k x a_E = a_z x a_y = a_x$$

$$H_i = \underline{\underline{-26.5 \cos(\omega t - z) a_x \text{ mA/m}}}$$

$$(c) \quad \eta_1 = \eta_o, \quad \eta_2 = \eta_o / \sqrt{3}$$

$$\Gamma = \frac{\eta_2 - \eta_1}{\eta_2 + \eta_1} = \frac{(1/\sqrt{3}) - 1}{(1/\sqrt{3}) + 1} = \underline{\underline{-0.268}}, \quad \tau = 1 + \Gamma = \underline{\underline{0.732}}$$

$$(d) \quad E_{io} = \tau E_o = 7.32, \quad E_{ro} = \Gamma E_o = -2.68$$

$$E_i = E_o + E_r = \underline{\underline{10 \cos(\omega t - z) a_y - 2.68 \cos(\omega t + z) a_y \text{ V/m}}}$$

$$E_2 = E_i = \underline{\underline{7.32 \cos(\omega t - z) a_y \text{ V/m}}}$$

$$\mathcal{P}_{\text{ave1}} = \frac{1}{2\eta_1} (a_z) [E_{io}^2 - E_{ro}^2] = \frac{1}{2(120\pi)} (a_z) (10^2 - 2.68^2) = \underline{\underline{0.1231 a_z \text{ W/m}^2}}$$

$$\mathcal{P}_{\text{ave2}} = \frac{E_{io}^2}{2\eta_2} (a_z) = \frac{\sqrt{3}}{2 \times 120\pi} (7.32)^2 (a_z) = \underline{\underline{0.1231 a_z \text{ W/m}^2}}$$

$$\text{Prob. 10.38 (a)} \quad \omega = \beta c = 3 \times 3 \times 10^8 = \underline{\underline{9 \times 10^8 \text{ rad/s}}}$$

$$(b) \quad \lambda = 2\pi / \beta = 2\pi / 3 = \underline{\underline{2.094}}$$

$$(c) \quad \frac{\sigma}{\omega \epsilon} = \frac{4}{9 \times 10^8 \times 80 \times 10^{-9} / 36\pi} = 2\pi = \underline{\underline{6.288}}$$

$$\tan 2\theta_n = \frac{\sigma}{\omega \epsilon} = 6.288 \quad \longrightarrow \quad \theta_n = 40.47^\circ$$

$$|\eta_2| = \frac{\sqrt{\mu_2/\epsilon_2}}{\sqrt{1 + \left(\frac{\sigma_2}{\omega\epsilon_2}\right)^2}} = \frac{377/\sqrt{80}}{\sqrt{1 + 4\pi^2}} = 16.71$$

$$\eta_2 = \underline{16.71 \angle 40.47^\circ \Omega}$$

$$(d) \Gamma = \frac{\eta_2 - \eta_1}{\eta_2 + \eta_1} = \frac{16.71 \angle 40.47^\circ - 377}{16.71 \angle 40.47^\circ + 377} = 0.935 \angle 176.7^\circ$$

$$E_{or} = \Gamma E_{oi} = 9.35 \angle 176.7^\circ$$

$$E_r = \underline{9.35 \sin(\omega t - 3z + 176.7^\circ) a_x \text{ V/m}}$$

$$\alpha_2 = \frac{\omega}{c} \sqrt{\frac{\mu_{r2}\epsilon_{r2}}{2} \left[\sqrt{1 + \left(\frac{\sigma_2}{\omega\epsilon_2}\right)^2} - 1 \right]} = \frac{9 \times 10^9}{3 \times 10^8} \sqrt{\frac{80}{2} \left[\sqrt{1 + 4\pi^2} - 1 \right]} = 43.94 \text{ Np/m}$$

$$\beta_2 = \frac{9 \times 10^9}{3 \times 10^8} \sqrt{\frac{80}{2} \left[\sqrt{1 + 4\pi^2} + 1 \right]} = 51.48 \text{ rad/m}$$

$$\tau = \frac{2\eta_2}{\eta_2 + \eta_1} = \frac{2 \times 16.71 \angle 40.47^\circ}{16.71 \angle 40.47^\circ + 377} = 0.0857 \angle 38.89^\circ$$

$$E_{ot} = \tau E_o = 0.857 \angle 38.59^\circ$$

$$\underline{E_t = 0.857 e^{43.94z} \sin(9 \times 10^8 t + 51.48z + 38.89^\circ) \text{ V/m}}$$

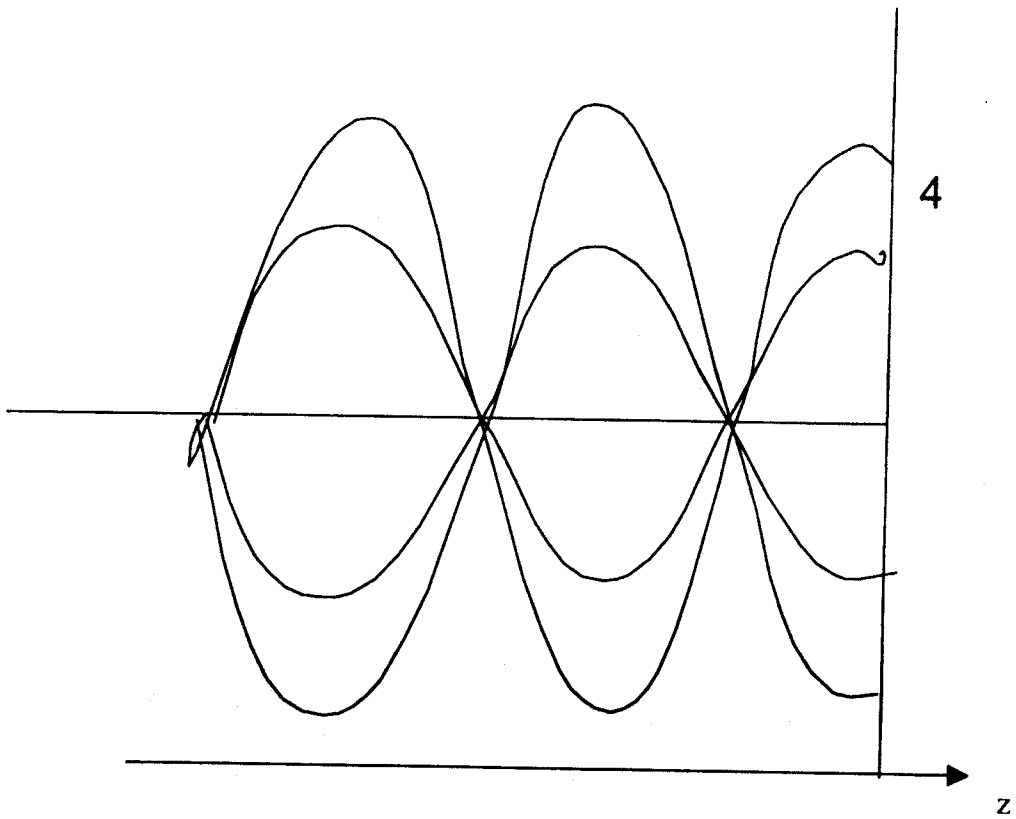
Prob. 10.39 $\sigma = 0$ $\sigma \approx \infty$ 

Curve 0 is at $t = 0$; curve 1 is at $t = T/8$; curve 2 is at $t = T/4$; curve 3 is at $t = 3T/8$, etc.

Prob. 10.40 Since $\mu_0 = \mu_1 = \mu_2$,

$$\sin \theta_{11} = \sin \theta_1 \sqrt{\frac{\epsilon_0}{\epsilon_1}} = \frac{\sin 45^\circ}{\sqrt{4.5}} = 0.3333 \quad \longrightarrow \quad \underline{\underline{\theta_{11} = 19.47^\circ}}$$

$$\sin \theta_{12} = \sin \theta_{11} \sqrt{\frac{\epsilon_2}{\epsilon_1}} = \frac{1}{3} \sqrt{\frac{2.25}{4.5}} = 0.2357 \quad \longrightarrow \quad \underline{\underline{\theta_{12} = 13.63^\circ}}$$

Prob. 10.41

$$E_x = \frac{20(e^{jk_x x} - e^{-jk_x x})}{2} \frac{(e^{jk_y y} - e^{-jk_y y})}{2} a_z$$

$$= -j5 \left[e^{j(k_x x + k_y y)} + e^{j(k_x x - k_y y)} - e^{-j(k_x x - k_y y)} - e^{-j(k_x x + k_y y)} \right] a_z$$

which consists of four plane waves.

$$\nabla \times E_s = -j\omega \mu_o H_s \quad \longrightarrow \quad H_s = \frac{j}{\omega \mu_o} \nabla \times E_s = \frac{j}{\omega \mu_o} \left(\frac{\partial E_z}{\partial y} a_x - \frac{\partial E_z}{\partial x} a_y \right)$$

$$H_s = -\frac{j20}{\omega \mu_o} \left[k_y \sin(k_x x) \sin(k_y y) a_x + k_x \cos(k_x x) \cos(k_y y) a_y \right]$$

Prob. 10.42 If $\mu_o = \mu_1 = \mu_2$, $\eta_1 = \frac{\eta_o}{\sqrt{\epsilon_{r1}}}$, $\eta_2 = \frac{\eta_o}{\sqrt{\epsilon_{r2}}}$

$$\Gamma_{\parallel} = \frac{\frac{I}{\sqrt{\epsilon_{r2}}} \cos \theta_t - \frac{I}{\sqrt{\epsilon_{r1}}} \cos \theta_i}{\frac{I}{\sqrt{\epsilon_{r2}}} \cos \theta_t + \frac{I}{\sqrt{\epsilon_{r1}}} \cos \theta_i}$$

$$\sqrt{\epsilon_{r1}} \sin \theta_i = \sqrt{\epsilon_{r2}} \sin \theta_t \quad \longrightarrow \quad \frac{\sqrt{\epsilon_{r2}}}{\sqrt{\epsilon_{r1}}} = \frac{\sin \theta_i}{\sin \theta_t}$$

$$\Gamma_{\parallel} = \frac{\cos \theta_t - \frac{\sin \theta_i}{\sin \theta_t} \cos \theta_i}{\cos \theta_t + \frac{\sin \theta_i}{\sin \theta_t} \cos \theta_i} = \frac{\sin \theta_t \cos \theta_t - \sin \theta_i \cos \theta_i}{\sin \theta_t \cos \theta_t + \sin \theta_i \cos \theta_i}$$

Dividing both numerator and denominator by $\cos \theta_t \cos \theta_i$, gives

$$\Gamma_{\parallel} = \frac{\tan \theta_t - \tan \theta_i}{\tan \theta_t + \tan \theta_i} = \frac{\frac{\tan \theta_t' - \tan \theta_i}{1 + \tan \theta_t \tan \theta_i}}{\frac{\tan \theta_t + \tan \theta_i}{1 + \tan \theta_t \tan \theta_i}} = \frac{\tan(\theta_t - \theta_i)}{\tan(\theta_t + \theta_i)}$$

Similarly,

$$\tau_{\parallel} = \frac{\frac{2}{\sqrt{\epsilon_{r2}}} \cos \theta_t}{\frac{I}{\sqrt{\epsilon_{r2}}} \cos \theta_t + \frac{I}{\sqrt{\epsilon_{r1}}} \cos \theta_i} = \frac{2 \cos \theta_t}{\cos \theta_t + \frac{\sin \theta_i}{\sin \theta_t} \cos \theta_i}$$

$$= \frac{2 \cos \theta_t \sin \theta_t}{\sin \theta_t \cos \theta_t (\sin^2 \theta_t + \cos^2 \theta_t) + \sin \theta_i \cos \theta_i (\sin^2 \theta_t + \cos^2 \theta_t)}$$

$$= \frac{2 \cos \theta, \sin \theta,}{(\sin \theta, \cos \theta, + \sin \theta, \cos \theta,)(\cos \theta, \cos \theta, + \sin \theta, \sin \theta,)}$$

$$= \frac{2 \cos \theta, \sin \theta,}{\sin(\theta, + \theta,) \cos(\theta, - \theta,)}$$

$$\Gamma_{\perp} = \frac{\frac{1}{\sqrt{\epsilon_{r2}}} \cos \theta, - \frac{1}{\sqrt{\epsilon_{r1}}} \cos \theta,}{\frac{1}{\sqrt{\epsilon_{r2}}} \cos \theta, + \frac{1}{\sqrt{\epsilon_{r1}}} \cos \theta,} = \frac{\cos \theta, - \frac{\sin \theta,}{\sin \theta,} \cos \theta,}{\cos \theta, + \frac{\sin \theta,}{\sin \theta,} \cos \theta,} = \frac{\sin(\theta, - \theta,)}{\sin(\theta, + \theta,)}$$

$$\tau_{\perp} = \frac{\frac{2}{\sqrt{\epsilon_{r2}}} \cos \theta,}{\frac{1}{\sqrt{\epsilon_{r2}}} \cos \theta, + \frac{1}{\sqrt{\epsilon_{r1}}} \cos \theta,} = \frac{2 \cos \theta,}{\cos \theta, + \frac{\sin \theta,}{\sin \theta,} \cos \theta,} = \frac{2 \cos \theta, \sin \theta,}{\sin(\theta, + \theta,)}$$

Prob. 10.43 (a) $k_i = 4a_y + 3a_z$

$$k_i \cdot a_n = k_i \cos \theta, \quad \longrightarrow \quad \cos \theta, = 4/5 \quad \longrightarrow \quad \theta, = \underline{\underline{36.87^\circ}}$$

(b)

$$\mathcal{P}_{\text{ave}} = \frac{1}{2} \operatorname{Re}(E_s \times H_s^*) = \frac{E_o^2}{2\eta} a_k = \frac{(\sqrt{8^2 + 6^2})^2 (3a_y + 4a_z)}{2 \times 120\pi \cdot 5} = \underline{\underline{79.58a_y + 106.1a_z \text{ mW/m}^2}}$$

(c) $\theta_r = \theta, = 36.87^\circ$. Let

$$E_r = (E_{r_x} a_x + E_{r_z} a_z) \sin(\omega t - k_r \cdot r)$$

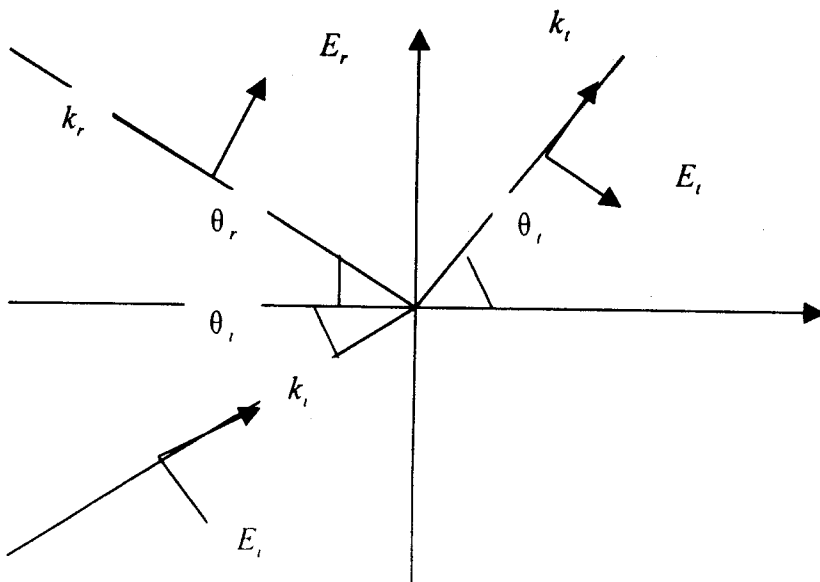

From the figure, $k_r = -k_{rz}a_z - k_{ry}a_y$. But $k_r = k_i = 5$

$$k_{rz} = k_r \sin\theta_r = 5(3/5) = 3, \quad k_{ry} = k_r \cos\theta_r = 5(4/5) = 4.$$

Hence, $k_r = -4a_y + 3a_z$

$$\sin\theta_i = \frac{n_1}{n_2} \sin\theta_r = \frac{c\sqrt{\mu_1\epsilon_1}}{c\sqrt{\mu_2\epsilon_2}} \sin\theta_r = \frac{3/5}{\sqrt{4}} = 0.3$$

$$\theta_i = 17.46, \cos\theta_i = 0.9539, \quad \eta_1 = \eta_o = 120\pi, \eta_2 = \eta_o / 2 = 60\pi$$

$$\Gamma_{11} = \frac{E_{ro}}{E_{io}} = \frac{\eta_2 \cos\theta_i - \eta_1 \cos\theta_r}{\eta_2 \cos\theta_i + \eta_1 \cos\theta_r} = \frac{\frac{\eta_o}{2}(0.9539) - \eta_o(0.8)}{\frac{\eta_o}{2}(0.9539) + \eta_o(0.8)} = -0.253$$

$$E_{ro} = \Gamma_{11} E_{io} = -0.253(10) = -2.53$$

$$\text{But } (E_{ry}a_y + E_{rz}a_z) = E_{ro}(\sin\theta_r a_y + \cos\theta_r a_z) = -2.53\left(\frac{3}{5}a_y + \frac{4}{5}a_z\right)$$

$$\underline{E_r = -(1.518a_y + 2.024a_z) \sin(\omega t + 4y - 3z) \text{ V/m}}$$

Similarly, let

$$E_i = (E_{iy}a_y + E_{iz}a_z) \sin(\omega t - k_i \cdot r)$$

$$k_i = \beta_2 = \omega \sqrt{\mu_2 \epsilon_2} = \omega \sqrt{4\mu_o \epsilon_o}$$

$$\text{But } k_i = \beta_1 = \omega \sqrt{\mu_o \epsilon_o}$$

$$\frac{k_i}{k_r} = 2 \quad \longrightarrow \quad k_i = 2k_r = 10$$

$$k_{iy} = k_i \cos\theta_i = 9.539, \quad k_{iz} = k_i \sin\theta_i = 3,$$

$$k_i = 9.539a_y + 3a_z$$

Note that $k_{iz} = k_{rz} = k_{iz} = 3$

$$\tau_{11} = \frac{E_{t0}}{E_{i0}} = \frac{2\eta_2 \cos\theta_i}{\eta_2 \cos\theta_i + \eta_1 \cos\theta_r} = \frac{\eta_o(0.8)}{\frac{\eta_o}{2}(0.9539) + \eta_o(0.8)} = 0.6265$$

$$E_{t0} = \tau_{11} E_{i0} = 0.265$$

But

$$(E_{ty} a_y + E_{tz} a_z) = E_{t0} (\sin\theta_i a_y - \cos\theta_i a_z) = 0.256(0.3a_y - 0.9539a_z)$$

Hence,

$$\underline{E_t = (1.877a_y - 5.968a_z) \sin(\omega t - 9.539y - 3z) \text{ V/m}}$$

Prob. 10.44 (a)

$$\tan\theta_i = \frac{k_{ix}}{k_{iz}} = \frac{1}{\sqrt{8}} \quad \longrightarrow \quad \underline{\theta_i = \theta_r = 19.47^\circ}$$

$$\sin\theta_i = \sin\theta_r \sqrt{\frac{\epsilon_{r1}}{\epsilon_{r2}}} = \frac{1}{3}(3) = 1 \quad \longrightarrow \quad \underline{\theta_i = 90^\circ}$$

$$(b) \quad \beta_1 = \frac{\omega}{c} \sqrt{\epsilon_{r1}} = \frac{10^9}{3 \times 10^8} \times 3 = 10 = k\sqrt{1+8} = 3k \quad \longrightarrow \quad \underline{k = 3.333}$$

$$(c) \quad \lambda = 2\pi/\beta, \quad \lambda_1 = 2\pi/\beta_1 = 2\pi/10 = \underline{0.6283 \text{ m}}$$

$$\beta_2 = \omega/c = 10/3, \quad \lambda_2 = 2\pi/\beta_2 = 2\pi \times 3/10 = \underline{1.885 \text{ m}}$$

$$(d) \quad E_t = \eta_1 a_k x H_t = 40\pi \frac{(a_x + \sqrt{8}a_z)}{3} \times 0.2 \cos(\omega t - k \cdot r) a_y$$

$$\underline{= (-213.3a_x + 75.4a_z) \cos(10^9 t - kx - k\sqrt{8}z) \text{ V/m}}$$

$$(e) \quad \tau_{11} = \frac{2 \cos\theta_i \sin\theta_r}{\sin(\theta_i + \theta_r) \cos(\theta_i - \theta_r)} = \frac{2 \cos 19.47^\circ \sin 90^\circ}{\sin 19.47^\circ \cos 19.47^\circ} = 6$$

$$\Gamma_{11} = -\frac{\cot 19.47^\circ}{\cot 19.47^\circ} = -1$$

$$\text{Let } E_t = -E_{t0} (\cos\theta_i a_x - \sin\theta_i a_z) \cos(10^9 t - \beta_2 x \sin\theta_i - \beta_2 z \cos\theta_i)$$

where

$$E_i = -E_w(\cos\theta_1 a_x - \sin\theta_1 a_z) \cos(10^9 t - \beta_1 x \sin\theta_1 - \beta_1 z \cos\theta_1)$$

$$\sin\theta_1 = 1, \quad \cos\theta_1 = 0, \quad \beta_1 \sin\theta_1 = 10/3$$

$$E_w \sin\theta_1 = \tau_{12} E_w = 6(24\pi)(3)(1) = 1357.2$$

Hence,

$$\underline{E_i = 1357 \cos(10^9 t - 3.333x) a_z} \quad \text{V/m}$$

Since $\Gamma = -1$, $\theta_r = \theta_i$,

$$\underline{E_r = (213.3a_x + 75.4a_z) \cos(10^9 t - kx + k\sqrt{8}z)} \quad \text{V/m}$$

$$(f) \quad \tan\theta_{B//} = \sqrt{\frac{\epsilon_2}{\epsilon_1}} = \sqrt{\frac{\epsilon_o}{9\epsilon_o}} = 1/3 \quad \longrightarrow \quad \underline{\theta_{B//} = 18.43^\circ}$$

Prob. 10.45

$$\beta_1 = \sqrt{3^2 + 4^2} = 5 = \omega / c \quad \longrightarrow \quad \underline{\omega = \beta_1 c = 15 \times 10^8 \text{ rad/s}}$$

Let $E_r = (E_{ox}, E_{oy}, E_{oz}) \sin(\omega t + 3x + 4y)$. In order for

$$\nabla \cdot E_r = 0, \quad 3E_{ox} + 4E_{oy} = 0 \quad (1)$$

Also, at $y=0$, $E_{1tan} = E_{2tan} = 0$

$$E_{1tan} = 0, \quad 8a_x + 5a_z + E_{ox}a_x + E_{oz}a_z = 0$$

Equating components, $E_{ox} = -8$, $E_{oz} = -5$

From (1), $4E_{oy} = -3E_{ox} = 24$ $E_{oy} = 6$

Hence,

$$\underline{E_r = (-8a_x + 6a_y - 5a_z) \sin(15 \times 10^8 t + 3x + 4y)} \quad \text{V/m}$$

Prob. 10.46 Since both media are nonmagnetic,

$$\tan \theta_{B/I} = \sqrt{\frac{\epsilon_2}{\epsilon_1}} = \sqrt{\frac{2.6\epsilon_0}{\epsilon_0}} = 1.612 \quad \longrightarrow \quad \theta_{B/I} = 58.19^\circ$$

But

$$\cos \theta_t = \frac{\eta_1}{\eta_2} \cos \theta_{B/I} = \frac{\eta_0}{\eta_0 / \sqrt{2.6}} \cos \theta_{B/I} = \sqrt{2.6} \cos 58.19^\circ \quad \longrightarrow \quad \underline{\underline{\theta_t = 31.8^\circ}}$$

CHAPTER 11

P.E. 11.1 Since Z_o is real and $\alpha \neq 0$, this is a distortionless line.

$$Z_o = \sqrt{\frac{R}{G}} \quad (1)$$

$$\text{or } \frac{L}{R} = \frac{C}{G} \quad (2)$$

$$\alpha = \sqrt{RG} \quad (3)$$

$$\beta = \omega L \sqrt{\frac{G}{R}} = \frac{\omega L}{Z} \quad (4)$$

$$(1) \times (3) \rightarrow R_o = \alpha Z_o = 0.04 \times 80 = \underline{\underline{3.2 \Omega / \text{m}}},$$

$$(3) \div (1) \rightarrow G = \frac{\alpha}{Z_o} = \frac{0.04}{80} = \underline{\underline{5 \times 10^{-4} \Omega / \text{m}}}$$

$$L = \frac{\beta Z_o}{\omega} = \frac{1.5 \times 80}{2\pi \times 5 \times 10^8} = \underline{\underline{38.2 \text{ nH} / \text{m}}}$$

$$C = \frac{LG}{R} = \frac{12}{\pi} \cdot 10^{-8} \times \frac{0.04}{80} \times \frac{1}{0.04 \times 80} = \underline{\underline{5.97 \text{ pF} / \text{m}}}$$

P.E. 11.2

$$\begin{aligned} \text{(a) } Z_o &= \sqrt{\frac{R + j\omega L}{G + j\omega C}} = \sqrt{\frac{0.03 + j2\pi \times 0.1 \times 10^{-3}}{0 + j2\pi \times 0.02 \times 10^{-6}}} \\ &= 70.73 - j1.688 = \underline{\underline{70.75 \angle -1.367^\circ \Omega}} \end{aligned}$$

$$\begin{aligned} \text{(b) } \gamma &= \sqrt{(R + j\omega L)(G + j\omega C)} = \sqrt{(0.03 + j0.2\pi)(j0.4 \times 10^{-4} \pi)} \\ &= \underline{\underline{2.121 \times 10^{-4} + j8.888 \times 10^{-3} / \text{m}}} \end{aligned}$$

$$\text{(c) } u = \frac{w}{\beta} = \frac{2\pi \times 10^3}{8.888 \times 10^{-3}} = \underline{\underline{7.069 \times 10^5 \text{ m/s}}}$$

P.E. 11.3

$$\text{(a) } Z_o = Z_l \rightarrow Z_m = Z_o = \underline{\underline{30 + j60 \Omega}}$$

$$(b) V_{in} = V_o = \frac{Z_{in}}{Z_{in} + Z_o} V_g = \frac{V_g}{2} = \underline{7.5 \angle 0^\circ \text{ V}_{\text{rms}}}$$

$$I_{in} = I_o = \frac{V_g}{Z_g + Z_{in}} = \frac{V_g}{2Z_o} = \frac{15 \angle 0^\circ}{2(30 + j60^\circ)}$$

$$= \underline{0.05 \angle -63.43^\circ \text{ A}}$$

$$(c) \text{ Since } Z_o = Z_r, \Gamma = 0 \rightarrow V_o^- = 0, V_o^+ = V_o$$

The load voltage is $V_L = V_s(z=l) = V_o^+ e^{-\gamma l}$

$$e^{-\gamma l} = \frac{V_o^+}{V_L} = \frac{7.5 \angle 0^\circ}{5 \angle -48^\circ} = 1.5 \angle 48^\circ$$

$$e^{\alpha l} e^{j\beta l} = 1.5 \angle 48^\circ$$

$$e^{\alpha l} = 1.5 \rightarrow \alpha = \frac{1}{l} \ln(1.5) = \frac{1}{40} \ln(1.5) = 0.0101$$

$$e^{j\beta l} = e^{j48^\circ} \rightarrow \beta = \frac{1}{l} \frac{48^\circ}{180^\circ} \pi \text{ rad} = 0.02094$$

$$\underline{\underline{\gamma = 0.0101 + j0.2094 \text{ / m}}}$$

P.E. 11.4

(a) Using the Smith chart, locate S at $s = 1.6$. Draw a circle of radius OS. Locate P where $\theta_r = 300^\circ$. At P,

$$|\Gamma| = \frac{OP}{OQ} = \frac{2.1 \text{ cm}}{9.2 \text{ cm}} = 0.228$$

$$\underline{\underline{\Gamma = 0.228 \angle 300^\circ}}$$

Also at P, $\underline{\underline{Z_L = 1.15 - j0.48}}$,

$$Z_L = Z_o Z_L = 70(1.15 - j0.48) = \underline{\underline{80.5 - j33.6 \Omega}}$$

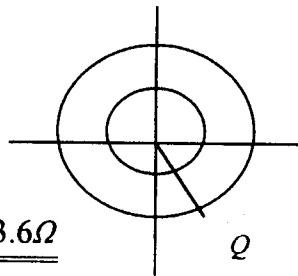

$$l = 0.6\lambda \rightarrow 0.6 \times 720^\circ = 432^\circ = \underline{\underline{360^\circ + 73^\circ}}$$

From P, move 432° to R. At R, $z_{in} = 0.68 - j0.25$

$$Z_{in} = Z_o Z_{in} = 70(0.68 - j0.25) = \underline{\underline{47.6 - j17.5\Omega}}$$

(b) The maximum voltage (the only one) occurs at $\theta_r = 180^\circ$; its distance from the

$$\text{load is } \frac{180 - 60}{720} \lambda = \frac{\lambda}{6} = \underline{\underline{0.1667\lambda}}$$

P.E. 11.5

$$(a) \Gamma = \frac{Z_L - Z_o}{Z_L + Z_o} = \frac{60 + j60 - 60}{60 + j60 + 60} = \frac{j}{2 + j} = \underline{\underline{0.4472 \angle 63.43^\circ}}$$

$$s = \frac{1 + |\Gamma|}{1 - |\Gamma|} = \frac{1 + 0.4472}{1 - 0.4472} = \underline{\underline{2.618}}$$

$$\text{Let } x = \tan(\beta l) = \tan \frac{2\pi l}{\lambda}$$

$$Z_{in} = Z_o \left[\frac{Z_L + jZ_o \tan(\beta l)}{Z_o + jZ_L \tan(\beta l)} \right]$$

$$120 - j60 = 60 \left[\frac{60 + j60 + j60x}{60 + j(60 + j60)x} \right]$$

$$\text{Or } 2 - j = \frac{1 + j(1+x)}{1 - x + jx} \rightarrow 1 - x + j(2x - 2) = 0$$

$$\text{Or } x = 1 = \tan(\beta l)$$

$$\frac{\pi}{4} + n\pi = \frac{2\pi l}{\lambda}$$

$$\text{i.e. } \underline{\underline{l = \frac{\lambda}{8}(1 + 4n), n = 0, 1, 2, 3, \dots}}$$

$$(b) Z_L = \frac{Z_o}{60} \frac{60 + j60}{60} = 1 + j$$

Locate the load point P on the Smith chart.

$$|\Gamma| = \frac{OP}{OQ} = \frac{4.1\text{cm}}{9.2\text{cm}} = 0.4457, \theta_r = 62^\circ$$

$$\Gamma = 0.4457 \angle 62^\circ$$

Locate the point S on the Smith chart. At S, $r = s = 2.6$

$Z_{in} = \frac{Z_{in}}{Z_o} = \frac{120 + j60}{60} = 2 - j$, which is located at R on the chart. The angle between CP

and OR is $64^\circ - (-25^\circ) = 90^\circ$ which is equivalent to $\frac{90\lambda}{720} = \frac{\lambda}{8}$.

Hence $l = \frac{\lambda}{8} + n\frac{\lambda}{2} = \frac{\lambda}{8}(1 + 4n), n = 0, 1, 2, \dots$

$$(Z_{in})_{\max} = sZ_o = 2.618(60) = 157.08\Omega$$

$$(Z_{in})_{\min} = Z_o / s = 60 / 2.618 = \underline{\underline{22.92\Omega}}$$

(does not exist if $n = 0$)

$$l = \frac{62^\circ}{720^\circ} \lambda = 0.0851\lambda$$

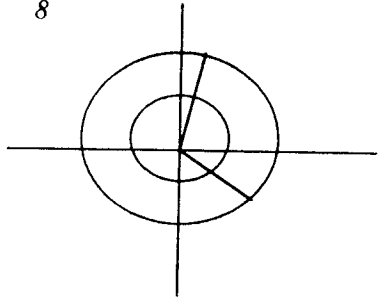

P.E. 11.6

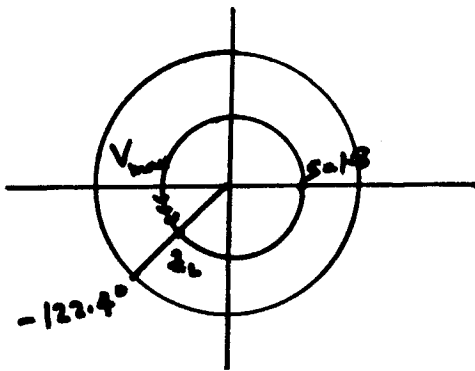

$$\frac{\lambda}{2} = 37.5 - 25 = 12.5\text{cm or } \lambda = 25\text{cm}$$

$$l = 37.5 - 35.5 = 2\text{cm} = \frac{2\lambda}{25}$$

$$l = 0.08\lambda \rightarrow 57.6^\circ$$

$$Z_L = 0.65 - j0.35$$

$$Z_L = Z_o z_L = 50(0.65 - j0.35)$$

$$= \underline{\underline{33.5 - j17.5\Omega}}$$

P.E. 11.7 See the Smith chart

$$Z_L = \frac{100 - j80}{75} = 1.33 - j1.067$$

$$l_A = \frac{132^\circ - 65}{72} \lambda = \underline{\underline{0.093\lambda}}$$

$$l_B = \frac{132^\circ + 64^\circ}{720^\circ} = \underline{\underline{0.272\lambda}}$$

$$d_A = \frac{91}{720} \lambda = 0.126\lambda$$

$$d_B = 0.5\lambda - d_A = \underline{\underline{0.374\lambda}}$$

$$Y_i = \pm \frac{j0.95}{75} = \pm \underline{\underline{j12.67\text{mS}}}$$

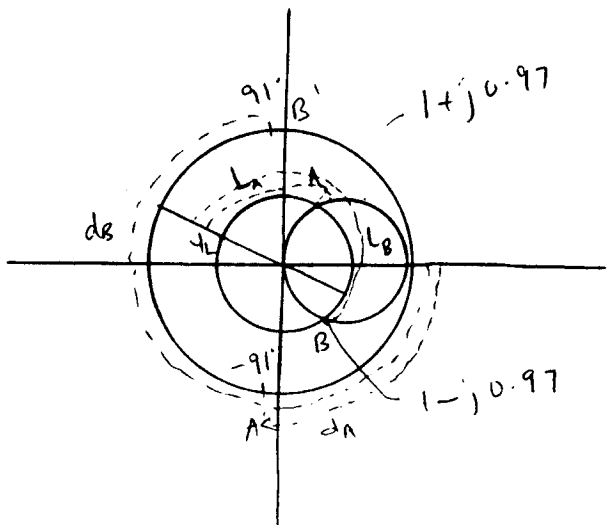

P.E. 11.8

$$(a) \Gamma_G = \frac{1}{3}, \Gamma_L = Z_L \xrightarrow{\text{lim}} 0 \frac{Z_L - Z_o}{Z_L + Z_o} = -1$$

$$V_x = z_L \xrightarrow{\text{lim}} 0 \frac{Z_L}{Z_L + Z_G} V_g = 0, \quad I_x = z_L \xrightarrow{\text{lim}} 0 \frac{V_g}{Z_G + Z_G} = \frac{V_g}{Z_G} = \frac{12}{100} = 120 \text{mA}$$

Thus the bounce diagrams for current and waves are as shown below.

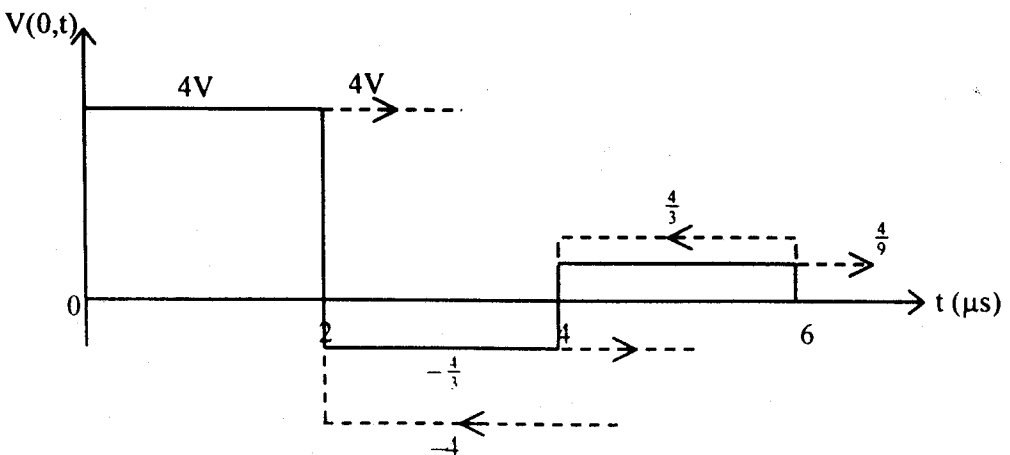
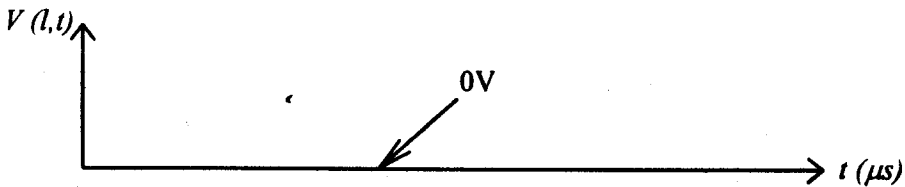
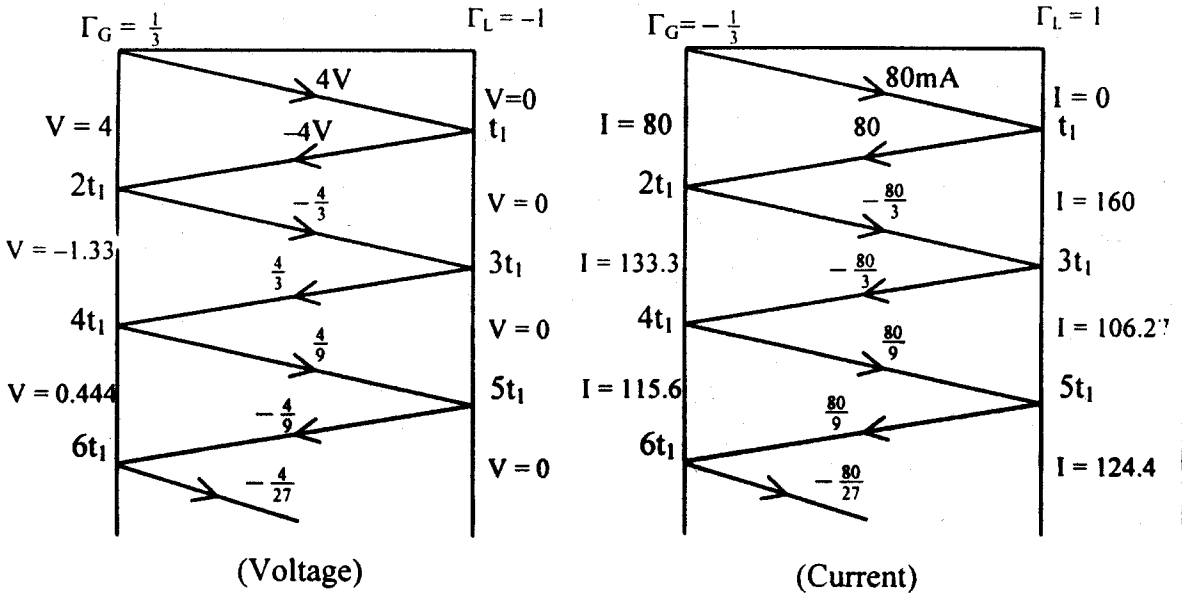

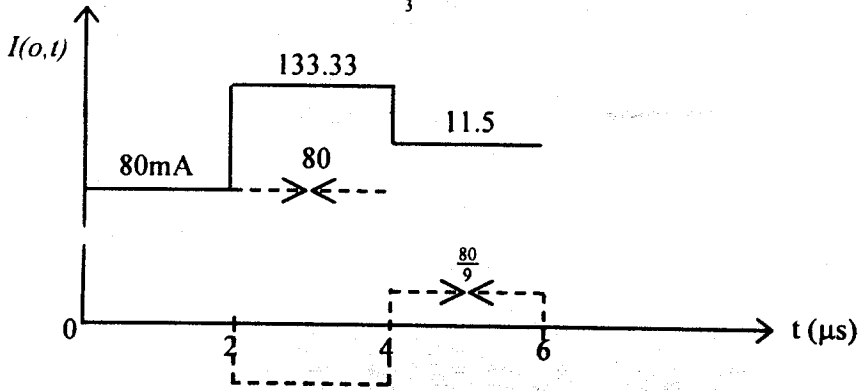
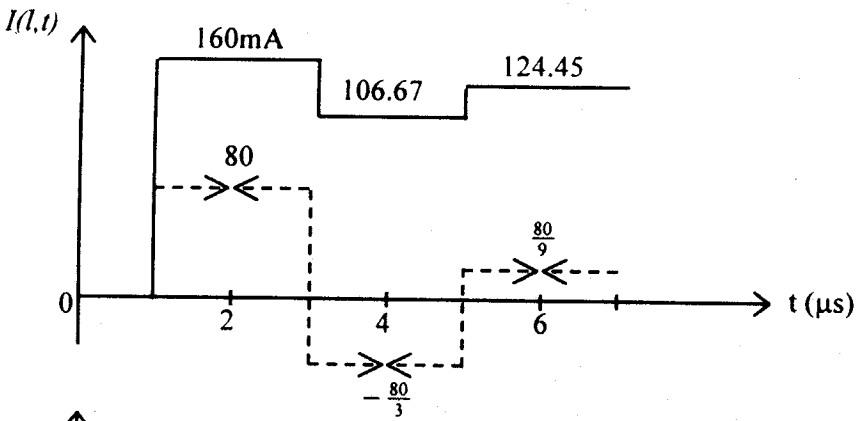

(b) $\Gamma_G = \frac{1}{3}, \Gamma_L = z_L \xrightarrow{\text{lim}} \infty \frac{Z_L - Z_o}{Z_L + Z_o} = 1$

$V_x = z_L \xrightarrow{\text{lim}} \infty \frac{Z_L}{Z_L + Z_g} V_g = V_g = 12V, \quad I_x = z_L \xrightarrow{\text{lim}} \infty \frac{V_g}{Z_L + Z_g} = 0$

The bounce diagrams for current and voltage waves are as shown below.

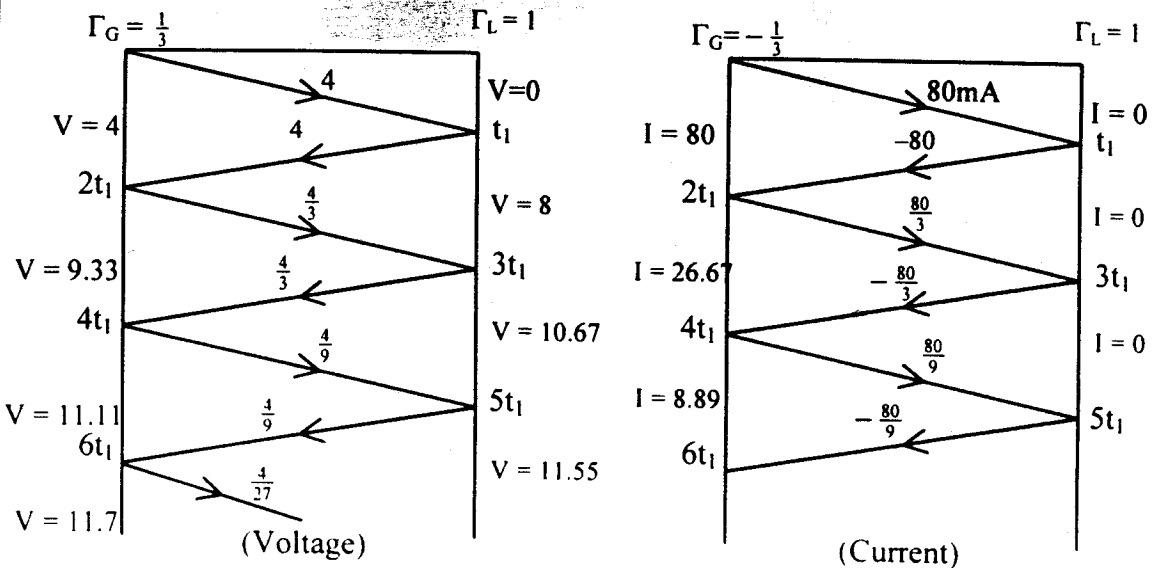

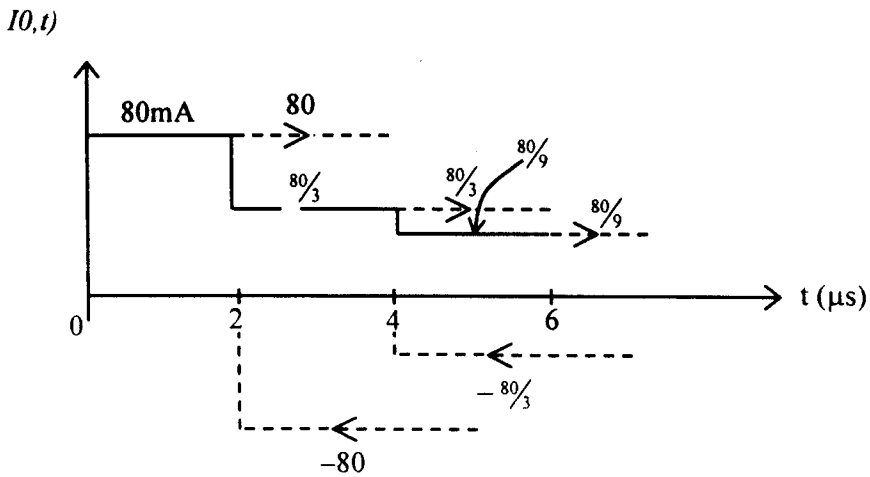
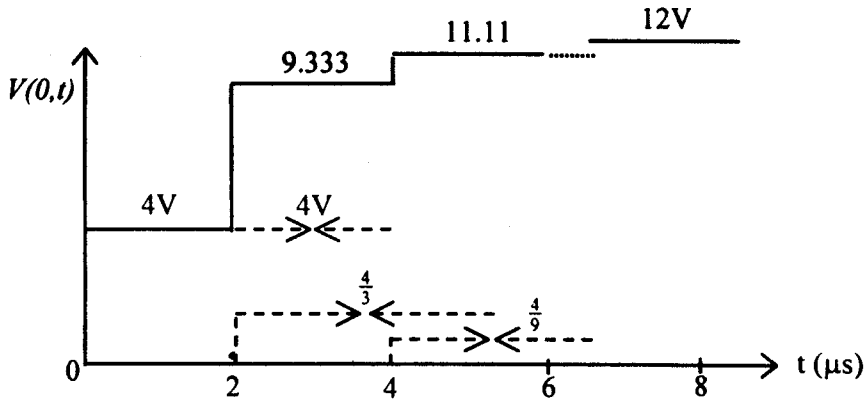
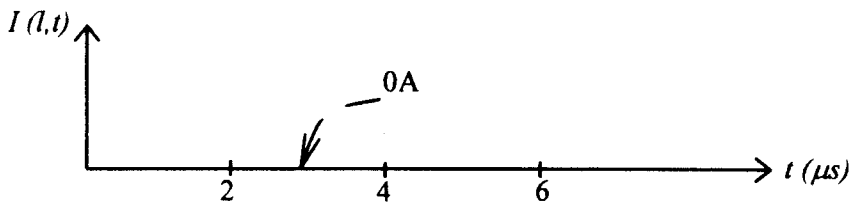
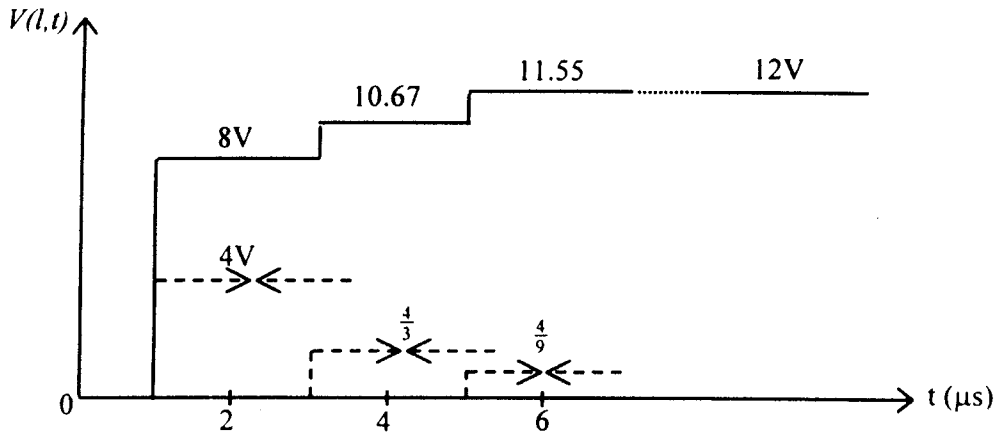

P.E. 11.9

$$\Gamma_a = -\frac{1}{2}, \Gamma_l = \frac{1}{7}, t_l = 2\mu s$$

$$(I_o)_{\max} = \frac{(V_g)_{\max}}{Z_g + Z_o} = \frac{10}{100} = 100mA$$

The bounce diagrams for maximum current are as shown below.

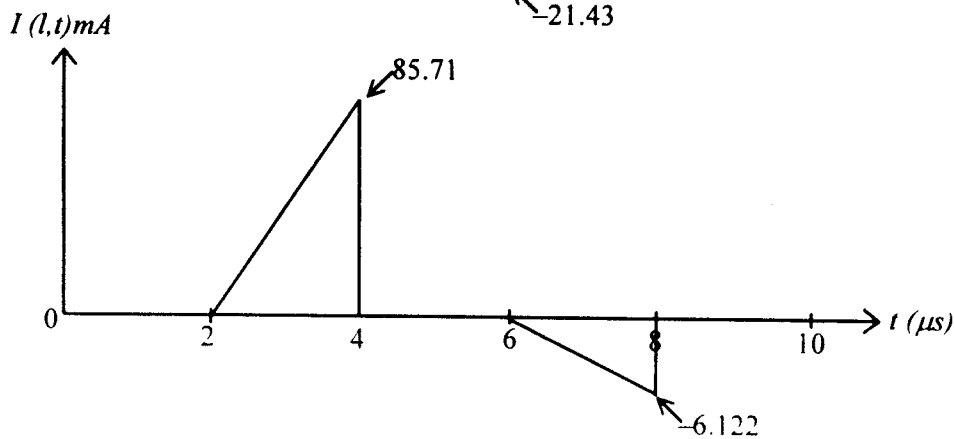
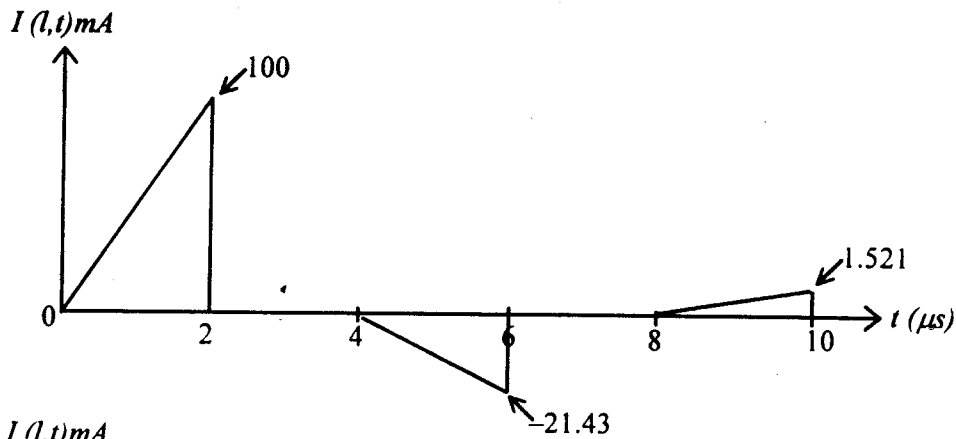
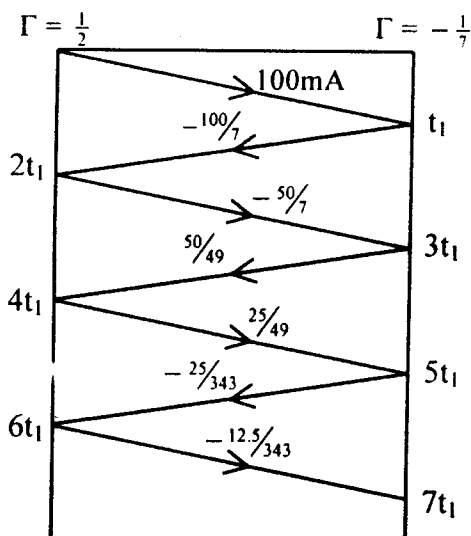

P.E. 11.10

$$(a) \text{ For } w/h = 0.8, \quad \epsilon_{\text{eff}} = \frac{4.8}{2} + \frac{2.8}{2} \left[1 + \frac{12}{0.8} \right]^{-1/2} = \underline{\underline{2.75}}$$

$$(b) Z_o = \frac{60}{\sqrt{2.75}} \ln \left(\frac{8}{0.8} + \frac{0.8}{4} \right) = 36.18 \ln 10.2 = \underline{\underline{84.03 \Omega}}$$

$$(c) \lambda = \frac{3 \times 10^8}{10^{10} \sqrt{2.75}} = \underline{\underline{18.09 \text{ mm}}}$$

P.E. 11.11

$$R_s = \sqrt{\frac{\pi f \mu_o}{\sigma_c}} = \sqrt{\frac{\pi \times 20 \times 10^9 \times 4\pi \times 10^{-7}}{5.8 \times 10^7}}$$

$$= 3.69 \times 10^{-2}$$

$$\alpha_c = 8.685 \frac{R_s}{w Z_o} = \frac{8.686 \times 3.69 \times 10^{-2}}{2.5 \times 10^{-3} \times 50}$$

$$= \underline{\underline{2.564 \text{ dB/m}}}$$

Prob. 11.1

$$\delta = \frac{1}{\sqrt{\pi F \mu \sigma}} = \frac{1}{\sqrt{\pi \times 5 \times 10^7 \times 4\pi \times 10^{-7} \times 6 \times 10^7}}$$

$$\delta = 9.19 \times 10^{-6}$$

$$R = \frac{2}{w \delta \sigma_c} = \frac{2}{0.3 \times 9.19 \times 10^{-6} \times 7 \times 10^7} = \underline{\underline{0.0104 \Omega / \text{m}}}$$

$$L = \frac{\mu_o d}{w} = \frac{4\pi \times 10^{-7} \times 1.2 \times 10^{-2}}{0.3} = \underline{\underline{50.26 \text{ nH/m}}}$$

$$C = \frac{\epsilon_o w}{d} = \frac{10^{-9}}{36\pi} \times \frac{0.3}{1.2 \times 10^{-2}} = \underline{\underline{221 \text{ pF/m}}}$$

Since $\sigma = 0$ for air,

$$G = \frac{\sigma w}{d} = 0$$

Prob. 11.2

$$C = \frac{\pi \epsilon l}{\cosh^{-1}(d/2a)} \cong \frac{\pi \epsilon l}{\ln(d/a)}$$

since $(d/2a)^2 = 11.11 \gg 1$.

$$C = \frac{\pi \times \frac{10^{-9}}{36\pi} \times 16 \times 10^{-3}}{\ln(2/0.3)} = \underline{\underline{0.2342 \text{ pF}}}$$

$$\delta = \frac{l}{\sqrt{\pi f \mu \sigma}} = \frac{l}{\sqrt{\pi \times 10^7 \times 4\pi \times 10^{-7} \times 5.8 \times 10^7}} = 2.09 \times 10^{-5} \text{ m} \ll a$$

$$R_{ac} = \frac{l}{\pi a \delta \sigma} = \frac{16 \times 10^{-3}}{\pi \times 0.3 \times 10^{-3} \times 2.09 \times 10^{-5} \times 5.8 \times 10^7} = \underline{\underline{1.5 \times 10^{-2} \Omega}}$$

Prob. 11.3

(a) Applying Kirchhoff's voltage law to the loop yields

$$V(z + \Delta z, t) + V(z, t) - R\Delta z I_1 - L\Delta z \frac{\partial I_1}{\partial t}$$

$$\text{But } I_1 = I(z, t) - \frac{C}{2} \Delta z \frac{\partial V(z, t)}{\partial t} - \frac{G}{2} \Delta z V(z, t)$$

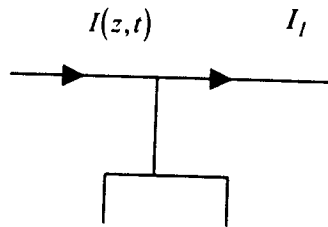

Hence,

$$V(z + \Delta z, t) = V(z, t) - R\Delta z \left[I(z, t) - \frac{C}{2} \Delta z \frac{\partial V}{\partial t} - \frac{G}{2} \Delta z V \right] - L\Delta z \left[\frac{\partial I}{\partial t} - \frac{C}{2} \Delta z \frac{\partial^2 V}{\partial t^2} - \frac{G}{2} \Delta z \frac{\partial V}{\partial t} \right]$$

Dividing by Δz and taking limits as $\Delta z \rightarrow 0$ give

$$\lim_{\Delta z \rightarrow 0} \frac{V(z + \Delta z, t) - V(z, t)}{\Delta z} = \lim_{\Delta z \rightarrow 0} \left[-RI - L \frac{\partial I}{\partial t} + \frac{RC}{2} \Delta z \frac{\partial V}{\partial t} + \frac{RG}{2} \Delta z V + \frac{LC}{2} \Delta z \frac{\partial^2 V}{\partial t^2} + \frac{LC}{2} \Delta z \frac{\partial V}{\partial t} \right]$$

$$\text{or } -\frac{\partial V}{\partial z} = RL + L \frac{\partial I}{\partial t}$$

Similarly, applying Kirchhoff's law to the node leads to

$$I(z + \Delta z, t) = I(z, t) - \frac{R}{2} \Delta z V(z, t) - \frac{C}{2} \Delta z \frac{\partial V}{\partial t} - \frac{G}{2} \Delta z V(z + \Delta z, t) - \frac{G}{2} \Delta z \frac{\partial V(z + \Delta z, t)}{\partial t}$$

$$\lim_{\Delta z \rightarrow 0} \frac{I(z + \Delta z, t) - I(z, t)}{\Delta z} = \lim_{\Delta z \rightarrow 0} \left[-\frac{R}{2} V(z, t) - \frac{C}{2} \frac{\partial V(z, t)}{\partial t} - \frac{G}{2} V(z + \Delta z, t) - \frac{C}{2} \frac{\partial V(z + \Delta z, t)}{\partial t} \right]$$

$$\text{or } -\frac{\partial I}{\partial z} = GV + C \frac{\partial V}{\partial t}$$

(b) Applying Kirchhoff's voltage law,

$$V(z, t) = R \frac{\Delta l}{2} I(z, t) + L \frac{\Delta l}{2} \frac{\partial I}{\partial t}(z, t) + V(z + \Delta l / 2, t)$$

or

$$-\frac{V(z + \Delta l / 2, t) - V(z, t)}{\Delta l / 2} = RI + L \frac{\partial I}{\partial t}$$

$$\text{As } \Delta l \rightarrow 0, \quad -\frac{\partial V}{\partial z} = RI + L \frac{\partial I}{\partial t}$$

Applying Kirchhoff's current law,

$$I(z, t) = I(z + \Delta l, t) + C \Delta l V(z + \Delta l, t) + C \Delta l \frac{\partial V(z + \Delta l / 2, t)}{\partial t}$$

or

$$-\frac{I(z + \Delta l, t) - I(z, t)}{\Delta l} = GV(z + \Delta l, t) + C \frac{\partial V(z + \Delta l, t)}{\partial t}$$

$$\text{As } \Delta l \rightarrow 0, \quad -\frac{\partial I(z, t)}{\partial z} = GV(z, t) + C \frac{\partial V(z, t)}{\partial t}$$

Prob. 11.4

$$Z_o = \sqrt{\frac{L}{C}} = \sqrt{\frac{\mu d}{w} \cdot \frac{d}{\epsilon w}} = \frac{d}{w} \sqrt{\frac{\mu}{\epsilon}}$$

$$Z_o = \eta_o \frac{d}{w} = 78$$

$$Z_o = \eta_o \frac{d}{w} = 75$$

$$\frac{78}{75} = \frac{w}{w} \rightarrow w = 1.04w$$

i.e. the width must be increased by 4%.

Prob. 11.5

$$(a) R + j\omega L = 40 + j2\pi \times 10^7 \times 0.2 \times 10^{-6} = 41.93 \angle 17.44^\circ$$

$$R + j\omega C = 400 \times 10^{-6} + j2\pi \times 10^7 \times 0.5 \times 10^{-9} = 31.42 \times 10^{-2} \angle 89.89^\circ$$

$$Z_o = \sqrt{\frac{R + j\omega L}{G + j\omega C}} = \sqrt{\frac{41.93 \angle 17.44^\circ}{31.42 \times 10^{-2} \angle 89.89^\circ}} = 13.34 \angle -36.24$$

$$\underline{Z_o = 10.76 - j7.886 \Omega}$$

$$\gamma = \sqrt{(R + j\omega L)(G + j\omega L)} = \sqrt{(41.93 \angle 17.44^\circ)(31.42 \times 10^{-2} \angle 89.89^\circ)}$$

$$= 3.6 \angle -53.68^\circ = 2.15 + j2.925 = \alpha + j\beta$$

$$u = \frac{\omega}{\beta} = \frac{2\pi \times 10^7}{2.925} = \underline{\underline{2.148 \times 10^7 \text{ m/s}}}$$

$$(b) \alpha = 2.15 \text{ Np/m} = 2.15 \times 8.686 \text{ dB/m} = 18.675 \text{ dB/m}$$

$$\alpha l = 30 \rightarrow l = \frac{30}{18.675} = \underline{\underline{1.606 \text{ m}}}$$

Prob. 11.6

$$(a) \frac{R}{L} = \frac{G}{C} \rightarrow G = \frac{R}{L} C = \frac{20 \times 63 \times 10^{-12}}{0.3 \times 10^{-6}}$$

$$G = 4.2 \times 10^{-3} \text{ S/m}$$

$$\alpha = \sqrt{RG} = \sqrt{20 \times 4.2 \times 10^{-3}} = 0.2898$$

$$\beta = \omega \sqrt{LC} = 2\pi \times 120 \times 10^6 \sqrt{0.3 \times 10^{-6} \times 63 \times 10^{-12}} = 3.278$$

$$\underline{\underline{\gamma = 0.2898 + j3.278 \text{ /m}}}$$

(b) Let V_o be its original magnitude

$$V_o e^{-\alpha z} = 0.2 V_o \rightarrow e^{-\alpha z} = 5$$

$$z = \frac{l}{\alpha} \ln 5 = \underline{\underline{5.554 \text{ m}}}$$

$$(c) \beta l = 45^\circ = \frac{\pi}{4} \rightarrow l = \frac{\pi}{4\beta} = \frac{4}{4 \times 3.278}$$

$$\underline{\underline{l = 0.2396 \text{ m}}}$$

Prob. 11.7

(a) For a lossless line, $R = 0 = G$.

$$\gamma = j\omega \sqrt{LC} \quad \longrightarrow \quad \beta = \omega \sqrt{LC} = \omega \sqrt{\mu_0 \epsilon_0} = \frac{\omega}{c}$$

$$u = \frac{\omega}{\beta} = \frac{1}{\sqrt{LC}}$$

(b) For lossless line, $R = 0 = G$

$$L = \frac{\mu}{\pi} \cosh^{-1} \frac{d}{2a}, C = \frac{\pi \epsilon}{\cosh^{-1} \frac{d}{2a}}$$

$$Z_0 = \sqrt{\frac{L}{C}} = \sqrt{\frac{\eta}{\pi} \cdot \frac{1}{\pi \epsilon} \cosh^{-1} \frac{d}{2a}} = \frac{120\pi}{\pi \sqrt{\epsilon_r}} \cosh^{-1} \frac{d}{2a}$$

$$\underline{\underline{= \frac{120}{\sqrt{\epsilon_r}} \cosh^{-1} \frac{d}{2a}}}$$

Prob. 11.8

$$L = \frac{\mu}{\pi} \cosh^{-1} \frac{d}{2a} = 4 \times 10^{-7} \cosh^{-1} \frac{0.32}{0.12}$$

$$\underline{\underline{L = 0.655 \mu\text{H/m}}}$$

$$C = \frac{\pi \epsilon}{\cosh^{-1} \frac{d}{2a}} = \frac{\pi \times \frac{10^{-9}}{36\pi} \times 3.5}{\cosh^{-1} 2.667}$$

$$\underline{\underline{C = 59.4 \text{ pF/m}}}$$

$$Z_o = \sqrt{\frac{L}{C}} = \sqrt{\frac{0.655 \times 10^{-6}}{59.4 \times 10^{-12}}} = \underline{\underline{105.8 \Omega}}$$

or

$$Z_o = \frac{120}{\sqrt{3.5}} \cosh^{-1} 2.667 = \underline{\underline{105 \Omega}}$$

Prob. 11.9Since $R = 0 = G$,

$$-\frac{\partial V}{\partial t} = L \frac{\partial I}{\partial t} \quad (1)$$

$$-\frac{\partial I}{\partial t} = C \frac{\partial V}{\partial t} \quad (2)$$

If $V = V_o \sin(\omega t - \beta z)$, from (1)

$$-\frac{\partial I}{\partial t} = V_o \beta \cos(\omega t - \beta z),$$

$$I = \frac{V_o}{L} \beta \cos(\omega t - \beta z)$$

Using (2)

$$\frac{V_o}{wL} \beta^2 \cos(\omega t - \beta z) = wc V_o \cos(\omega t - \beta z)$$

$$\text{i.e. } \frac{\beta^2}{wL} = wc \rightarrow \beta = w\sqrt{Lc}$$

$$\text{But } Z_o = \sqrt{\frac{L}{C}}, \text{ hence } Z_o = \frac{wL}{\beta} \text{ and } \underline{\underline{I_o = \frac{V_o}{Z_o} \sin(\omega t - \beta z)}}$$

Prob. 11.10(a) $\alpha = 0.0025 \text{ Np/m}$, $\beta = 2 \text{ rad/m}$,

$$u = \frac{\omega}{\beta} = \frac{10^8}{2} = \underline{\underline{5 \times 10^7 \text{ m/s}}}$$

$$(b) \Gamma = \frac{V_o}{V_i} = \frac{60}{120} = \frac{1}{2}$$

$$\text{But } \Gamma = \frac{Z_L - Z_o}{Z_L + Z_o} \rightarrow \frac{1}{2} = \frac{300 - Z_o}{300 + Z_o} \rightarrow \underline{\underline{Z_o = 100 \Omega}}$$

$$\begin{aligned}
 I(t) &= \frac{120}{Z_o} e^{0.0025t} \cos(10^8 t + 2t) - \frac{60}{Z_o} e^{-0.0025t} \cos(10^8 t - 2t) \\
 &= \underline{\underline{0.12e^{0.0025t} \cos(10^8 t + 2t) - 0.6e^{-0.0025t} \cos(10^8 t - 2t) A}}
 \end{aligned}$$

Prob. 11.11

$$\begin{aligned}
 \text{(a)} \quad T_L &= \frac{V_L}{V_o^+} = \frac{Z_L I_L}{\frac{1}{2}(V_L + Z_o I_L)} = \frac{2Z_L I_L}{Z_L I_L + Z_o I_L} \\
 &= \underline{\underline{\frac{Z_L I_L}{Z_L + Z_o}}}
 \end{aligned}$$

$$1 + \Gamma_L = 1 + \frac{Z_L - Z_o}{Z_L + Z_o} = \underline{\underline{\frac{2Z_L}{Z_L + Z_o}}}$$

$$\text{(b)} \quad \text{(i)} \quad T_L = \frac{Z_n Z_o}{nZ_o + Z_o} = \frac{Z_n}{Z_n + 1}$$

$$\text{(ii)} \quad T_L = Z_L \xrightarrow{\lim \rightarrow 0} = \frac{2}{1 + Z_o/Z_L} = 2$$

$$\text{(iii)} \quad T_L = Z_L \xrightarrow{\lim \rightarrow 0} = \frac{2Z_L}{Z_L + Z_o} = 0$$

$$\text{(iv)} \quad T_L = \frac{2Z_o}{2Z_o} = 1$$

Prob. 11.12

$$R + j\omega L = 6.5 + j2\pi \times 2 \times 10^6 \times 3.4 \times 10^{-6} = 6.5 + j42.73$$

$$R + j\omega C = 8.4 \times 10^{-3} + j2\pi \times 2 \times 10^6 \times 21.5 \times 10^{-12} = (8.4 + j0.27) \times 10^{-3}$$

$$Z_o = \sqrt{\frac{R + j\omega L}{G + j\omega C}} = \sqrt{\frac{6.5 + j42.73}{(8.4 + j0.27) \times 10^{-3}}}$$

$$Z_o = 71.71 \angle 39.75^\circ = \underline{\underline{55.12 + j45.85 \Omega}}$$

$$\begin{aligned}
 \gamma &= \sqrt{(R + j\omega L)(G + j\omega C)} = \sqrt{(43.19 \angle 81.34^\circ)(8.4 \times 10^{-3} \angle 1.84^\circ)} \\
 &= 0.45 + j0.39/\text{m}
 \end{aligned}$$

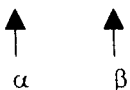

$$t = \frac{l}{u}, \text{ but } u = \frac{w}{\beta},$$

$$t = \frac{\beta l}{\omega} = \frac{0.39 \times 5.6}{2\pi \times 2 \times 10^6} = \underline{\underline{0.1738 \mu s}}$$

Prob. 11.13

$$Z_o = \sqrt{\frac{L}{C}}, \quad \gamma = j\beta = j\omega \sqrt{LC}$$

$$Z_o \beta = \omega L \rightarrow \beta = \frac{\omega L}{Z_o} = \frac{2\pi \times 4.5 \times 10^9 \times 2.4 \times 10^{-6}}{85}$$

$$= \underline{\underline{798.33 \text{ rad/m}}}$$

$$u = \frac{\omega}{\beta} = \frac{Z_o}{L} = \frac{85}{2.4 \times 10^{-6}} = \underline{\underline{3.542 \times 10^7 \text{ m/s}}}$$

Prob. 11.14

$$\Gamma_L = \frac{Z_L - Z_o}{Z_L + Z_o} = \frac{75 + j25 - 50}{75 + j25 + 50} = \underline{\underline{0.2773 \angle 33.69^\circ}}$$

$$s = \frac{1 + |\Gamma|}{1 - |\Gamma|} = \frac{1.2773}{0.7227} = \underline{\underline{1.767}}$$

Prob. 11.15

From eq. (11.33)

$$Z_{sc} = Z_m \Big|_{Z_L=0} = \tanh \gamma l$$

$$Z_{oc} = Z_m \Big|_{Z_L=\infty} = \frac{Z_o}{\tanh \gamma l} = Z_o \coth(\gamma l)$$

For lossless line, $\gamma = j\beta$, $\tan(\gamma l) = \tanh(j\beta l) = j \tan(\beta l)$

$$Z_{sc} = jZ_o \tan(\beta l), Z_{oc} = -jZ_o \cot(\beta l)$$

Prob. 11.16

$$Z_m = Z_{sc} = Z_o \tan \gamma l = Z_o \frac{\sinh(\gamma l)}{\cosh(\gamma l)}$$

$$\text{But } \gamma l = (0.7 + j2.5)(0.8) = 0.56 + j2$$

$$\sinh(x + jy) = \sinh(x) \cos(y) + j \cosh(x) \sin(y)$$

$$= \frac{(e^{0.56} - e^{-0.56})}{2} \cos 2 + j \frac{(e^{0.56} + e^{-0.56})}{2} \sin 2$$

$$= -0.245 + j0.0548$$

$$\cosh(x + jy) = \cosh(x) \cos(y) + j \sinh(x) \sin(y)$$

$$= -0.4831 + j0.5362$$

$$Z_m = \frac{(65 + j38)(-0.2454 + j1.0548)}{-0.4831 + j0.5362}$$

$$= \underline{\underline{113 + j2.726\Omega}}$$

Prob. 11.17

$$(a) \Gamma = \frac{Z_L - Z_o}{Z_L + Z_o} = \frac{120 - 50}{170} = 0.4112$$

$$\Gamma = \frac{1 + |\Gamma|}{1 - |\Gamma|} = 2.397$$

$$(b) Z_m = Z_o \frac{Z_L + jZ_o \tan(\beta l)}{Z_o + jZ_L \tan(\beta l)}$$

$$\beta l = \frac{2\pi}{\lambda} \cdot \frac{\lambda}{6} = 60^\circ$$

$$Z_m = 50 \left[\frac{120 + j50 \tan(60^\circ)}{50 + j120 \tan(60^\circ)} \right] = \underline{\underline{34.63 \angle -40.65^\circ \Omega}}$$

Prob. 11.18

$$Z_L = \frac{Z_L}{Z_0} = \frac{210}{100} = 2.1 = s$$

$$\text{Or } \Gamma = \frac{Z_L - Z_0}{Z_L + Z_0} = \frac{110}{310},$$

$$s = \frac{1 + |\Gamma|}{1 - |\Gamma|} = 2.1$$

$$\text{But } s = \frac{V_{\max}}{V_{\min}} \rightarrow V_{\max} = sV_{\min}$$

$$\text{Since the line is } \frac{\lambda}{4} \text{ long, } \frac{\lambda}{4} \rightarrow \frac{720^\circ}{4} = 180^\circ$$

Hence the sending end will be V_{\min} ,

while the receiving end at V_{\max}

$$V_{\max} = sV_{\min} = 2.1 \times 80 = \underline{\underline{168V}}$$

Prob. 11.19

$$I_L = \frac{V_L}{Z_L}, \Gamma = \frac{Z_L - Z_0}{Z_L + Z_0} = \frac{50e^{j30^\circ} - 50}{50e^{j30^\circ} + 50}$$

$$\approx j0.2679$$

From eq.(11.30),

$$V_o^+ = \frac{1}{2}(V_L + Z_0 \cdot \frac{V_L}{Z_L})e^{\gamma l} = \frac{V_L}{2Z_L}(Z_L + Z_0)e^{\gamma l}$$

$$V_o^- = \frac{V_L}{2Z_L}(Z_L - Z_0)e^{-\gamma l}$$

Substituting these in eq.(11.25),

$$I_s = \frac{V_L}{2Z_L Z_0} [(Z_L + Z_0)e^{\gamma l} e^{-\gamma z} - (Z_L - Z_0)e^{-\gamma l} e^{\gamma z}]$$

$$= \frac{V_L}{1 + \Gamma} [e^{-\gamma(z-l)} - \Gamma e^{\gamma(z-l)}]$$

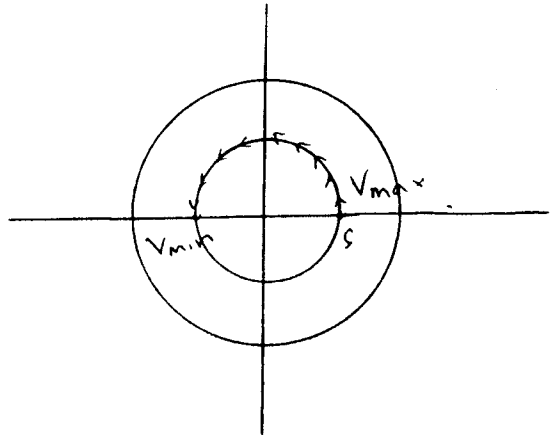

$$\text{But } l - z = \frac{\lambda}{8} \quad \text{or} \quad z - l = -\frac{\lambda}{8}$$

$$\begin{aligned} I_s &= \frac{10\angle 25^\circ}{1.035\angle 15^\circ} \left(\frac{1}{50} \right) \left(e^{j\pi/4} - j0.2679e^{-j\pi/4} \right) \\ &= \underline{\underline{0.2\angle 40^\circ A}} \end{aligned}$$

or

$$\beta z = \frac{2\pi}{\lambda} \cdot \frac{\lambda}{8} = \frac{\pi}{4}, \quad I_L = \frac{V_L}{Z_L} = \frac{10e^{j25^\circ}}{50e^{j30^\circ}} = 0.2e^{-j5^\circ}$$

$$\begin{aligned} I\left(z = \frac{\pi}{8}\right) &= I_L e^{j\beta l} = 0.2e^{-j5^\circ} e^{j45^\circ} \\ &= \underline{\underline{0.2e^{j40^\circ} A}} \end{aligned}$$

Prob. 11.20

$$(a) \quad \beta l = \frac{1}{4} \times 100 = 25 \text{ rad} = 1432.4^\circ = 352.4^\circ$$

$$Z_m = 60 \left[\frac{j40 + j60 \tan 352.4^\circ}{60 - 40 \tan 352.4^\circ} \right] = \underline{\underline{j29.375\Omega}}$$

$$\begin{aligned} V(Z=0) = V_o &= \frac{Z_m}{Z_m + Z_g} V_g = \frac{j29.375(10\angle 0^\circ)}{j29.375 + 50 - j40} \\ &= \frac{29.375\angle 90^\circ}{51.116\angle -12^\circ} = \underline{\underline{0.575\angle 102^\circ}} \end{aligned}$$

$$(b) \quad Z_m = Z_L = \underline{\underline{j40\Omega}}$$

$$V_L = V_s(Z=l), \quad V_o = V_L e^{j\beta l}$$

$$\begin{aligned} V_L &= V_o e^{-j\beta l} = (0.575e^{j102^\circ}) \left(e^{-j352.4^\circ} \right) \\ &= \underline{\underline{0.575\angle -250.4^\circ}} \end{aligned}$$

$$(c) \quad \beta l' = \frac{1}{4} \times 4 = 1 \text{ rad} = 57.3^\circ$$

$$Z_m = 60 \left[\frac{j40 + j60 \tan 57.3^\circ}{60 - 40 \tan 57.3^\circ} \right] = \underline{\underline{-j3487.11 \Omega}}$$

$$V = V_l e^{j\beta l'} = (0.575 \angle -250.4^\circ) e^{j57.3^\circ} \\ = \underline{\underline{0.575 \angle -193.1^\circ}}$$

(d) 3m from the source is the same as 97m from the load., i.e.

$$l' = 100 - 3 = 97 \text{ m}, \quad \beta l' = \frac{1}{4} \times 97 = 24.25 \text{ rad} = 309.42^\circ$$

$$Z_m = 60 \left[\frac{j40 + j60 \tan 309.42^\circ}{60 - 40 \tan 309.42^\circ} \right] = \underline{\underline{-j18.2 \Omega}}$$

$$V = V_l e^{j\beta l'} = (0.575 \angle -250.4^\circ) e^{j309.42^\circ} \\ = \underline{\underline{0.575 \angle 59.02^\circ}}$$

Prob. 11.21

$$\beta l = \frac{2\pi}{\lambda} (1.25\lambda) = \frac{\pi}{2} + 360^\circ,$$

$$\tan \beta l \rightarrow \infty$$

$$Z_m = \frac{Z_o^2}{Z_l} = \underline{\underline{46.875 \Omega}}$$

$$V_o = V(Z=0) = \frac{Z_m}{Z_m + Z_g} V_g = 48.39 \text{ V}.$$

for a loss less line,

$$|V_l| = |V(Z=0)| = \underline{\underline{48.39}}$$

Prob. 11.22

Using the Smith chart, $Z_L = \frac{60 - j35}{100} = 0.6 - j0.35$

At C, $Z_m = Z_L = 60 - j35$

$$Z_L = \frac{60 - j35}{75} = 0.8 - j0.4667$$

$$l = \frac{3\lambda}{4} \rightarrow \frac{3}{4} \times 720^\circ = 540^\circ$$

At B, $Z_m = 75(0.95 + j0.54) = 71.25 + j40.5$

$$Z_L = \frac{71.25 - j40.5}{50} = 1.425 + j0.81$$

$$l = \frac{5\lambda}{8} \rightarrow 450^\circ = 360^\circ + 90^\circ$$

At A, $Z_m = 50(1.4 + j0.81) = \underline{\underline{70 + j40.5\Omega}}$

Prob. 11.23

$$V_1 = V_s(Z=0) = V_o^+ + V_o^- \quad (1)$$

$$V_2 = V_s(Z=l) = V_o^+ e^{-\gamma l} + V_o^- e^{\gamma l} \quad (2)$$

$$I_1 = I_s(Z=0) = \frac{V_o^+}{Z_o} - \frac{V_o^-}{Z_o} \quad (3)$$

$$I_2 = -I_s(Z=l) = -\frac{V_o^+}{Z_o} e^{-\gamma l} + \frac{V_o^-}{Z_o} e^{\gamma l} \quad (4)$$

$$(1) + (3) \rightarrow V_o^+ = \frac{1}{2}(V_1 + Z_o I_1)$$

$$(1) - (3) \rightarrow V_o^- = \frac{1}{2}(V_1 - Z_o I_1)$$

Substituting V_o^+ and V_o^- in (2) gives

$$V_2 = \frac{1}{2}(V_1 + Z_o I_1)e^{-\gamma l} + \frac{1}{2}(V_1 - Z_o I_1)e^{\gamma l}$$

$$= \frac{1}{2}(e^{\gamma l} + e^{-\gamma l})V_1 + \frac{1}{2}Z_o(e^{-\gamma l} - e^{\gamma l})I_1$$

$$V_2 = \cosh \gamma l V_1 + Z_o \sinh \gamma l I_1 \quad (5)$$

Substituting V_o^+ and V_o^- in (4),

$$\begin{aligned} I_2 &= -\frac{1}{2Z_o}(V_1 + Z_o I_1)e^{-\gamma l} + \frac{1}{2Z_o}(V_1 - Z_o I_1)e^{\gamma l} \\ &= \frac{1}{2Z_o}(e^{\gamma l} - e^{-\gamma l})V_1 + \frac{1}{2}(e^{\gamma l} + e^{-\gamma l})I_1 \end{aligned}$$

$$I_2 = -\frac{1}{Z_o} \sinh \gamma l V_1 - \cosh \gamma l I_1 \quad (6)$$

From (5) and (6)

$$\begin{bmatrix} V_2 \\ I_2 \end{bmatrix} = \begin{bmatrix} \cosh \gamma l & Z_o \sinh \gamma l \\ -\frac{1}{Z_o} \sinh \gamma l & -\cosh \gamma l \end{bmatrix} \begin{bmatrix} V_1 \\ I_1 \end{bmatrix}$$

But

$$\begin{bmatrix} \cosh \gamma l & Z_o \sinh \gamma l \\ -\frac{1}{Z_o} \sinh \gamma l & -\cosh \gamma l \end{bmatrix}^{-1} = \begin{bmatrix} \cosh \gamma l & Z_o \sinh \gamma l \\ -\frac{1}{Z_o} \sinh \gamma l & -\cosh \gamma l \end{bmatrix}$$

Thus

$$\begin{bmatrix} V_1 \\ I_1 \end{bmatrix} = \begin{bmatrix} \cosh \gamma l & Z_o \sinh \gamma l \\ \frac{1}{Z_o} \sinh \gamma l & \cosh \gamma l \end{bmatrix} \begin{bmatrix} V_2 \\ -I_2 \end{bmatrix}$$

Prob. 11.24

Method 1: $Z_{in} = \frac{80 - j60}{50} = 1.6 - j1.2$

$$\lambda = \frac{u}{f} = \frac{0.8 \times 3 \times 10^8}{3 \times 10^8} = 0.8m$$

$$l_1 = \frac{4.2}{2}m = 2.1m \rightarrow 720^\circ \times \frac{2.1}{0.8} = 5 \text{ revolutions} + 90^\circ$$

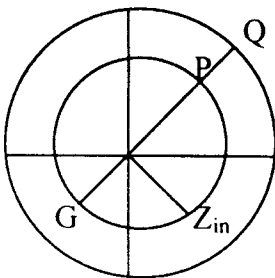

At G, $Z_{in} = 0.44 - j0.4$

$$\begin{aligned} Z_{in} &= Z_{in} Z_o = 50(0.44 - j0.4) \\ &= \underline{\underline{22 - j20\Omega}} \end{aligned}$$

$$|\Gamma| = \frac{OP}{OQ} = \frac{4.3cm}{9.3cm} = 0.4624, \theta_\Gamma = 50.5$$

$$\Gamma = \underline{\underline{0.4624 \angle 50.5^\circ}}$$

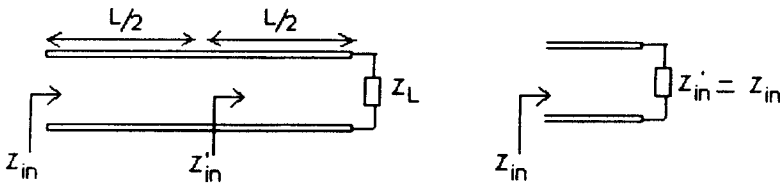

$$\tan \beta l = \tan \frac{\omega l}{u} = \tan \frac{2\pi \times 3 \times 10^8}{0.8 \times 3 \times 10^8} \quad (2.1)$$

$$= \tan \left(21 \times \frac{\pi}{4} \right) = 1$$

$$Z_{in} = Z_o \left[\frac{Z_L + jZ_o \tan \beta l}{Z_o + jZ_L \tan \beta l} \right] = 50 \left[\frac{80 - j60 + j50 \times 1}{50 + j80 - j60 \times 1} \right]$$

$$= 29.6 \angle -43.152^\circ = \underline{\underline{21.6 - j0.2 \Omega}}$$

$$\Gamma' = \frac{Z_L' - Z_o}{Z_L' + Z_o} = \frac{80 - j60 - 50}{80 - j60 + 50} = \frac{3 - j6}{13 - j6} = 0.4685 \angle -38.66^\circ$$

$$|\Gamma| = |\Gamma'| = 0.4685, \text{ but}$$

$$\theta_\Gamma = \theta_{\Gamma'} + 2 \times \frac{\pi}{4} = -38.66^\circ + 90^\circ = 51.34^\circ$$

$$\Gamma = \underline{\underline{0.4685 \angle 51.34^\circ}}$$

Prob. 11.25

$$Z_{in} = \frac{Z_{in}}{Z_o} = \frac{90 + j150}{60} = 1.5 + j2.5$$

$$\lambda = \frac{u}{f} = \frac{3 \times 10^8}{20 \times 10^6} = 15m, \quad l = 10m = \frac{2}{3} \lambda$$

$$\text{If } \lambda \rightarrow 720^\circ, \text{ then } \frac{2}{3} \lambda \rightarrow 480^\circ = 1 \text{ revolution} + 120^\circ$$

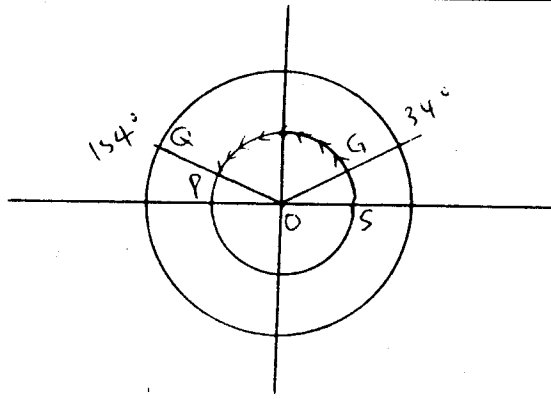

At the Load P, $Z_L = 0.17 + j0.23$

$$Z_i = Z_o Z_L = 60(0.17 + j0.23) = \underline{\underline{10.2 + j13.8\Omega}}$$

$$|\Gamma| = \frac{OP}{OQ} = \frac{6.5 \text{ cm}}{9 \text{ cm}} = 0.7222, \theta = 154^\circ$$

$$\underline{\underline{\Gamma = 0.7222 \angle 154^\circ, s = 6.2}}$$

Prob. 11.26

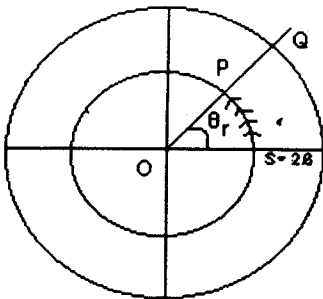

$$(a) \quad Z_m = \frac{Z_m}{Z_o} = \frac{120 + j80}{75} = 1.6 + j1.067$$

$$|\Gamma| = \frac{OP}{OQ} = \frac{3.8 \text{ cm}}{8.7 \text{ cm}} = 0.4367, \quad \theta_\Gamma = 38^\circ$$

$$\Gamma = \underline{0.4367 \angle 38^\circ}, \quad s = \underline{2.6}$$

(b) The Load is purely resistive at s .

$$\theta_\Gamma = 38^\circ$$

$$\text{But } 720^\circ \rightarrow \lambda, \text{ hence } 38^\circ \rightarrow \frac{38\lambda}{720} = \underline{0.053\lambda} \text{ from the load}$$

Prob. 11.27

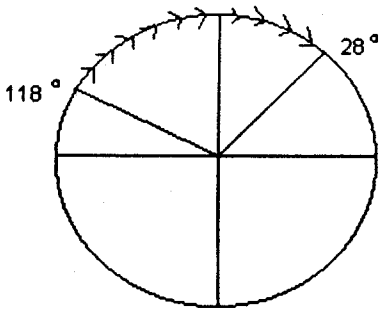

$$(a) \text{ If } \lambda \rightarrow 720^\circ, \text{ then } \frac{5\lambda}{8} \rightarrow \frac{5}{8} \times 720^\circ = 450^\circ \longrightarrow 90^\circ$$

$$z_L = \frac{Z_L}{Z_o} = \frac{j45}{75} = j0.6$$

$$z_m = 0 + j4, \quad Z_m = Z_o Z_m = 75(j4) = \underline{j300\Omega}$$

$$(b) \quad z_L = \frac{25 - j65}{75} = 0.333 - j0.867$$

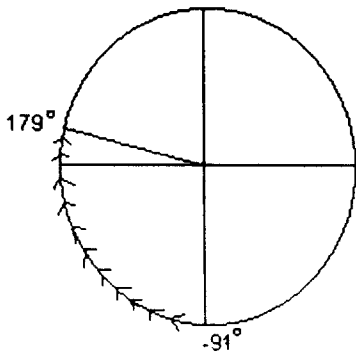

$$z_{in} = 0.2 + j0.01$$

$$Z_{in} = 75(0.2 + j0.01) = \underline{15 + j0.75\Omega}$$

Prob. 11.28

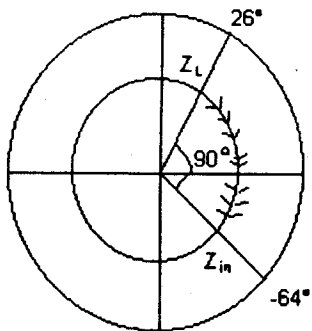

(a) $\lambda \rightarrow 720^\circ$ so then $\frac{\lambda}{8} \rightarrow 90^\circ$

$$z_{in} = \underline{1 - j}$$

(b)

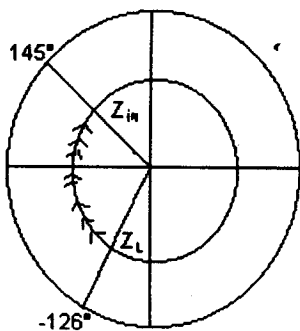

$$z_{in} = 0.18 + j0.31$$

(c)

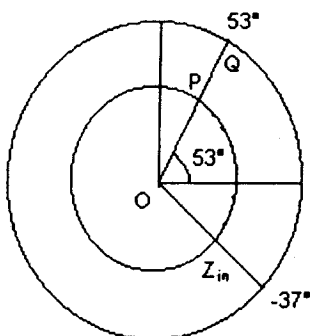

$$\Gamma = 0.3 + j0.4$$

$$= 0.5 \angle 53.13^\circ$$

$$\frac{OP}{OQ} = 0.5$$

$$z_m = \underline{\underline{1.7 + j1.35}}$$

Prob. 11.29

If $\lambda \rightarrow 270^\circ$, then $\frac{\lambda}{6} \rightarrow 120^\circ$

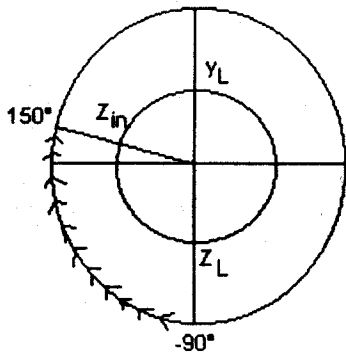

$$z_{in} = \underline{\underline{0.35 + j0.24}}$$

Prob. 11.30

$$(a) \quad Z_m = \frac{Z_m}{Z_o} = \frac{100 - j120}{80} = 1.25 - j1.5$$

$$\lambda = \frac{u}{f} = \frac{0.8 \times 3 \times 10^8}{12 \times 10^6} = 20 \text{ m}$$

$$l_1 = 22 \text{ m} = \frac{22 \lambda}{20} = 1.1 \lambda \rightarrow 720^\circ + 72^\circ$$

$$l_2 = 28 \text{ m} = \frac{28 \lambda}{20} = 1.4 \lambda \rightarrow 720^\circ + 72^\circ + 216^\circ$$

To locate P (the load), we move 2 revolutions plus 72° toward the load. At P,

$$|\Gamma_r| = \frac{OP}{OQ} = \frac{5.1 \text{ cm}}{9.2 \text{ cm}} = 0.5543$$

$$\theta_r = 72^\circ - 47^\circ = 25^\circ$$

$$\Gamma_r = \underline{\underline{0.5543 \angle 25^\circ}}$$

$$Z_{in, \max} = sZ_o = 3.7(80) = \underline{\underline{296 \Omega}}$$

$$Z_{in, \min} = \frac{Z_o}{s} = \frac{80}{3.7} = \underline{\underline{21.622 \Omega}}$$

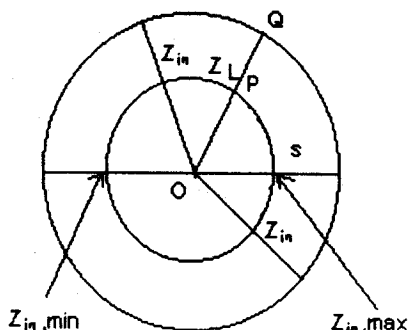

(b) Also, at P, $Z_L = 2.3 + j1.55$

$$Z_L = 80(2.3 + j1.55) = \underline{\underline{184 + j124\Omega}}$$

At S, $s = \underline{\underline{3.7}}$

To Locate Z'_{in} , we move 216° from Z_{in} toward the generator.

At Z'_{in} ,

$$Z'_{in} = 0.48 + j0.76$$

$$Z'_{in} = 80(0.48 + j0.76) = \underline{\underline{38.4 + j60.8\Omega}}$$

(c) Between Z_L and Z_{in} , we move 2 revolutions and 72° . During the movement, we pass through $Z_{in,max}$ 3 times and $Z_{in,min}$ twice.

Thus there are :

$$\underline{\underline{3 Z_{in,max} \text{ and } 2 Z_{in,min}}}$$

Prob. 11.31

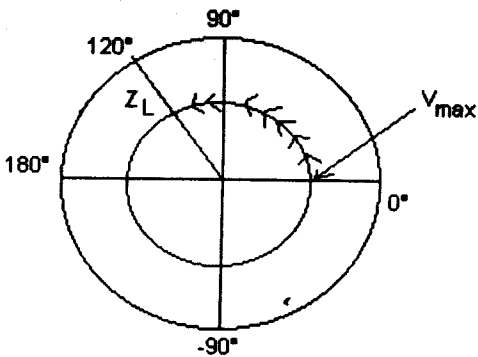

$$(a) \quad \frac{\lambda}{2} = 120cm \rightarrow \lambda = 2.4m$$

$$u = f\lambda \rightarrow f = \frac{u}{\lambda} = \frac{3 \times 10^8}{2.4} = \underline{\underline{125MHz}}$$

$$(b) \quad 40cm = \frac{40\lambda}{240} = \frac{\lambda}{6} \rightarrow \frac{720^\circ}{6} = 120^\circ$$

$$Z_L = Z_o Z_L = 150(0.48 + j0.48) \\ = \underline{\underline{72 + j72}}$$

$$(c) \quad |\Gamma| = \frac{s-1}{s+1} = \frac{1.6}{3.9} = 0.444,$$

$$\Gamma = \underline{\underline{0.444 \angle 120^\circ}}$$

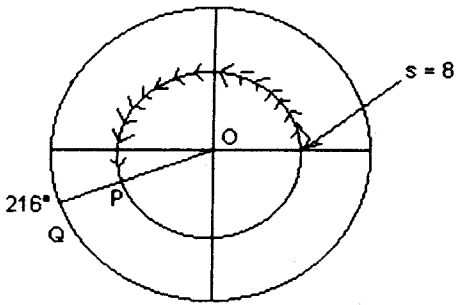
Prob. 11.32

$$0.3\lambda \rightarrow 720^\circ \times 0.3 = 216^\circ$$

$$\text{At P, } Z_L = 0.15 - j0.32$$

$$Z_L = Z_o Z_L = \underline{\underline{15 - j32\Omega}}$$

$$|\Gamma| = \frac{OP}{OQ} = \frac{7.2 \text{ cm}}{9.3 \text{ cm}} = 0.7742$$

$$\Gamma = \underline{\underline{0.7742 \angle 216^\circ}}$$

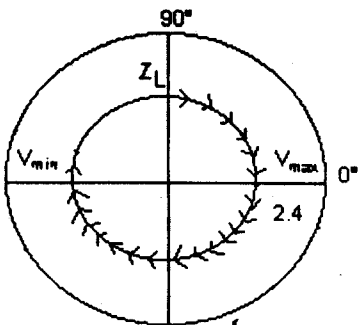
Prob. 11.33

$$(a) \text{ If } \lambda \rightarrow 720^\circ, \text{ then } \frac{\lambda}{8} \rightarrow 90^\circ$$

$$Z_L = 0.7 + j0.68$$

$$Z_L = 50(0.7 + j0.68) = \underline{\underline{35 + j34\Omega}}$$

$$(b) \text{ } l = \frac{\lambda}{4} + \frac{\lambda}{8} = \underline{\underline{0.375\lambda}}$$

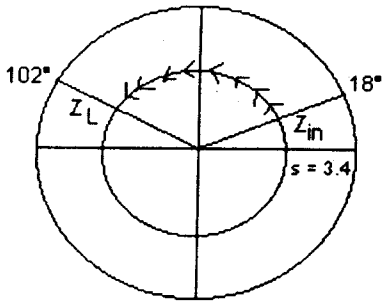
Prob. 11.34

$$l = 0.2\lambda \rightarrow 720^\circ \times 0.2 = 144^\circ$$

$$Z_{in} = \frac{V_s}{I_s} = \frac{2 + j}{10 \times 10^{-3}} = 200 + j100$$

$$Z_{in} = \frac{Z_{in}}{Z_L} = 2.667 + j1.33$$

$$Z_L = 0.3 + j0.12$$

$$Z_L = 75(0.3 + j0.12) = \underline{\underline{22.5 + j9\Omega}}, s = \underline{\underline{3.4}}$$

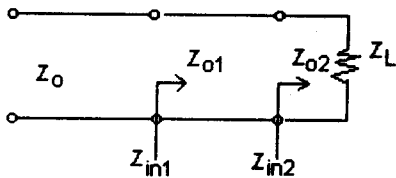
Prob. 11.35

(a) From Eq. (11.43), $Z_{in2} = \frac{Z_{o2}^2}{Z_L}$

$$Z_{in1} = \frac{Z_{o1}^2}{Z_{in2}} = Z_o, \text{ i.e. } Z_{in2} = \frac{Z_{o1}^2}{Z_o} = \frac{Z_{o2}^2}{Z_L}$$

$$Z_{o1} = Z_{o2} \sqrt{\frac{Z_o}{Z_L}} = 30 \sqrt{\frac{50}{75}} = \underline{\underline{24.5\Omega}}$$

(b) Also, $\frac{Z_o}{Z_{o1}} = \left(\frac{Z_{o2}}{Z_L} \right) \rightarrow Z_{o2} = \frac{Z_o Z_L}{Z_{o1}}$ (1)

Also, $\frac{Z_{o1}}{Z_{o2}} = \left(\frac{Z_{o2}}{Z_L} \right)^2 \rightarrow (Z_{o2})^3 = Z_{o1} Z_L^2$ (2)

$$\text{From (1) and (2), } (Z_{o2})^3 = Z_{o1} Z_L^2 = \frac{Z_o^3 Z_L^3}{Z_{o1}^3} \quad (3)$$

$$\text{or } Z_{o1} = \sqrt[4]{Z_o^3 Z_L} = \sqrt[4]{(50)^3 (75)} = \underline{\underline{53.33\Omega}}$$

$$\text{From (3), } Z_{o2} = \sqrt[3]{Z_{o1} Z_L^2} = \sqrt[3]{(53.33)(75)^2} = \underline{\underline{67.74\Omega}}$$

Prob. 11.36

$$\frac{\lambda}{4} \rightarrow 180^\circ, \quad Z_L = \frac{74}{50} = 1.48, \quad \frac{1}{Z_L} = 0.6756$$

This acts as the Load to the left line. But there are two such loads in parallel due to the two lines on the right. Thus

$$Z_L' = 50 \frac{\left(\frac{1}{Z_L}\right)}{2} = 25(0.6756) = 16.892$$

$$Z_L' = \frac{16.892}{50} = 0.3378, \quad Z_{in} = \frac{1}{Z_L'} = 2.96$$

$$Z_{in} = 50(2.96) = \underline{\underline{148\Omega}}$$

Prob. 11.37

From the previous problem, $Z_{in} = 148\Omega$

$$I_{in} = \frac{V_g}{Z_g + Z_{in}} = \frac{120}{80 + 148} = 0.5263 A$$

$$P_{ave} = \frac{1}{2} |I_{in}|^2 R_m = \frac{1}{2} (0.5263)^2 (148) = 20.5W$$

Since the lines are lossless, the average power delivered to either antenna is 10.25W

Prob. 11.38

$$(a) \quad \beta l = \frac{2\pi}{\lambda} \cdot \frac{\lambda}{4} = \frac{\pi}{2}, \quad \tan \beta l = \infty$$

$$Z_m = Z_o \frac{\left(\frac{Z_L + jZ_o \tan \beta l}{Z_o + jZ_L \tan \beta l}\right)}{\left(\frac{Z_o}{\tan \beta l} + jZ_L\right)} = Z_o \frac{\left(\frac{Z_L}{\tan \beta l} + jZ_o\right)}{\left(\frac{Z_o}{\tan \beta l} + jZ_L\right)}$$

As $\tan \beta l \rightarrow \infty$,

$$Z_m = \frac{Z_o^2}{Z_L} = \frac{(50)^2}{100} = \underline{\underline{25\Omega}}$$

(b) If $Z_L = 0$,

$$Z_m = \frac{Z_o^2}{0} = \infty \quad (\text{open})$$

$$(c) \quad Z_L = 25 // \infty = \frac{25 \times \infty}{25 + \infty} = \frac{25}{1 + \frac{25}{\infty}} = 25 \Omega$$

$$Z_m = \frac{(50)^2}{25} = \underline{\underline{100 \Omega}}$$

Prob. 11.39

$$l_1 = \frac{\lambda}{4} \rightarrow Z_{m1} = \frac{Z_o^2}{Z_L} \quad \text{or} \quad y_{m1} = \frac{Z_L}{Z_o}$$

$$y_{m1} = \frac{200 + j150}{(100)^2} = 20 + j15 \text{ mS}$$

$$l_2 = \frac{\lambda}{8} \rightarrow Z_{m2} = Z_L \lim_{Z_o \rightarrow 0} Z_o \left(\frac{Z_L + jZ_o \tan \frac{\pi}{4}}{Z_o + jZ_L \tan \frac{\pi}{4}} \right) = jZ_o$$

$$y_{m2} = \frac{1}{jZ_o} = \frac{1}{j100} = -j10 \text{ mS}$$

$$l_3 = \frac{7\lambda}{8} \rightarrow Z_{m3} = Z_o \frac{\left(Z_i + jZ_o \tan \frac{7\pi}{4} \right)}{\left(Z_o + jZ_i \tan \frac{7\pi}{4} \right)} = \frac{Z_o(Z_i - jZ_o)}{(Z_o - jZ_i)}$$

But

$$y_i = y_{m1} + y_{m2} = 20 + j5 \text{ mS}$$

$$z_i = \frac{1}{y_i} = \frac{1000}{20 + j5} = 47.06 - j11.76$$

$$y_{m3} = \frac{Z_o - jZ_o}{Z_o(Z_i - jZ_o)} = \frac{100 - j47.06 - 11.76}{100(47.06 - j11.76 - j100)} \\ = -6.408 + j5.1890 \text{ mS}$$

If the shorted section were often,

$$y_{m1} = 20 + j15 \text{ mS}$$

$$y_{m2} = \frac{1}{Z_{m2}} = \frac{j \tan \frac{\pi}{4}}{Z_o} = \frac{1}{100} = \underline{\underline{j10 \text{ mS}}}$$

$$l_3 = \frac{7\lambda}{8} \rightarrow Z_{m3} = Z_o \frac{\left(Z_i + jZ_o \tan \frac{7\pi}{4} \right)}{\left(Z_o + jZ_i \tan \frac{7\pi}{4} \right)} = \frac{Z_o (Z_i - jZ_o)}{(Z_o - jZ_i)}$$

$$y_i = y_{m1} + y_{m2} = 20 + j15 + j10 = 20 + j25 \text{ mS}$$

$$Z_i = \frac{1}{y_i} = \frac{1000}{20 + j25} = 19.51 - j24.39 \Omega$$

$$y_{m3} = \frac{Z_o - jZ_i}{Z_o (Z_i - jZ_o)} = \frac{75.61 - j19.51}{100(19.51 - j124.39)}$$

$$= \underline{\underline{2.461 + j5.691 \text{ mS}}}$$

Prob. 11.40

$$z_L = \frac{Z_L}{Z_o} = \frac{60 - j50}{50} = 1.2 - j1$$

$$y_L = \frac{1}{z_L}$$

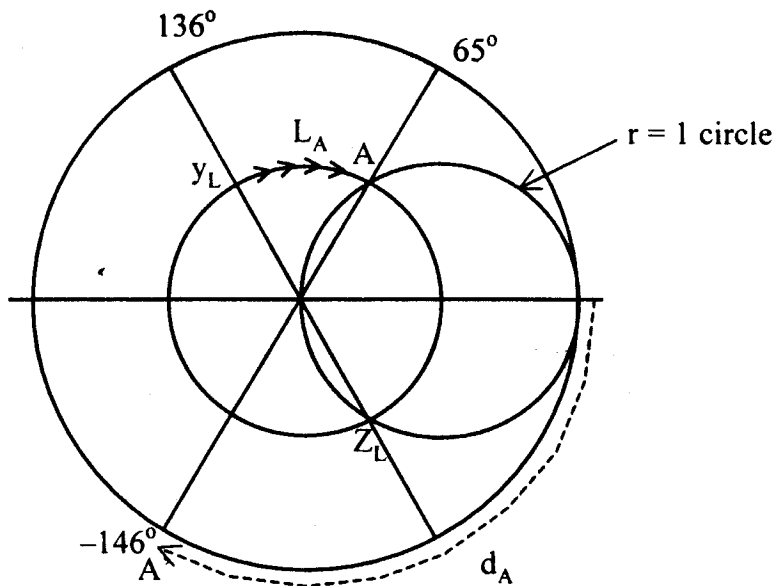

At A, $y = 1 + j0.92$, $y_s = -j0.92$

$$Y_s = Y_o y_s = \frac{-j0.92}{50} = \underline{\underline{-j18.4 \text{ mS}}}$$

$$L_A = (136^\circ - 65^\circ) \frac{\lambda}{720^\circ} = \underline{\underline{0.0986\lambda}}$$

$$d_A = \frac{146^\circ}{720^\circ} = \underline{\underline{0.2028\lambda}}$$

Prob. 11.41

$$d_A = 0.12\lambda \rightarrow 0.12 \times 720^\circ = 86.4^\circ$$

$$l_A = 0.3\lambda \rightarrow 0.3 \times 720^\circ = 216^\circ$$

(a) From the Smith Chart,

$$Z_L = 0.57 + j0.69$$

$$\begin{aligned} Z_L &= 60(0.57 + j0.69) \\ &= \underline{\underline{34.2 + j41.4\Omega}} \end{aligned}$$

$$(b) d_B = \frac{360^\circ - 86.4^\circ}{720^\circ} \lambda = \underline{\underline{0.38\lambda}}$$

$$l_B = \frac{\lambda}{2} - \frac{(-62.4^\circ - -82^\circ)}{720^\circ} \lambda = \underline{\underline{0.473\lambda}}$$

$$(c) \underline{\underline{s = 2.65}}$$

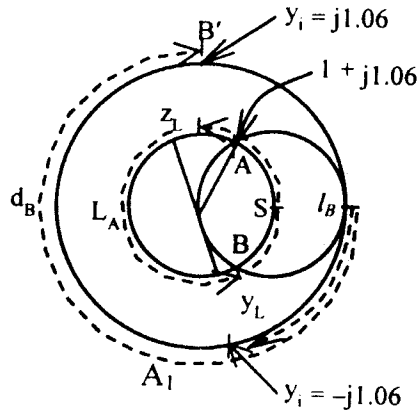
**Prob. 11.42**

$$\frac{\lambda}{4} \rightarrow \frac{720^\circ}{4} = 180^\circ$$

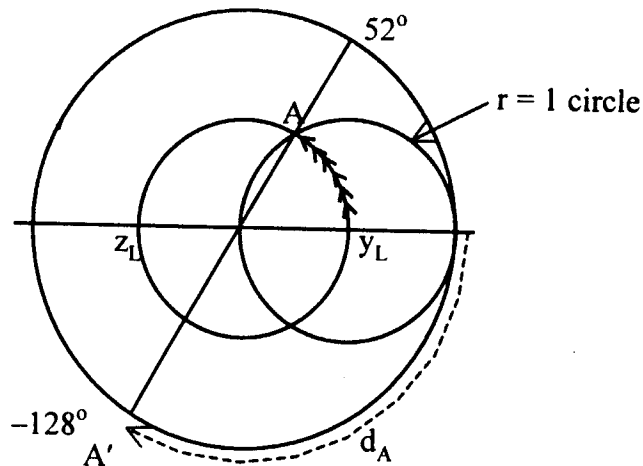

$$\text{At A, } y = 1 + j1.5, y = -j1.5 \rightarrow Y_s = y_s Y_o = -j1.5 Y_o$$

$$d_A = \frac{128^\circ \lambda}{720^\circ} = \underline{\underline{0.1778\lambda}}$$

$$L_A = \frac{52^\circ}{720^\circ} \lambda = \underline{\underline{0.0722\lambda}}$$

Prob. 11.43

$$s = \frac{V_{\max}}{V_{\min}} = \frac{4V}{1V} = 4$$

$$|\Gamma| = \frac{s-1}{s+1} = \frac{3}{3} = 0.6$$

$$\frac{\lambda}{2} = 25 \text{ cm} - 5 \text{ cm} = 20 \text{ cm}$$

$$\rightarrow \lambda = 40 \text{ cm}$$

The load is $l=5\text{cm}$ from V_{\min} , i.e.

$$l = \frac{5\lambda}{40} = \frac{\lambda}{8} \rightarrow 90^\circ$$

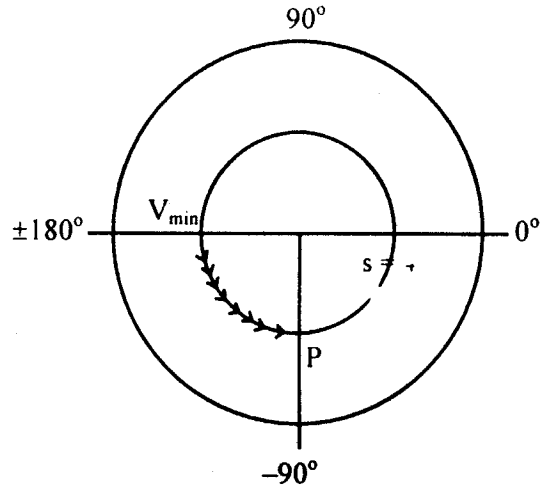

On the $s = 4$ circle, move 90° from V_{\min} towards the load and obtain $Z_L = 0.46 - j0.88$ at

P.

$$Z_L = Z_0 Z_L = 60(0.46 - j0.88) = \underline{\underline{27.6 - j52.8 \Omega}}$$

$$\theta_\Gamma = 270^\circ \text{ or } 90^\circ$$

$$\Gamma = \underline{\underline{0.6 \angle -90^\circ}}$$

Prob. 11.44

$$\frac{\lambda}{2} = 32 - 12 = 20 \text{ cm} \rightarrow \lambda = 40 \text{ cm}$$

$$f = \frac{u}{\lambda} = \frac{3 \times 10^8}{40 \times 10^{-2}} = \underline{\underline{0.75 \text{ GHz}}}$$

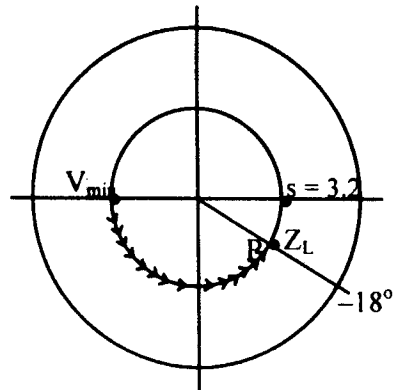

$$l = 21 - 12 = 9 \text{ cm} = \frac{9\lambda}{402} \rightarrow \frac{9}{40} \times 720^\circ = 162^\circ$$

At P, $z_L = 2.6 - j1.2$

$$Z_L = z_L Z_o = 50(2.6 - j1.2) = \underline{\underline{130 - j60\Omega}}$$

Prob. 11.45

$$s = \frac{V_{\max}}{V_{\min}} = \frac{0.95}{0.45} = \underline{\underline{2.11}}$$

$$\frac{\lambda}{2} = 22.5 - 14 = 8.5 \rightarrow \lambda = 17 \text{ cm}$$

$$f = \frac{c}{\lambda} = \frac{3 \times 10^8}{0.17} = \underline{\underline{1.764 \text{ GHz}}}$$

$$l = 3.2 \text{ cm} = \frac{3.2}{17} \lambda \rightarrow 135.5^\circ$$

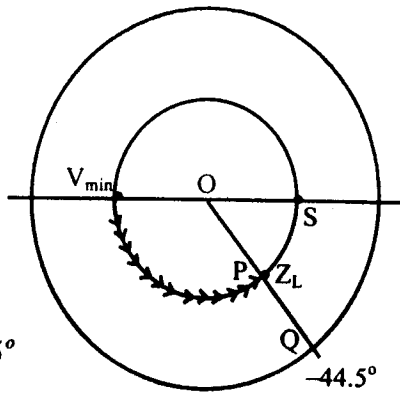
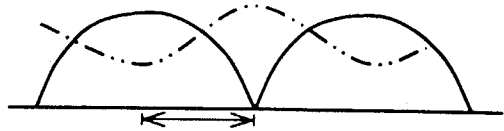

At P, $Z_L = 1.4 - j0.8$

$$Z_L = 50(1.4 - j0.8) = \underline{\underline{70 - j40\Omega}}$$

$$|\Gamma| = \frac{s-1}{s+1} = \frac{1.11}{3.11} = 0.357, \quad \theta_\Gamma = -44.5^\circ$$

$$|\Gamma| = \underline{\underline{0.357 \angle -44.5^\circ}}$$

Prob. 11.46

At $z = 0, t = 0^+, v_o = \frac{Z_o}{Z_o + Z_g} V_g$

$t_1 = \frac{l}{u} =$ transit time or time delay. Hence,

$$V(l, t_1^+)$$

$$V(l, t_1^+) = V_o + \Gamma_L V_o$$

$$V(l, t_1^+) = V_o + \Gamma_L V_o$$

$$V(l, 3t_1^+) = V_o + \Gamma_L V_o + \Gamma_G \Gamma_L V_o$$

$$V(l, 5t_1^+) = V_o + \Gamma_L V_o + \Gamma_G \Gamma_L V_o + \Gamma_G \Gamma_L^2 V_o$$

$$V(l, 7t_1^+) = V_o (1 + \Gamma_L + \Gamma_G \Gamma_L + \Gamma_G \Gamma_L^2 + \Gamma_G^2 \Gamma_L^2)$$

and so on. When $t \gg \frac{l}{u}$

$$V(l, \infty) = V_o \left[1 + \Gamma_G \Gamma_L + (\Gamma_G \Gamma_L)^2 + (\Gamma_G \Gamma_L)^3 + \dots \right] \\ + V_o \Gamma_L \left[1 + \Gamma_G \Gamma_L + (\Gamma_G \Gamma_L)^2 + (\Gamma_G \Gamma_L)^3 + \dots \right]$$

But $1 + x + x^2 + x^3 + \dots = \frac{1}{1-x}$ $|x| < 1$.

Since $|\Gamma_G \Gamma_L| < 1$,

$$V(l, \infty) = V_o \left[\frac{1}{1 - \Gamma_G \Gamma_L} + \frac{\Gamma_L}{1 - \Gamma_G \Gamma_L} \right] = V_o \frac{(1 + \Gamma_L)}{1 - \Gamma_G \Gamma_L} \\ = \frac{Z_o Z_g}{Z_g + Z_o} \left[\frac{1 + \frac{Z_L - Z_o}{Z_L + Z_o}}{1 - \frac{Z_L - Z_o}{Z_L + Z_o} \cdot \frac{Z_g - Z_o}{Z_g + Z_o}} \right] = \frac{V_g Z_L}{Z_L + Z_G}$$

Thus

$$V_\infty = \frac{V_g Z_L}{Z_L + Z_G}, \quad I_\infty = \frac{V_\infty}{Z_L} = \frac{V_g}{Z_L + Z_G}$$

Prob. 11.47

$$t_1 = \frac{l}{u} = \frac{6m}{3 \times 10^8} = 2\mu s, \quad V_o = V_g \cdot \frac{Z_o}{Z_L + Z_g} = 20 \left(\frac{60}{100} \right) = 12V,$$

$$\Gamma_g = \frac{Z_g - Z_o}{Z_g + Z_o} = \frac{40 - 60}{100} = -\frac{1}{5}, \quad \Gamma_L = \frac{Z_L - Z_o}{Z_L + Z_o} = \frac{100 - 60}{160} = \frac{1}{4}.$$

We only need the voltage bounce diagram because we can obtain $I(l, t)$ from $V(l, t)/Z_L$.

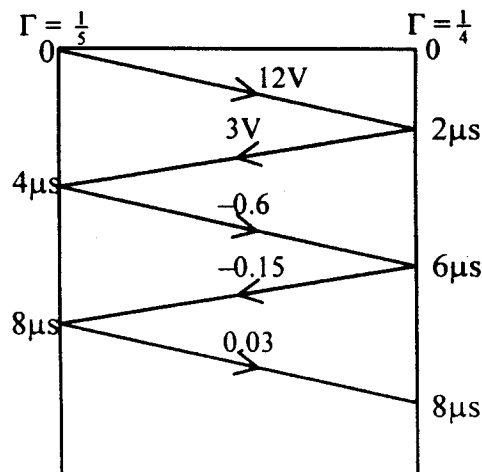

(Voltage bounce diagram)

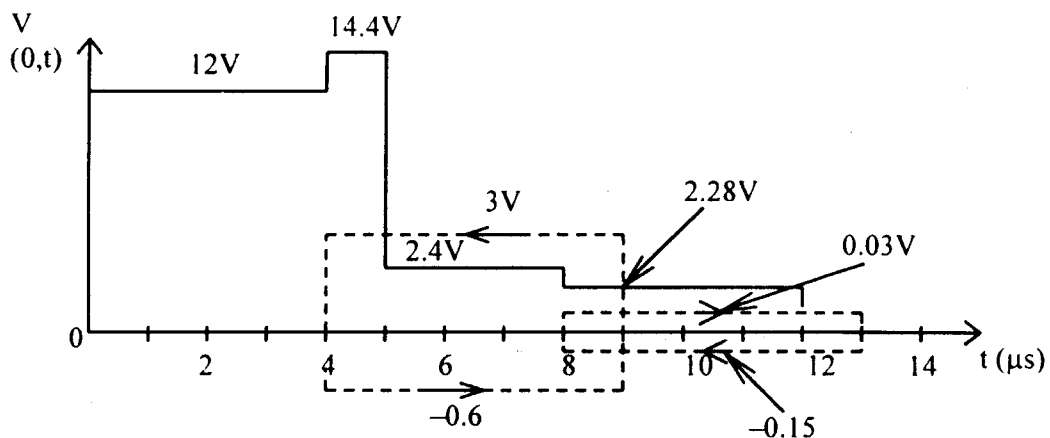

We obtain $V(l,t)$ from the bounce diagram and divide by $Z_L = 100\Omega$ to obtain $I(l,t)$.

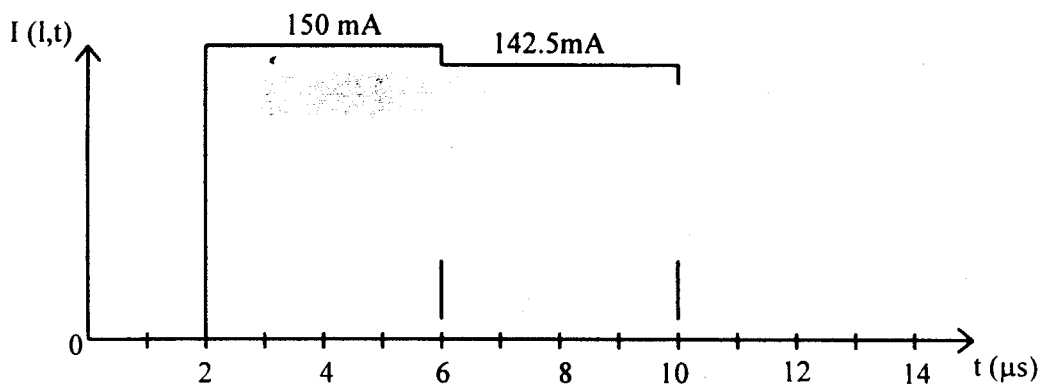
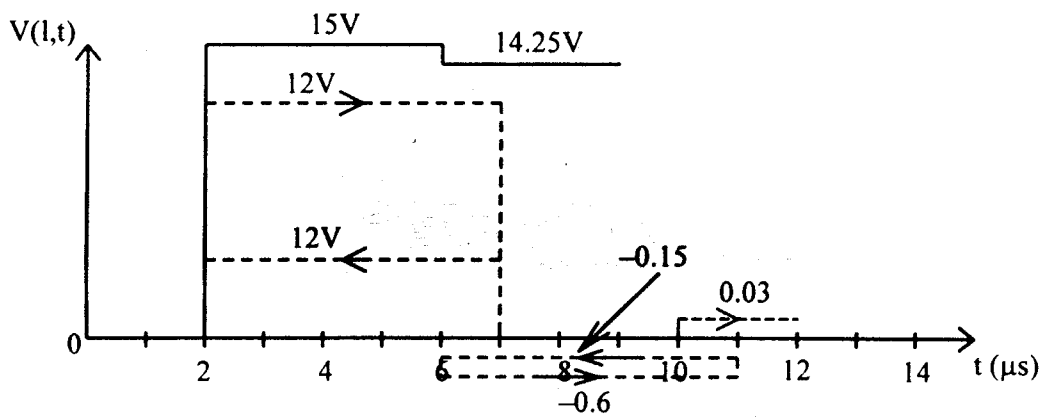

Prob. 11.48

$$\Gamma_L = \frac{Z_L - Z_o}{Z_L + Z_o} = \frac{0.5Z_o - Z_o}{1.5Z_o} = -\frac{1}{3}$$

$$\Gamma_g = \frac{Z_g - Z_o}{Z_g + Z_o} = \frac{Z_o}{3Z_o} = \frac{1}{3}$$

$$t_1 = \frac{l}{u} = 2\mu\text{s}, \quad V_o = \frac{Z_o}{3Z_o}(27) = 9\text{ V}, \quad I_o = \frac{V_o}{Z_o} = 180\text{ mA}$$

$$V_\infty = \frac{Z_L}{Z_g - Z_L} V_g = \frac{0.5}{2.5}(27) = 5.4\text{ V}, \quad I_\infty = \frac{V_\infty}{Z_L} = 216\text{ mA}$$

The voltage and current bounce diagrams are shown below

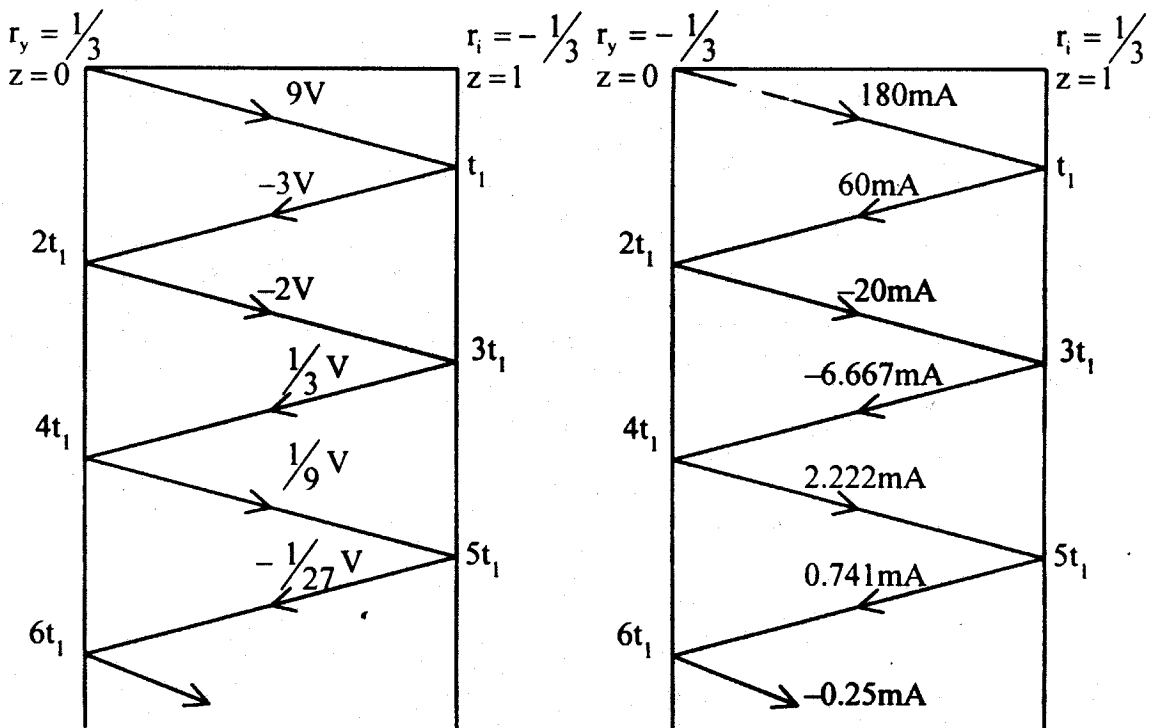

(Voltage bounce diagram)

(Current bounce diagram)

From the bounce diagram, we obtain $V(0,t)$ and $I(0,t)$ as shown below:

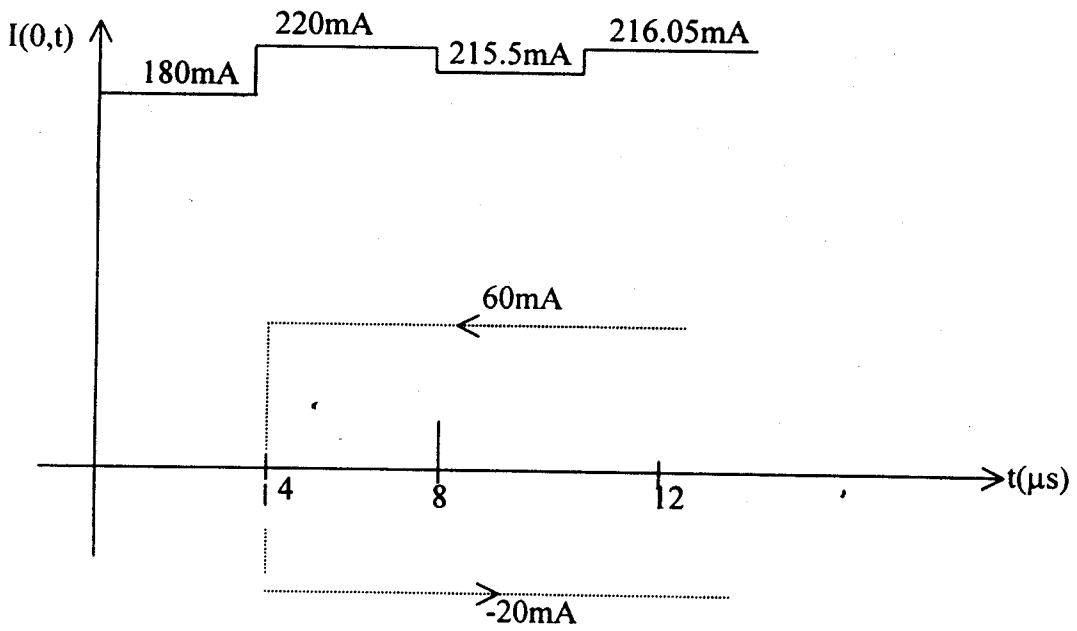
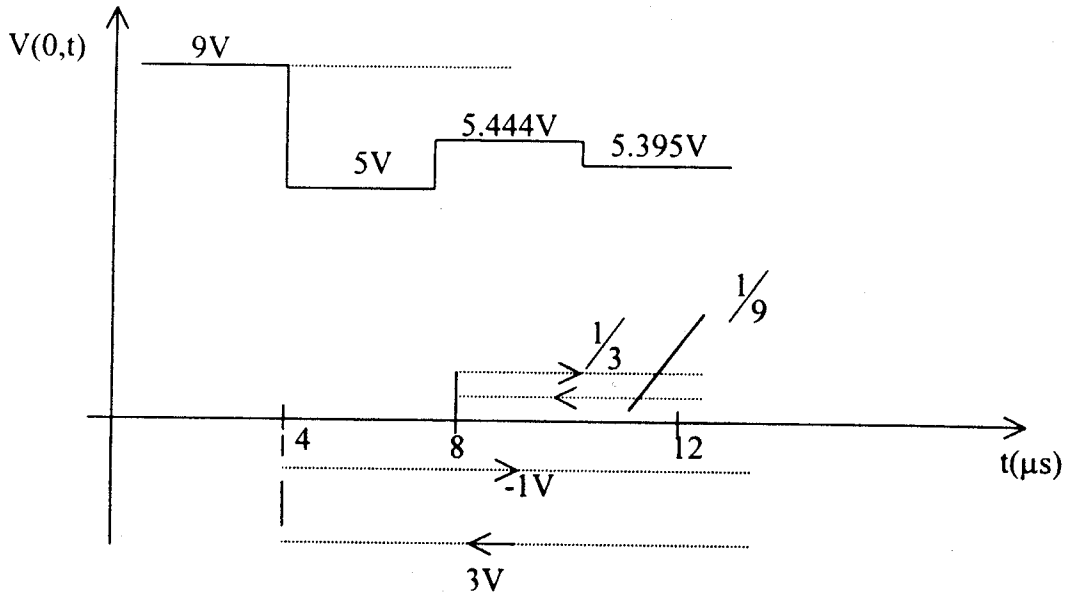

$$\text{[Prob.11.49] } V_0 = \frac{Z_0}{Z_0 + Z_1} V_s = \frac{75}{75 + 54} (100) = 60$$

$$t_1 = \frac{l}{u} = \frac{200}{2 \times 10^8} = 1 \mu\text{s}$$

$$\Gamma_1 = \frac{Z_1 - Z_0}{Z_1 + Z_0} = \frac{50 - 75}{50 + 75} = -\frac{1}{5}, \quad \Gamma_L = \frac{Z_L - Z_0}{Z_L + Z_0} = \frac{150 - 75}{150 + 75} = \frac{1}{3}$$

The voltage bounce diagram is shown below.

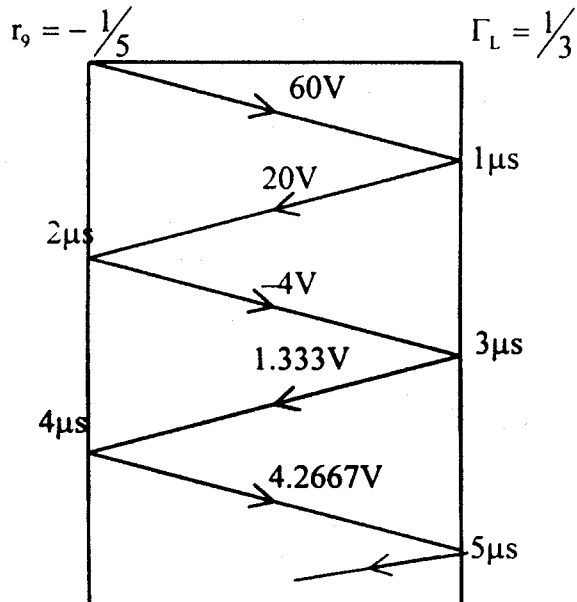

From the bounce diagram, we obtain $V(l,t)$ as shown below.

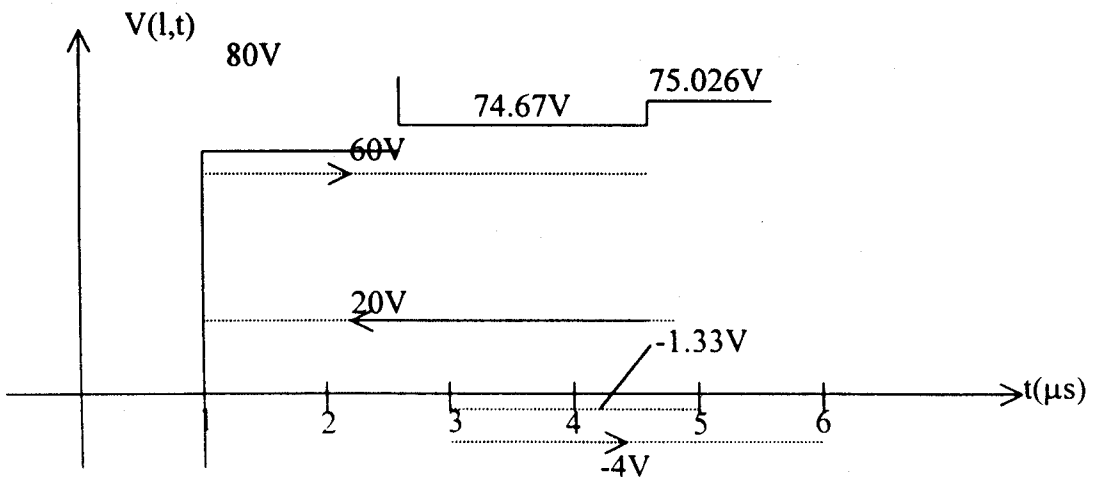

Since

$I(l,t) = \frac{V(l,t)}{150}$, we obtain $I(l,t)$ by scaling $V(l,t)$ down by 150.

The result is shown below.

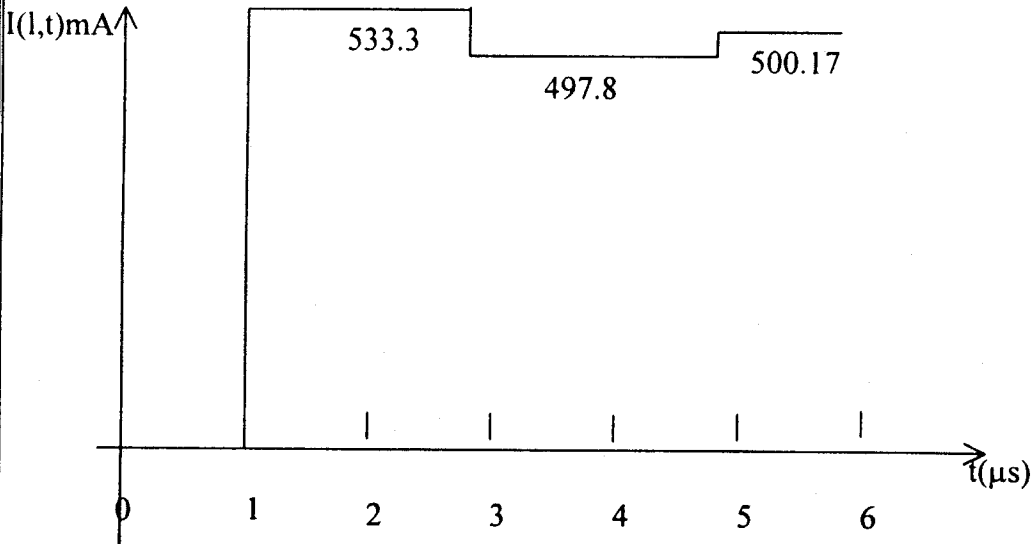

Prob. 11.50

$$(a) \quad t_1 = \frac{l}{u} = \frac{150}{3 \times 10^8} = 0.5 \mu\text{s},$$

$$\Gamma_L = \frac{Z_L - Z_o}{Z_L + Z_o} = \frac{150 - 50}{150 + 150} = \frac{1}{2}, \quad \Gamma_g = \frac{Z_g - Z_o}{Z_g + Z_o} = \frac{25 - 50}{75} = -\frac{1}{3},$$

$$V_o = \frac{Z_o V_g}{Z_o + Z_g} = \frac{50(12)}{75} = 8V, \quad I_o = \frac{V_g}{Z_g + Z_o} = \frac{12}{75} = 160 \text{ mA}$$

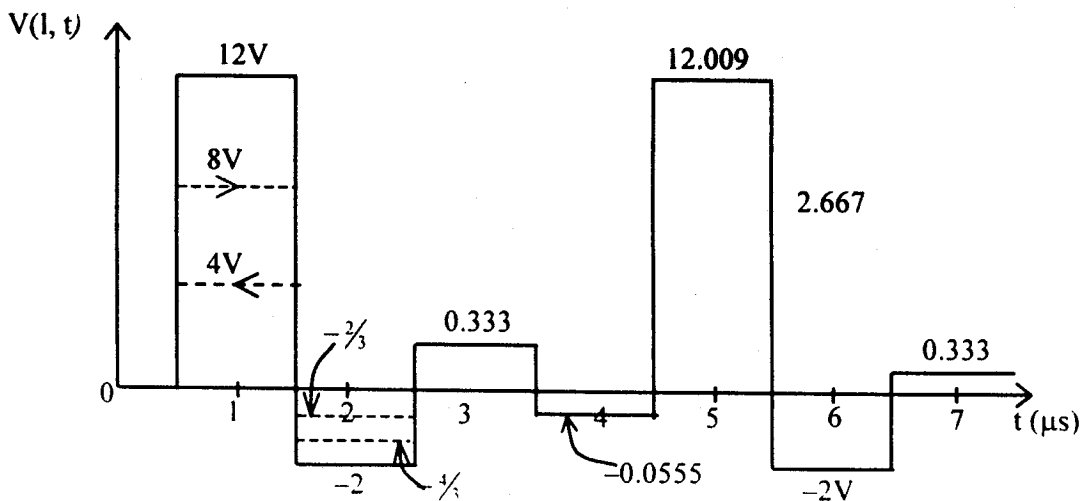
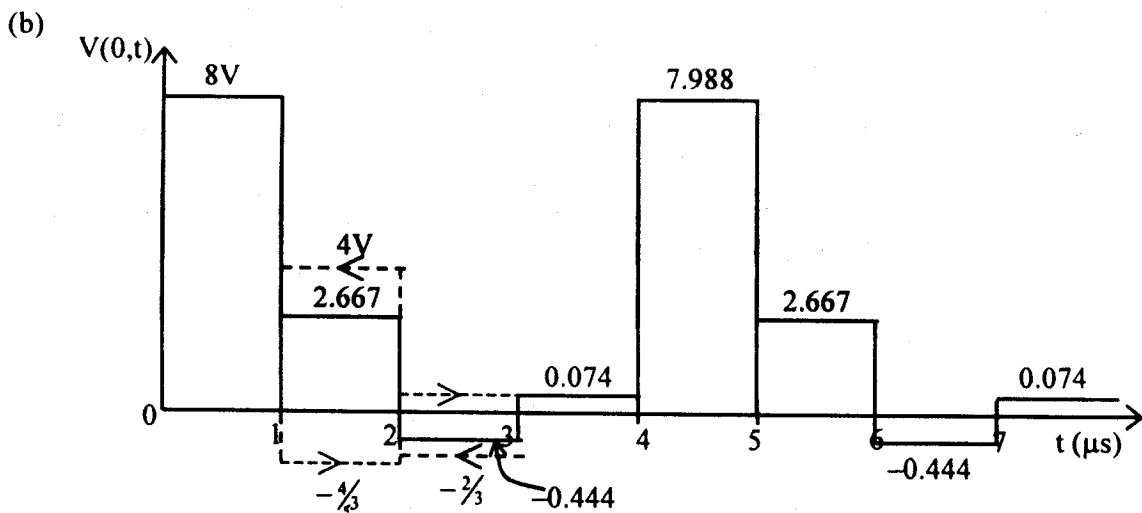
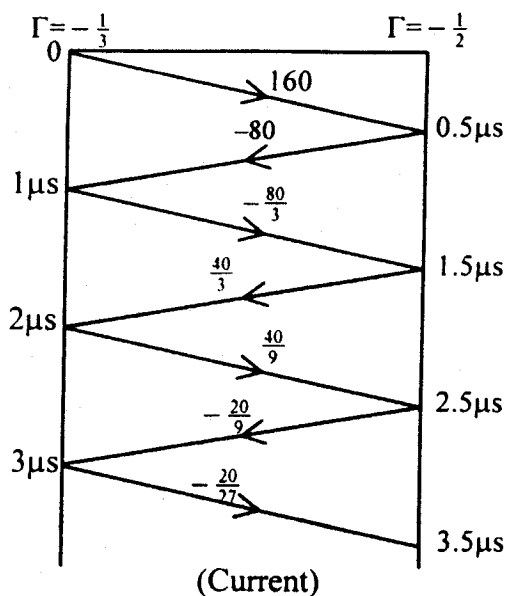
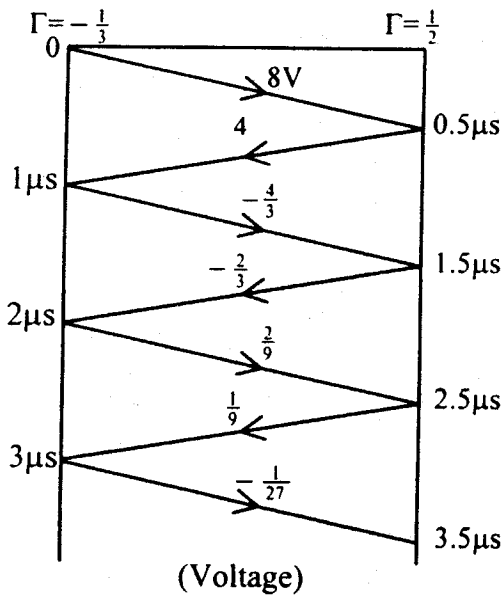

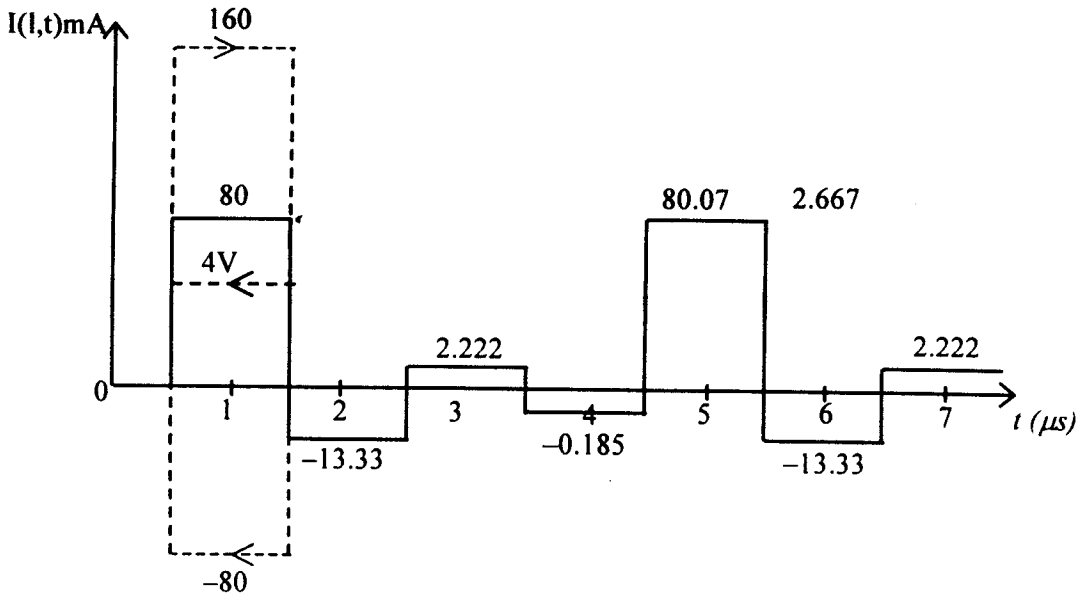
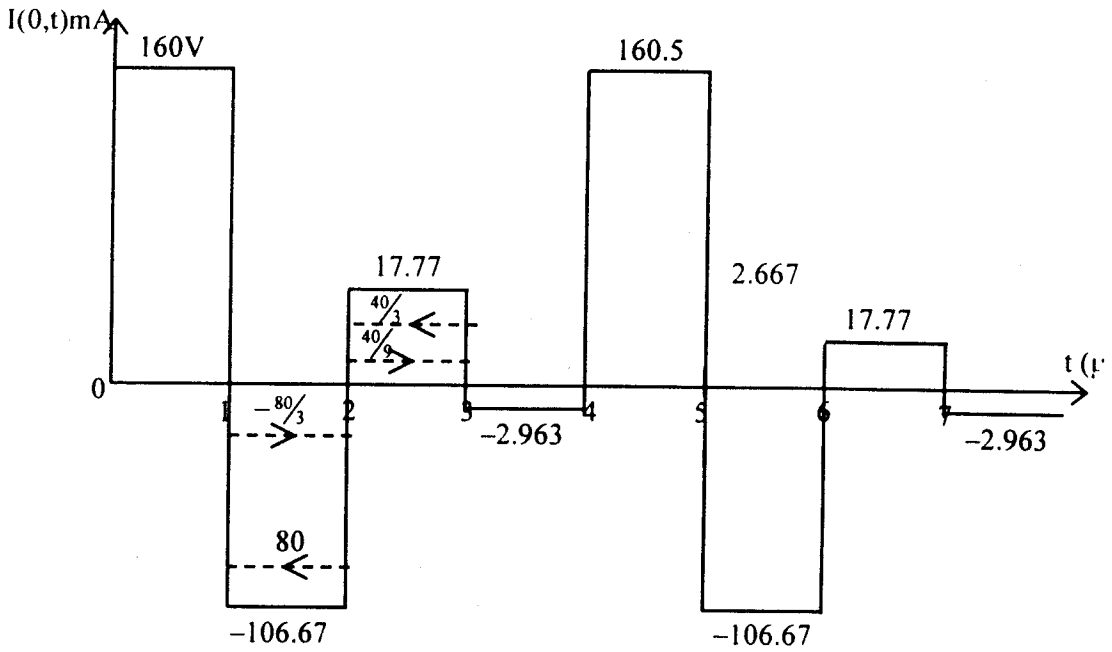

Prob.11.51

$$w = 1.5\text{cm}, h = 1\text{cm}, \frac{w}{h} = 1.5$$

$$(a) \quad \epsilon_{\text{eff}} = \left(\frac{6+1}{2} \right) + \frac{\epsilon_r - 1}{2\sqrt{1+12h/w}} = 1.6 + \frac{0.6}{\sqrt{1+12/1.5}} = 1.8$$

$$\beta_0 = \frac{377}{\sqrt{1.8} (1.5 + 1.393 + 0.667 \ln(2.944))} = \frac{281}{3.613} = 77.77\mu$$

$$(b) \quad \alpha_1 = 8.686 \frac{R_s}{w\beta_0}$$

$$R_s = \frac{1}{\sigma_c \sigma} = \sqrt{\frac{\mu\pi f}{\sigma_c}} = \sqrt{\frac{19 \times 2.5 \times 10^9 \times 4\pi \times 10^{-3}}{1.1 \times 10^7}}$$

$$= 2.995 \times 10^{-2}$$

$$\alpha_1 = \frac{8.686 \times 2.995 \times 10^{-2}}{1.5 \times 10^{-2} \times 77.77} = \underline{0.223 \text{ dB/m}}$$

$$u = \frac{c}{\sqrt{\epsilon_{\text{eff}}}} \rightarrow \lambda = \frac{u}{f} = \frac{c}{f\sqrt{\epsilon_{\text{eff}}}} = \frac{3 \times 10^8}{2.5 \times 10^9 \sqrt{1.8}} = 8.944 \times 10^{-2}$$

$$\alpha_d = 27.3 \times \frac{0.8}{1.2} \frac{(2.2)}{1.8} \frac{2 \times 10^{-2}}{8.944 \times 10^{-2}} = \frac{96.096}{19.319} =$$

$$\alpha_d = \underline{4.974 \text{ dB/m}}$$

$$(c) \quad \alpha = \alpha_1 + \alpha'_d = 5.197 \text{ dB/m}$$

$$\alpha l = 20 \text{ dB} \rightarrow l = \frac{20}{\alpha} = \frac{20}{5.197} = \underline{3.848 \text{ m}}$$

Prob 11.52

(a) Let $x = w/h$. If $x < 1$,

$$50 = \frac{60}{\sqrt{4.6}} \ln\left(\frac{8}{x} + x\right)$$

$$\sqrt[5]{4.6} - 6 \ln\left(\frac{8}{x} + x\right) = 0$$

we solve for x (e.g using Maple) and get $x = 2.027$ or 3.945

which contradicts our assumption that $x < 1$. If $x > 1$,

$$50 = \frac{120\pi}{\sqrt{4.6(x + 1.393 + 0.667 \ln(x + 1.444))}}$$

$$12\pi - 5\sqrt{4.6}(x + 1.393 + 0.667 \ln(x + 1.44))$$

$$\text{solving for } x, \text{ we obtain } x = 1.42 = \frac{w}{h}$$

$$w = 1.42 \times 8 = \underline{\underline{11.36\text{m}}}$$

$$(b) \quad \beta = \frac{\omega \epsilon_{\text{eff}}}{c}$$

$$\beta l = 45^\circ = \frac{\pi}{4} = \frac{w k \epsilon_{\text{eff}}}{c}$$

$$l = \frac{\pi c}{4 \epsilon_{\text{eff}} 2\pi f} = \frac{3 \times 10^8}{8 \times 4.6 \times 8 \times 10^9}$$

$$\underline{\underline{l = 0.102\text{m}}}$$

Prob. 11.53

For $w = 0.4 \text{ mm}$, $\frac{w}{h} = \frac{0.4 \text{ mm}}{2 \text{ m}} = 0.2 \rightarrow$ narrow strip

$$A = \frac{12}{\sqrt{2(9.6+1)}} = 2.606, \quad B = \frac{1}{2} \left(\frac{8.6}{10.6} \right) \left(\ln \frac{\pi}{2} + \frac{1}{9.6} \ln \frac{4}{\pi} \right)$$

$$= 0.4057(0.4516 + 0.02516)$$

$$= 0.1934$$

$$C = \ln \frac{8}{0.2} + \frac{1}{32} (0.2)^2 = 3.69$$

$$Z_o = A(C - B) = 2.606(3.69 - 0.1934) = 9.112\Omega$$

For $w = 8\text{mm}$, $\frac{w}{h} = \frac{8}{2} = 4 \rightarrow$ wide strip.

$$D = \frac{60\pi}{\sqrt{9.6}} = 60.84$$

$$E = 2.0 + 0.4413 + 0.08226 \times \frac{8.6}{(0.6)^2}$$

$$+ \frac{10.6}{2\pi(9.6)} (1.452 + \ln 2.94) = 2.449 + 0.4447$$

$$= 2.8936$$

$$Z_o = \frac{D}{E} = \frac{60.84}{2.8936} = 21.03.$$

Thus,

$$\underline{\underline{9.112\Omega < Z_o < 21.03\Omega}}$$

Prob 11.54

Suppose we guess that $w/h < 2$

$$A = \frac{75}{60} \sqrt{\frac{3.3}{2}} + \frac{1.3}{3.3} \left(0.23 + \frac{0.11}{2.3} \right) = 1.715$$

$$\frac{w}{h} = \frac{8e^A}{e^{2A} - 2} = \frac{44.453}{28.88} = 1.539 \rightarrow w = 1.539h = \underline{\underline{1.85\text{mm}}}$$

If we guess that $w/h > 2$,

$$\frac{60\pi^2}{2\sqrt{\epsilon_r}} = \frac{60\pi^2}{75\sqrt{2.3}} = 3.808$$

$$\frac{w}{h} = \frac{2}{\pi} \left[2.803 - \ln 6.615 + \frac{1.3}{4.6} \left(\ln 2.808 + 0.39 - \frac{0.61}{2.3} \right) \right]$$

$$= 0.793 \neq > 2$$

$$\text{Thus } \frac{w}{h} = 1.539 < 2$$

$$\epsilon_{\text{eff}} = \frac{3.3}{22} + \frac{1.3}{2\sqrt{1 + \frac{12}{1.539}}} = 1.869$$

$$u = \frac{3 \times 10^8}{\sqrt{1.869}} = \underline{\underline{2.194 \times 10^8 \text{ m/s}}}$$

CHAPTER 12

P. E. 12.1 (a) For TE_{10} , $f_c = 3$ GHz,

$$\sqrt{1 - (f_c / f)^2} = \sqrt{1 - (3/15)^2} = \sqrt{0.96}, \quad \beta_o = \omega / u_o = 4\pi f / c$$

$$\beta = \frac{4\pi f}{c} \sqrt{0.96} = \frac{4\pi \times 15 \times 10^9}{3 \times 10^8} \sqrt{0.96} = \underline{\underline{615.6}} \text{ rad/m}$$

$$u = \frac{\omega}{\beta} = \frac{2\pi \times 15 \times 10^9}{615.6} = \underline{\underline{1.531 \times 10^8}} \text{ m/s}$$

$$\eta' = \sqrt{\frac{\mu}{\epsilon}} = 60\pi, \quad \eta_{TE} = \frac{60\pi}{\sqrt{0.96}} = \underline{\underline{192.4\Omega}}$$

(b) For TM_{11} , $f_c = 3\sqrt{7.25}$ GHz, $\sqrt{1 - (f_c / f)^2} = 0.8426$

$$\beta = \frac{4\pi f}{c} (0.8426) = \frac{4\pi \times 15 \times 10^9 (0.8426)}{3 \times 10^8} = \underline{\underline{529.4}} \text{ rad/m}$$

$$u = \frac{\omega}{\beta} = \frac{2\pi \times 15 \times 10^9}{529.4} = \underline{\underline{1.78 \times 10^8}} \text{ m/s}$$

$$\eta_{TM} = 60\pi (0.8426) = \underline{\underline{158.8\Omega}}$$

P. E. 12.2 (a) Since $E_z \neq 0$, this is a TM mode

$$E_{zs} = E_o \sin(m\pi x / a) \sin(n\pi y / b) e^{-j\beta z}$$

$$E_o = 20, \quad \frac{m\pi}{a} = 40\pi \quad \longrightarrow \quad m=2, \quad \frac{n\pi}{b} = 50\pi \quad \longrightarrow \quad n=1$$

i.e. TM_{21} mode.

$$(b) f_c = \frac{u'}{2} \sqrt{(m/a)^2 + (n/b)^2} = \frac{3 \times 10^8}{2} \sqrt{40^2 + 50^2} = 1.5\sqrt{41} \text{ GHz}$$

$$\beta = \omega \sqrt{\mu\epsilon} \sqrt{1 - (f_c / f)^2} = \frac{2\pi f}{c} \sqrt{f^2 - f_c^2} = \frac{2\pi \times 10^9}{3 \times 10^8} \sqrt{225 - 92.25} = \underline{\underline{241.3}} \text{ rad/m.}$$

(c)

$$E_{xy} = \frac{-j\beta}{h^2} (40\pi) 20 \cos 40\pi x \sin 50\pi y e^{-j\beta z}$$

$$E_{yx} = \frac{-j\beta}{h^2} (50\pi) 20 \sin 40\pi x \cos 50\pi y e^{-j\beta z}$$

$$\frac{E_y}{E_x} = \underline{\underline{1.25 \tan 40\pi x \cot 50\pi y}}$$

P. E. 12.3 If TE₁₃ mode is assumed, f_c and β remain the same.

$$\underline{\underline{f_c = 28.57 \text{ GHz}, \beta = 1718.81 \text{ rad/m}, \gamma = j\beta}}$$

$$\eta_{TE13} = \frac{377/2}{\sqrt{1 - (28.57/50)^2}} = \underline{\underline{229.69 \Omega}}$$

For $m=1, n=3$, the field components are:

$$E_z = 0$$

$$H_z = H_o \cos(\pi x / a) \cos(3\pi y / b) \cos(\omega t - \beta z)$$

$$E_x = -\frac{\omega\mu}{h^2} \left(\frac{3\pi}{b} \right) H_o \cos(\pi x / a) \sin(3\pi y / b) \sin(\omega t - \beta z)$$

$$E_y = \frac{\omega\mu}{h^2} \left(\frac{\pi}{a} \right) H_o \sin(\pi x / a) \sin(3\pi y / b) \sin(\omega t - \beta z)$$

$$H_x = -\frac{\beta}{h^2} \left(\frac{\pi}{a} \right) H_o \sin(\pi x / a) \cos(3\pi y / b) \sin(\omega t - \beta z)$$

$$H_y = -\frac{\beta}{h^2} \left(\frac{3\pi}{a} \right) H_o \cos(\pi x / a) \sin(3\pi y / b) \sin(\omega t - \beta z)$$

$$\text{Given that } H_{ox} = 2 = -\frac{\beta}{h^2} (\pi / a) H_o,$$

$$H_{oy} = -\frac{\beta}{h^2} (3\pi / b) H_o = 6a / b = 6(1.5) / 8 = 11.25$$

$$H_{oz} = H_o = -\frac{2h^2 a}{\beta \pi} = \frac{-2 \times 14.51 \pi^2 \times 10^4 \times 1.5 \times 10^{-2}}{1718.81 \pi} = -7.96$$

$$E_{oy} = \frac{\omega\mu}{h^2} \left(\frac{\pi}{a} \right) H_o = -\frac{2\omega\mu}{\beta} = 2\eta_{TE} = -459.4$$

$$E_{ox} = -E_{oy} \frac{3a}{b} = 459.4(4.5 / 0.8) = 2584.1$$

$$E_x = 2584.1 \cos(\pi x / a) \sin(3\pi y / b) \sin(\omega t - \beta z) \text{ V/m,}$$

$$E_y = -459.4 \sin(\pi x / a) \sin(3\pi y / b) \sin(\omega t - \beta z) \text{ V/m,}$$

$$E_z = 0,$$

$$H_y = 11.25 \cos(\pi x / a) \sin(3\pi y / b) \sin(\omega t - \beta z) \text{ A/m,}$$

$$H_z = -7.96 \cos(\pi x / a) \cos(3\pi y / b) \cos(\omega t - \beta z) \text{ A/m}$$

P. E. 12.4

$$f_{\text{c11}} = \frac{u'}{2} \sqrt{\frac{1}{a^2} + \frac{1}{b^2}} = \frac{3 \times 10^8 \times 10^2}{2} \sqrt{1/8.636^2 + 1/4.318^2} = 3.883 \text{ GHz}$$

$$u_p = \frac{3 \times 10^8}{\sqrt{1 - (3.883/4)^2}} = \underline{12.5 \times 10^8} \text{ m/s,}$$

$$u_g = \frac{9 \times 10^{16}}{12.5 \times 10^6} = \underline{7.203 \times 10^7} \text{ m/s}$$

P. E. 12.5 The dominant mode becomes TE₀₁ mode

$$f_{\text{c01}} = \frac{c}{2b} = 3.75 \text{ GHz, } \eta_{\text{TE}} = 406.7\Omega$$

From Example 12.2,

$$E_x = -E_o \sin(3\pi y / b) \sin(\omega t - \beta z), \quad \text{where } E_o = \frac{\omega \mu b}{\pi} H_o.$$

$$\mathcal{P}_{\text{ave}} = \int_{x=0}^a \int_{y=0}^b \frac{|E_x|^2}{2\eta} dx dy = \frac{E_o^2 ab}{4\eta}$$

Hence $E_o = 63.77 \text{ V/m}$ as in Example 12.5.

$$H_o = \frac{\pi E_o}{\omega \mu b} = \frac{\pi \times 63.77}{2\pi \times 10^{10} \times 4\pi \times 10^{-7} \times 4 \times 10^{-2}} = \underline{63.34} \text{ mA/m}$$

P. E. 12.6 (a) For $m=1, n=0, f_c = u'/(2a)$

$$\frac{\sigma}{\omega \epsilon} = \frac{10^{-15}}{2\pi \times 9 \times 10^9 \times 2.6 \times 10^{-9} / (36\pi)} = \frac{10^{-15}}{1.3} \ll 1$$

Hence,

$$u' \cong \frac{1}{\sqrt{\mu \epsilon}} = c / \sqrt{2.6}, \quad f_c = \frac{3 \times 10^8}{2 \times 2.4 \times 10^{-2} \sqrt{2.6}} = 3.876 \text{ GHz}$$

$$\alpha_d = \frac{\sigma \eta'}{2\sqrt{1 - (f_c / f)^2}} = \frac{10^{-15} \times 377 / \sqrt{2.6}}{2\sqrt{1 - (3.876 / 9)^2}} = 1.295 \times 10^{-13} \text{ Np/m}$$

For $n = 0, m = 1,$

$$\alpha_c = \frac{2R_s}{b\eta' \sqrt{1 - (f_c / f)^2}} \left[\frac{1}{2} + \frac{b}{a} (f_c / f)^2 \right]$$

=

$$\frac{2\sqrt{2.6} \sqrt{\pi \times 9 \times 10^9 \times 1.1 \times 10^7 \times 4\pi \times 10^{-7}}}{377 \times 1.5 \times 10^{-2} \times 1.1 \times 10^7 \sqrt{1 - (3.876 / 9)^2}} [0.5 + (2.4 / 1.5)(3.876 / 9)^2] = \underline{\underline{3.148 \times 10^{-2} \text{ Np/m}}}$$

(.) Since $\alpha_c \gg \alpha_d, \alpha = \alpha_c + \alpha_d \cong \alpha_c = 3.148 \times 10^{-2}$

$$\text{loss} = \alpha l = 3.148 \times 10^{-2} \times 0.4 = 1.259 \times 10^{-2} \text{ Np} = \underline{\underline{0.1093 \text{ dB}}}$$

P. E. 12.7 For $\text{TM}_{11}, m = 1 = n,$

$$E_{zs} = E_o \sin(\pi x / a) \sin(\pi y / b) e^{-\gamma z}$$

$$E_{xs} = -\frac{\gamma}{h^2} (\pi / a) E_o \cos(\pi x / a) \sin(\pi y / b) e^{-\gamma z}$$

$$E_{ys} = -\frac{\gamma}{h^2} (\pi / b) E_o \sin(\pi x / a) \cos(\pi y / b) e^{-\gamma z}$$

$$H_{xs} = \frac{j\omega \epsilon}{h^2} (\pi / b) E_o \sin(\pi x / a) \cos(\pi y / b) e^{-\gamma z}$$

$$H_{ys} = -\frac{j\omega \epsilon}{h^2} (\pi / a) E_o \cos(\pi x / a) \sin(\pi y / b) e^{-\gamma z}$$

$$H_{zs} = 0$$

For the electric field lines,

$$\frac{dy}{dx} = \frac{E_y}{E_x} = (a / b) \tan(\pi x / a) \cot(\pi y / b)$$

For the magnetic field lines

$$\frac{dy}{dx} = \frac{H_y}{H_x} = -(a / b) \cot(\pi x / a) \tan(\pi y / b)$$

Notice that $\left(\frac{E_y}{E_x}\right)\left(\frac{H_y}{H_x}\right) = -1$

showing that the electric and magnetic field lines are mutually orthogonal. The field lines are as shown in Fig. 12.14.

P. E. 12.8

$$u' = \frac{l}{\sqrt{\mu\epsilon}} = \frac{c}{\sqrt{\epsilon_r}}$$

$$f_{TE_{101}} = \frac{1.5 \times 10^{10}}{\sqrt{3}} \sqrt{1/25 + 0 + 1/100} = \underline{1.936} \text{ GHz}$$

$$Q_{TE_{101}} = \frac{1}{61\delta}, \text{ where}$$

$$\delta = \frac{1}{\sqrt{\pi f_{101} \mu \sigma_c}} = \frac{1}{\sqrt{\pi \times 1.936 \times 10^9 \times 4\pi \times 10^{-7} \times 5.8 \times 10^7}} = 1.5 \times 10^{-6}$$

$$Q_{TE_{101}} = \frac{10^6}{61 \times 1.5} = \underline{10,929}$$

Prob. 12.1 (a) For TM_{mn} modes, $H_z = 0$

$$E_{zs} = E_o \sin(\pi x / a) \sin(\pi y / b) e^{-\gamma z}$$

Using eq. (12.15), all field components vanish for TM_{01} and TM_{10} .

(b) See text.

Prob. 12.2 (a)

$$f_c = \frac{u'}{2} \sqrt{1/a^2 + 1/b^2} = \frac{3 \times 10^8}{2\sqrt{4 \times 10^{-2}}} \sqrt{1/2^2 + 1/3^2} = \underline{4.507} \text{ GHz}$$

(b)

$$\begin{aligned} \beta &= \beta' \sqrt{1 - (f_c / f)^2} = \frac{\omega}{u'} \sqrt{1 - (f_c / f)^2} = \frac{2\pi \times 20 \times 10^9 \sqrt{4}}{3 \times 10^8} \sqrt{1 - (4.508 / 20)^2} \\ &= 816.2 \text{ rad/m} \end{aligned}$$

(c)

$$u = \omega / \beta = \frac{2\pi \times 20 \times 10^9}{816.21} = \underline{1.54 \times 10^8} \text{ m/s}$$

Prob. 12.3 (a)

$$f_c = \frac{u'}{2} \sqrt{(m/a)^2 + (n/b)^2} = \frac{3 \times 10^8}{2 \times 9 \times 10^{-2}} \sqrt{(m/1)^2 + (n/2)^2} = \frac{15}{18} \sqrt{4m^2 + n^2} \text{ GHz}$$

Mode	F_c (GHz)
TE ₀₁	0.8333
TE ₁₀ , TE ₀₂	1.667
TE ₁₁ , TM ₁₁	1.863
TE ₁₂ , TM ₁₃	2.357
TE ₀₃	2.5
TE ₁₃ , TM ₁₃	3
TE ₀₄	3.333
TE ₁₄ , TM ₁₄	3.727
TE ₀₅ , TE ₂₃ , TM ₂₃	4.167
TE ₁₅ , TM ₁₅	4.488

(b) The highest possible mode is TE₁₅ or TM₁₅.

$$\eta' = \frac{120\pi}{9} = 41.89, \quad \sqrt{1 - (f_c/f)^2} = \sqrt{1 - (4.488/4.5)^2} = 0.073$$

$$\eta_{TE15} = \frac{\eta'}{\sqrt{1 - (f_c/f)^2}} = \frac{41.89}{0.073} = \underline{573.8\Omega}$$

$$\eta_{TM15} = \eta' \sqrt{1 - (f_c/f)^2} = \underline{3.058\Omega}$$

(c) The lowest mode is TE₀₁

$$u' = c/9, \quad u_g = u' \sqrt{1 - (f_c/f)^2} = \frac{3 \times 10^9}{9} \sqrt{1 - (0.8333/4.5)^2} = 3.276 \times 10^8 \text{ m/s}$$

Prob. 12.4 $a/b = 3 \longrightarrow a = 3b$

$$f_{c10} = \frac{u'}{2a} \longrightarrow a = \frac{u'}{2f_{c10}} = \frac{3 \times 10^8}{2 \times 18 \times 10^9} \text{ m} = 0.833 \text{ cm}$$

A design could be $a = 9 \text{ mm}$, $b = 3 \text{ mm}$.

Prob. 12.5 For the dominant mode,

$$f_c = \frac{c}{2a} = \frac{3 \times 10^8}{2 \times 8} = 18.75 \text{ MHz}$$

(a) It will not pass the AM signal, (b) it will pass the FM signal.

Prob. 12.6 (a) For TE₁₀ mode, $f_c = \frac{u'}{2a}$

$$\text{Or } a = \frac{u'}{2f_{c10}} = \frac{3 \times 10^8}{2 \times 5 \times 10^9} = \underline{\underline{3 \text{ cm}}}$$

For TE₀₁ mode, $f_c = \frac{u'}{2b}$

$$\text{Or } b = \frac{u'}{2f_c} = \frac{3 \times 10^8}{2 \times 12 \times 10^9} = \underline{\underline{1.25 \text{ cm}}}$$

(b) Since $a > b$, $1/a < 1/b$, the next higher modes are calculated as shown below.

Mode	f_c (GHz)
TE ₁₀	5
*TE ₂₀	10
TE ₃₀	15
TE ₄₀	20
*TE ₀₁	12
TE ₀₂	24
*TE ₁₁	13
TE ₂₁	15.62

The next three higher modes are starred ones, i.e. TE₂₀, TE₀₁, TE₁₁

$$(c) u' = \frac{1}{\sqrt{\mu\epsilon}} = \frac{c}{\sqrt{2.25}} = 2 \times 10^8 \text{ m/s}$$

For TE₁₁ modes,

$$f_c = \frac{3 \times 10^8}{2 \times 10^{-2} \sqrt{2.25}} \sqrt{\frac{1}{3^2} + \frac{1}{1.25^2}} = \underline{\underline{8.67 \text{ GHz}}}$$

Prob. 12.7

$$u = \frac{\omega}{\beta} = \frac{u'}{\sqrt{1 - (f_c/f)^2}} = \frac{3 \times 10^8}{\sqrt{1 - (6.5/7.2)^2}} = 6.975 \times 10^8 \text{ m/s}$$

$$t = \frac{2l}{u} = \frac{300}{6.975 \times 10^8} = \underline{\underline{430 \text{ ns}}}$$

Prob. 12.8

$$f_c = \frac{u'}{2} \sqrt{(m/a)^2 + (n/b)^2}$$

$$f_{c11} = f_{c03} \longrightarrow \frac{u'}{2} \sqrt{(1/a)^2 + (1/b)^2} = \frac{u'}{2} \sqrt{9/b^2}$$

$$\frac{9}{b^2} = \frac{1}{a^2} + \frac{1}{b^2} \longrightarrow a = \frac{b}{\sqrt{8}}$$

$$f_{c03} = \frac{3u'}{2b} \longrightarrow b = \frac{3c}{2f_{c03}} = \frac{9 \times 10^8}{2 \times 12 \times 10^9} = 3.75 \text{ cm}$$

$$\underline{\underline{a = 1.32 \text{ cm}, b = 3.75 \text{ cm}}}$$

Since $a < b$, the dominant mode is TE_{01}

$$f_{c01} = \frac{c}{2b} = \frac{3 \times 10^8}{2 \times 3.75 \times 10^{-2}} = 4 \text{ GHz} < f = 8 \text{ GHz}$$

Hence, the dominant mode will propagate.

Prob. 12.9 $E_z \neq 0$. This must be TM_{23} mode ($m=2, n=3$). Since $a=2b$,

$$f_c = \frac{c}{4b} \sqrt{m^2 + 4n^2} = \frac{3 \times 10^8}{4 \times 3 \times 10^{-2}} \sqrt{4 + 36} = 15.81 \text{ GHz}, \quad f = \frac{\omega}{2\pi} = \frac{10^{12}}{2\pi} = 159.2 \text{ GHz}$$

$$\eta_{TM} = \frac{1}{377 \sqrt{1 - (15.81/159.2)^2}} = \underline{\underline{375.1 \Omega}}$$

$$\mathcal{P}_{\text{ave}} = \frac{|E_{xs}|^2 + |E_{ys}|^2}{2\eta_{TM}} a_z$$

$$= \frac{\beta^2 E_o^2}{2h^4 \eta_{TM}} \left[(2\pi/a)^2 \cos^2(2\pi x/a) \sin^2(3\pi y/b) + (3\pi/b)^2 \sin^2(2\pi x/a) \cos^2(3\pi y/b) \right] a_z$$

$$P_{ave} = \int \mathcal{P}_{ave} \cdot dS = \int_{x=0}^a \int_{y=0}^b \mathcal{P}_{ave} \cdot dx dy a_z$$

$$= \frac{\beta^2 E_o^2}{2h^4 \eta_{TM}} \frac{1}{4} \left[\frac{4\pi^2}{a^2} + \frac{9\pi^2}{b^2} \right] = \frac{\beta^2 E_o^2}{8h^2 \eta_{TM}}$$

But

$$\beta = \frac{\omega}{c} \sqrt{1 - (f_c / f)^2} = \frac{10^{12}}{3 \times 10^8} \sqrt{1 - (15.81 / 159.2)^2} = 3.317 \times 10^3$$

$$h^2 = \frac{4\pi^2}{a^2} + \frac{9\pi^2}{b^2} = \frac{10\pi^2}{b^2} = 1.098 \times 10^5$$

$$P_{ave} = \frac{(3.317)^2 \times 10^6 \times 25}{8 \times (1.098 \times 10^5)^2 \times 375.4} = \underline{\underline{0.8347 \text{ W}}}$$

Prob. 12.10 (a) Since $m=2$ and $n=1$, we have TE₂₁ mode

(b) $\beta = \beta' \sqrt{1 - (f_c / f)^2} = \omega \sqrt{\mu_o \epsilon_o} \sqrt{1 - (\omega_c / \omega)^2}$

$$\beta c = \sqrt{\omega^2 - \omega_c^2} \quad \longrightarrow \quad \omega_c^2 = \sqrt{\omega^2 - \beta^2 c^2}$$

$$f_c = \frac{\omega_c}{2\pi} = \sqrt{f^2 - \frac{\beta^2 c^2}{4\pi^2}} = \sqrt{36 \times 10^{18} - \frac{144 \times 9 \times 10^{16}}{4\pi^2}} = \underline{\underline{5.973 \text{ GHz}}}$$

(c) $\eta_{TE} = \frac{\eta}{\sqrt{1 - (f_c / f)^2}} = \frac{377}{\sqrt{1 - (5.973 / 6)^2}} = \underline{\underline{3978 \Omega}}$

(d) For TE mode,

$$E_y = \frac{\omega \mu}{h^2} (m\pi / a) H_o \sin(m\pi x / a) \cos(n\pi y / b) \sin(\omega t - \beta z)$$

$$H_x = \frac{-\beta}{h^2} (m\pi / a) H_o \sin(m\pi x / a) \cos(n\pi y / b) \sin(\omega t - \beta z)$$

$$\beta = 12, m = 2, n = 1$$

$$E_{oy} = \frac{\omega \mu}{h^2} (m\pi / a) H_o, \quad H_{ox} = \frac{\beta}{h^2} (m\pi / a) H_o$$

$$\eta_{TE} = \frac{E_{oy}}{H_{ox}} = \frac{\omega \mu}{\beta} = \frac{2\pi \times 6 \times 10^9 \times 4\pi \times 10^{-7}}{12} = 4\pi^2 \times 100$$

$$H_{ox} = \frac{E_{oy}}{\eta_{TE}} = \frac{5}{4\pi^2 \times 100} = 1.267 \text{ mA/m}$$

$$H_x = -1.267 \sin(m\pi x/a) \cos(n\pi y/b) \sin(\omega t - \beta z) \text{ mA/m}$$

Prob. 12.11 (a) Since $m=2, n=3$, the mode is TE₂₃.

$$(b) \quad \beta = \beta' \sqrt{1 - (f_c/f)^2} = \frac{2\pi f}{c} \sqrt{1 - (f_c/f)^2}$$

But

$$f_c = \frac{u'}{2} \sqrt{(m/a)^2 + (n/b)^2} = \frac{3 \times 10^8}{2 \times 10^{-2}} \sqrt{(2/2.86)^2 + (3/1.016)^2} = 46.19 \text{ GHz}, f = 50 \text{ GHz}$$

$$\beta = \frac{2\pi \times 50 \times 10^9}{3 \times 10^8} \sqrt{1 - (46.19/50)^2} = 400.68 \text{ rad/m}$$

$$\gamma = j\beta = \underline{j400.7 \text{ /m}}$$

$$(c) \quad \eta = \frac{\eta'}{\sqrt{1 - (f_c/f)^2}} = \frac{377}{\sqrt{1 - (46.19/50)^2}} = \underline{\underline{985.3\Omega}}$$

Prob. 12.12

$$P_{ave} = \frac{1}{2\eta} \int_{y=0}^b \int_0^a (|E_{xs}|^2 + |E_{ys}|^2) dx dy$$

But

$$E_{xs} = \frac{-j\beta}{h^2} (\pi/a) H_o \cos(\pi x/a) \sin(\pi y/b) e^{-j\beta z}$$

$$E_{ys} = \frac{-j\beta}{h^2} (\pi/b) E_o \sin(\pi x/a) \cos(\pi y/b) e^{-j\beta z}$$

$$\begin{aligned} P_{ave} &= \frac{1}{2\eta_{TM11}} \frac{\beta^2 \pi^2}{h^4} E_o^2 \left[\frac{1}{a^2} \int_0^a \cos^2(\pi x/a) dx \int_0^b \sin^2(\pi x/b) dy \right. \\ &\quad \left. + \frac{1}{b^2} \int_0^a \sin^2(\pi x/a) dx \int_0^b \cos^2(\pi x/b) dy \right] \\ &= \frac{1}{2\eta_{TM11}} \frac{\beta^2 \pi^2}{h^4} E_o^2 \left[\frac{1}{a^2} + \frac{1}{b^2} \right] (a/2)(b/2) \end{aligned}$$

Note that $h^2 = \frac{\pi^2}{a^2} + \frac{\pi^2}{b^2} = \frac{a^2 + b^2}{a^2 b^2} \pi^2$

$$P_{ave} = \frac{\beta^2 E_o^2}{8\pi^2 \eta_{TM11}} \frac{a^3 b^3}{a^2 + b^2}$$

Prob. 12.13 (a)

$$f_c = \frac{u'}{2} \sqrt{(m/a)^2 + (n/b)^2}, \beta = \beta' \sqrt{1 - (f_c/f)^2}$$

$$u = \omega / \beta = \frac{u'}{\sqrt{1 - (f_c/f)^2}}, \lambda = 2\pi / \beta = \frac{\lambda'}{\sqrt{1 - (f_c/f)^2}}$$

(b) If $a = 2b = 2.5\text{cm}$, $f_c = \frac{u'}{2a} \sqrt{m^2 + 4n^2}$. For TE_{11} ,

$$f_c = \frac{3 \times 10^8}{2 \times 2.5 \times 10^{-2}} \sqrt{1 + 4} = 13.42 \text{ GHz}, \quad u = \frac{3 \times 10^8}{\sqrt{1 - (13.42/20)^2}} = \underline{\underline{4.06 \times 10^8}} \text{ m/s}$$

$$\lambda = u/f = \frac{4.046 \times 10^8}{200 \times 10^8} = \underline{\underline{2.023}} \text{ cm}$$

For TE_{21} ,

$$f_c = \frac{3 \times 10^8}{2 \times 2.5 \times 10^{-2}} \sqrt{4 + 4} = 16.97 \text{ GHz}, \quad u = \frac{3 \times 10^8}{\sqrt{1 - (16.97/20)^2}} = \underline{\underline{5.669 \times 10^8}} \text{ m/s}$$

$$\lambda = u/f = \frac{5.669 \times 10^8}{200 \times 10^8} = \underline{\underline{2.834}} \text{ cm}$$

Prob. 12.14 (a)

$$f_c = \frac{u'}{2} \sqrt{(m/a)^2 + (n/b)^2} = \frac{3 \times 10^8}{2 \times 10^{-2}} \sqrt{1/1 + 4/9} = 18.03 \text{ GHz}$$

$$f = 1.2 f_c = \underline{\underline{21.63}} \text{ GHz}$$

(b) $\sqrt{1 - (f_c/f)^2} = \sqrt{1 - (1/1.2)^2} = 0.5528$

$$u_r = \frac{c}{\sqrt{1 - (f_c/f)^2}} = \frac{3 \times 10^8}{0.5528} = \underline{\underline{5.427 \times 10^8}} \text{ m/s}$$

$$u_x = u \sqrt{1 - (f_c/f)^2} = 3 \times 10^8 \times 0.5528 = \underline{\underline{1.658 \times 10^8}} \text{ m/s}$$

Prob. 12.15

$$f_c = \frac{3 \times 10^8}{2} \sqrt{(m/0.025)^2 + (n/0.01)^2} = 15 \sqrt{n^2 + (m/2.5)^2} \text{ GHz}$$

$$f_{c10} = 6 \text{ GHz}, f_{c20} = 12 \text{ GHz}, f_{c01} = 15 \text{ GHz}.$$

Since $f_{c20}, f_{c10} > 11 \text{ GHz}$, only the dominant TE_{10} mode is propagated.

$$(a) \frac{u_p}{u} = \frac{1}{\sqrt{1 - (f_c/f)^2}} = \frac{1}{\sqrt{1 - (6/11)^2}} = \underline{1.193}$$

$$(b) \frac{u_g}{u} = \sqrt{1 - (6/11)^2} = \underline{0.8381}$$

$$\text{Prob. 12.16 Let } F = \sqrt{1 - (f_c/f)^2} = \sqrt{1 - (16/24)^2} = 0.7453$$

$$u' = \frac{1}{\sqrt{\mu\epsilon}} = \frac{3 \times 10^8}{\sqrt{2.25}} = 2 \times 10^8, \quad u_p = \frac{u'}{F}, \quad u_g = u' F = 2 \times 10^8 \times 0.7453 = \underline{1.491 \times 10^8} \text{ m/s}$$

$$\eta_{TE} = \eta' / F = \frac{377}{1.5 \times 0.7453} = \underline{337.2 \Omega}$$

Prob. 12.17 In free space,

$$\eta_1 = \frac{\eta_0}{\sqrt{1 - (f_c/f)^2}}, \quad f_c = \frac{c}{2a} = \frac{3 \times 10^8}{2 \times 5 \times 10^{-2}} = 3 \text{ GHz}$$

$$\eta_1 = \frac{377}{\sqrt{1 - (3/8)^2}} = 406.7$$

$$\eta_2 = \frac{\eta'_1}{\sqrt{1 - (f_c/f)^2}}, \quad \eta'_1 = \frac{120\pi}{\sqrt{2.25}} = 80\pi, \quad f_c = \frac{u'}{2a}, \quad u' = \frac{c}{\sqrt{\epsilon_r}}$$

$$f_c = \frac{3 \times 10^8}{2 \times 5 \times 10^{-2} \sqrt{2.25}} = 2 \text{ GHz}, \quad \eta_2 = \frac{80\pi}{\sqrt{1 - (2/8)^2}} = 82.62$$

$$\Gamma = \frac{\eta_2 - \eta_1}{\eta_2 + \eta_1} = \frac{82.62 - 406.7}{82.62 + 406.7} = -0.662$$

$$s = \frac{1 + |\Gamma|}{1 - |\Gamma|} = \frac{1.662}{0.338} = \underline{4.917}$$

Prob. 12.18 Substituting $E_z = R\Phi Z$ into the wave equation,

$$\frac{\Phi Z}{\rho} \frac{d}{d\rho}(\rho R') + \frac{RZ}{\rho^2} \Phi'' + R\Phi Z'' + k^2 R\Phi Z = 0$$

Dividing by $R\Phi Z$,

$$\frac{1}{R\rho} \frac{d}{d\rho}(\rho R') + \frac{\Phi''}{\Phi\rho^2} + k^2 = -\frac{Z''}{Z} = -k_z^2$$

i.e. $Z'' - k_z^2 Z = 0$

$$\frac{1}{R\rho} \frac{d}{d\rho}(\rho R') + \frac{\Phi''}{\Phi\rho^2} + (k^2 + k_z^2) = 0$$

$$\frac{\rho}{R} \frac{d}{d\rho}(\rho R') + (k^2 + k_z^2)\rho^2 = -\frac{\Phi''}{\Phi} = k_\rho^2$$

or

$$\Phi'' + k_\rho^2 \Phi = 0$$

$$\rho \frac{d}{d\rho}(\rho R') + (k_\rho^2 \rho^2 - k_\rho^2)R = 0, \text{ where } k_\rho^2 = k^2 + k_z^2. \text{ Hence}$$

$$\rho^2 R'' + \rho R' + (k_\rho^2 \rho^2 - k_\rho^2)R = 0$$

Prob. 12.19

$$\mathcal{P}_{\text{ave}} = \frac{|E_{xs}|^2 + |E_{ys}|^2}{2\eta} a_z = \frac{\omega^2 \mu^2 \pi^2}{2\eta b^2 h^4} H_o^2 \sin^2 \pi y / ba_z$$

$$P_{\text{ave}} = \int \mathcal{P}_{\text{ave}} \cdot dS = \frac{\omega^2 \mu^2 \pi^2}{2\eta b^2 h^4} H_o^2 \int_{x=0}^a \int_{y=0}^b \sin^2 \pi y / b dx dy$$

$$P_{\text{ave}} = \frac{\omega^2 \mu^2 \pi^2}{2\eta b^2 h^4} H_o^2 ab / 2$$

But $h^2 = (m\pi/a)^2 + (n\pi/b)^2 = \frac{\pi^2}{b^2}$.

$$P_{\text{ave}} = \frac{\omega^2 \mu^2 a b^3 H_o^2}{4\pi^2 \eta}$$

Prob. 12.20

$$R_s = \sqrt{\frac{\pi \mu f}{\sigma_c}} = \sqrt{\frac{\pi \times 12 \times 10^9 \times 4\pi \times 10^{-7}}{5.8 \times 10^7}} = 2.858 \times 10^{-2}$$

$$f_{c10} = \frac{u'}{2a} = \frac{3 \times 10^8}{2\sqrt{2.6 \times 2 \times 10^{-2}}} = 4.651 \text{ GHz}$$

$$f_{c11} = \frac{u'}{2} \left[\frac{1}{a^2} + \frac{1}{b^2} \right]^{1/2} = 10.4 \text{ GHz}$$

$$\eta' = \sqrt{\frac{\mu}{\epsilon}} = \frac{377}{\sqrt{2.6}} = 233.81 \Omega$$

(a) For TE₁₀ mode, eq.(12.57) gives

$$\begin{aligned} \alpha_d + j\beta_d &= \sqrt{-\omega^2 \mu \epsilon + k_x^2 + k_x^2 + j\omega \mu \sigma_d} \\ &= \sqrt{-\omega^2 / u^2 + \frac{\pi^2}{a^2} + j\omega \mu \sigma_d} \\ &= \sqrt{-\left(\frac{2\pi \times 12 \times 10^9}{3 \times 10^8}\right)^2 (2.6) + \frac{\pi^2}{(2 \times 10^{-2})^2} + j2\pi \times 12 \times 10^9 \times 4\pi \times 10^{-7} \times 10^{-4}} \\ &= 0.012682 + j373.57 \end{aligned}$$

$$\alpha_d = 0.012682 \text{ Np/m}$$

$$\begin{aligned} \alpha_c &= \frac{2R_s}{b\eta' \sqrt{1 - (f_c/f)^2}} \left[\frac{1}{2} + \frac{b}{a} \left(\frac{f_c}{f}\right)^2 \right] \\ &= \frac{2 \times 2.858 \times 10^{-2}}{10^{-2} (233.81) \sqrt{1 - (4.651/12)^2}} \left[\frac{1}{2} + \frac{1}{2} \left(\frac{4.651}{12}\right)^2 \right] = \underline{0.1525} \text{ Np/m} \end{aligned}$$

(b) For TE₁₁ mode,

$$\alpha_d + j\beta_d = \sqrt{-\omega^2 / u^2 + 1/a^2 + 1/b^2 + j\omega \mu \sigma_d}$$

$$= \sqrt{-139556.21 + \frac{\pi^2}{(10^{-2})^2} + j9.4748} = 0.02344 + j202.14$$

$$\underline{\alpha_d = 0.02344 \text{ Np/m}}$$

$$\alpha_c = \frac{2R_s}{b\eta' \sqrt{1 - (f_c/f)^2}} \left[\frac{(b/a)^3 + 1}{(b/a)^2 + 1} \right] = \frac{2 \times 2.858 \times 10^{-2}}{10^{-2} (233.81) \sqrt{1 - (10.4/12)^2}} \left[\frac{(1/8) + 1}{(1/4) + 1} \right]$$

$$\underline{\alpha_c = 0.0441 \text{ Np/m}}$$

Prob. 12.21 $\epsilon_c = \epsilon' - j\epsilon'' = \epsilon - j \frac{\sigma}{\omega}$

Comparing this with

$$\epsilon_c = 16\epsilon_o(1 - j10^{-4}) = 16\epsilon_o - j16\epsilon_o \times 10^{-4}$$

$$\epsilon = 16\epsilon_o, \quad \frac{\sigma}{\omega} = 16\epsilon_o \times 10^{-4}$$

For TM₂₁ mode,

$$f_c = \frac{u'}{2} \left[\frac{m^2}{a^2} + \frac{n^2}{b^2} \right]^{1/2} = 4.193 \text{ GHz}, \quad f = 1.1f_c = 4.6123 \text{ GHz}$$

$$\sigma = 16\epsilon_o \omega \times 10^{-4} = 16 \times 2\pi \times 4.6123 \times 10^9 \times \frac{10^{-9}}{36\pi} \times 10^{-4} = 4.1 \times 10^{-4}$$

$$\eta' = \sqrt{\frac{\mu}{\epsilon}} = 30\pi$$

$$\alpha_d = \frac{\sigma \eta'}{2\sqrt{1 - (f_c/f)^2}} = \frac{4.1 \times 10^{-4} \times 30\pi}{2\sqrt{1 - 1/1.12}} = \underline{\underline{0.04637}} \text{ Np/m}$$

$$E_o e^{-\alpha_d z} = 0.8 E_o \quad \longrightarrow \quad z = \frac{1}{\alpha_d} \ln(1/0.8) = \underline{\underline{4.811}} \text{ cm}$$

Prob. 12.22 For TM₂₁ mode,

$$\alpha_c = \frac{2R_s}{b\eta' \sqrt{1 - (f_c/f)^2}}$$

$$R_s = \frac{1}{\sigma_c \delta} = \sqrt{\frac{\pi f \mu}{\sigma_c}} = \sqrt{\frac{\pi \times 4.6123 \times 10^9 \times 4\pi \times 10^{-7}}{1.5 \times 10^7}} = 3.484 \times 10^{-2}$$

$$\alpha_c = \frac{2 \times 3.48 \times 10^{-2}}{4\pi \times 10^{-2} \times 30\pi \times 0.4166} = 0.04406 \text{ Np/m}$$

$$E_o e^{-\alpha_c z} = 0.7 E_o \quad \longrightarrow \quad z = \frac{1}{\alpha_c} \ln(1/0.7) = \underline{\underline{8.097 \text{ m}}}$$

Prob. 12.23 For TE₁₀ mode,

$$f_c = \frac{u'}{2a} = \frac{3 \times 10^8}{2\sqrt{2.11 \times 4.8 \times 10^{-2}}} = 2.151$$

$$(a) \text{ loss tangent} = \frac{\sigma}{\omega \epsilon} = d$$

$$\sigma = d\omega\epsilon = 3 \times 10^{-4} \times 2\pi \times 4 \times 10^9 \times 2.11 \times \frac{10^{-9}}{36\pi} = 1.407 \times 10^{-4}$$

$$\eta' = \frac{120\pi}{\sqrt{2.11}} = 259.53$$

$$\alpha_d = \frac{\sigma \eta'}{2\sqrt{1 - (f_c/f)^2}} = \frac{1.4067 \times 10^{-4} \times 259.53}{2\sqrt{1 - (2.151/4)^2}} = \underline{\underline{2.165 \times 10^{-2} \text{ Np/m}}}$$

$$(b) R_s = \sqrt{\frac{\mu f \pi}{\sigma_c}} = \sqrt{\frac{\pi \times 4 \times 10^9 \times 4\pi \times 10^{-7}}{4.1 \times 10^7}} = 1.9625 \times 10^{-2}$$

$$\alpha_c = \frac{2R_s}{b\eta' \sqrt{1 - (f_c/f)^2}} \left[\frac{1}{2} + \frac{b}{a} (f_c/f)^2 \right] = \frac{3.925 \times 10^{-2} (0.5 + 0.5 \times 0.2892)}{2.4 \times 10^{-2} \times 259.53 \times 0.8431}$$

$$= \underline{\underline{4.818 \times 10^{-3} \text{ Np/m}}}$$

Prob. 12.24 (a) For TE₁₀ mode,

$$f_c = \frac{u'}{2a}, \quad u' = \frac{c}{\sqrt{2.11}}$$

$$f_c = \frac{3 \times 10^8}{\sqrt{2.11} (2 \times 2.25 \times 10^{-2})} = \underline{\underline{4.589 \text{ GHz}}}$$

$$(b) \quad \alpha_{TE_{10}} = \frac{2R_s}{b\eta' \sqrt{1 - (f_c/f)^2}} \left[\frac{1}{2} + \frac{b}{a} (f_c/f)^2 \right]$$

$$R_s = \sqrt{\frac{\pi f \mu}{\sigma_c}} = \sqrt{\frac{\pi \times 5 \times 10^9 \times 4\pi \times 10^{-7}}{1.37 \times 10^7}} = 3.796 \times 10^{-3}$$

$$\eta' = \frac{377}{\sqrt{2.11}} = 259.54$$

$$\alpha_c = \frac{2 \times 3.796 \times 10^{-2} \left[0.5 + \frac{1.5}{2.25} (4.589/5)^2 \right]}{1.5 \times 10^{-4} (259.54) \sqrt{1 - (4.589/5)^2}} = \underline{\underline{0.05217}} \text{ Np/m}$$

Prob. 12.25 For TE₁₀ mode,

$$\alpha_c = \frac{2R_s}{b\eta' \sqrt{1 - (f_c/f)^2}} \left[\frac{1}{2} + \frac{b}{a} \left(\frac{f_c}{f}\right)^2 \right]$$

But $a = b$, $R_s = \frac{1}{\sigma_c \delta} = \sqrt{\frac{\pi f \mu}{\sigma_c}}$

$$\alpha_c = \frac{2 \sqrt{\frac{\pi f \mu}{\sigma_c}}}{\sigma \eta' \sqrt{1 - (f_c/f)^2}} \left[\frac{1}{2} + \left(\frac{f_c}{f}\right)^2 \right] = \frac{k \sqrt{f} \left[\frac{1}{2} + \left(\frac{f_c}{f}\right)^2 \right]}{\sqrt{1 - (f_c/f)^2}}$$

where k is a constant.

$$\frac{d\alpha_c}{df} = \frac{k \left[1 - \left(\frac{f_c}{f}\right)^2 \right]^{-1/2} \left[\frac{1}{4} f^{-1/2} - \frac{3}{2} f_c^2 f^{-5/2} \right] - \frac{k}{2} \left[\frac{1}{2} f^{1/2} + f_c^2 f^{-3/2} \right] (2f_c^2 f^{-3}) \left[1 - \left(\frac{f_c}{f}\right)^2 \right]^{-1/2}}{1 - (f_c/f)^2}$$

For minimum value, $\frac{d\alpha_c}{df} = 0$. This leads to $f = \underline{\underline{2.962 f_c}}$.

Prob. 12.26

$$\alpha = k \sqrt{\frac{f}{1 - (f_c/f)^2}}, \text{ where } k \text{ is a constant}$$

$$\alpha = k \frac{f^{3/2}}{\sqrt{f^2 - f_c^2}}$$

$$\frac{d\alpha}{df} = k \frac{\sqrt{f^2 - f_c^2} \cdot \frac{3}{2} f^{1/2} - f^{3/2} \cdot \frac{1}{2} \cdot 2f \cdot \frac{1}{\sqrt{f^2 - f_c^2}}}{f^2 - f_c^2}$$

For maximum α , $\frac{d\alpha}{df} = 0$ which implies that

$$(f^2 - f_c^2) \cdot \frac{3}{2} f^{1/2} - f^{5/2} = 0$$

or

$$\underline{f = \sqrt{3} f_c}$$

Prob. 12.27 For the TE mode to z ,

$$E_{zs} = 0, H_{zs} = H_0 \cos(m\pi x/a) \cos(n\pi y/b) \sin(p\pi z/c)$$

$$E_{ys} = -\frac{\gamma}{h^2} \frac{\partial E_{zs}}{\partial y} + \frac{j\omega\mu}{h^2} \frac{\partial H_{zs}}{\partial x} = -\frac{j\omega\mu}{h^2} (m\pi/a) H_0 \sin(m\pi x/a) \cos(n\pi y/b) \sin(p\pi z/c)$$

as required.

$$E_{xs} = -\frac{\gamma}{h^2} \frac{\partial E_{zs}}{\partial x} - \frac{j\omega\mu}{h^2} \frac{\partial H_{zs}}{\partial y} = \frac{j\omega\mu}{h^2} (n\pi/b) H_0 \cos(m\pi x/a) \sin(n\pi y/b) \sin(p\pi z/c)$$

From Maxwell's equation,

$$-j\omega\mu H_s = \nabla \times E_s = \begin{vmatrix} \frac{\partial}{\partial x} & \frac{\partial}{\partial y} & \frac{\partial}{\partial z} \\ E_{xs} & E_{ys} & 0 \end{vmatrix}$$

$$H_{xs} = \frac{1}{j\omega\mu} \frac{\partial E_{ys}}{\partial z} = -\frac{1}{h^2} (m\pi/a)(p\pi/c) H_0 \sin(m\pi x/a) \cos(n\pi y/b) \cos(p\pi z/c)$$

Prob. 12.28 Maxwell's equation can be written as

$$H_{xs} = \frac{j\omega\epsilon}{h^2} \frac{\partial E_{zs}}{\partial y} - \frac{\gamma}{h^2} \frac{\partial H_{zs}}{\partial x}$$

For a rectangular cavity,

$$h^2 = k_x^2 + k_y^2 = (m\pi/a)^2 + (n\pi/b)^2$$

For TM mode, $H_{zs} = 0$ and

$$E_{zs} = E_o \sin(m\pi x/a) \sin(n\pi y/b) \cos(p\pi z/c)$$

Thus

$$H_{xs} = \frac{j\omega\epsilon}{h^2} \frac{\partial E_{zs}}{\partial y} = \frac{j\omega\epsilon}{h^2} (n\pi/b) E_o \sin(m\pi x/a) \cos(n\pi y/b) \sin(p\pi z/c)$$

as required.

$$\begin{aligned} H_{xs} &= -\frac{j\omega\epsilon}{h^2} \frac{\partial E_{zs}}{\partial x} - \frac{\gamma}{h^2} \frac{\partial H_{zs}}{\partial y} \\ &= -\frac{j\omega\epsilon}{h^2} (m\pi/a) E_o \cos(m\pi x/a) \sin(n\pi y/b) \cos(p\pi z/c) \end{aligned}$$

From Maxwell's equation,

$$j\omega\epsilon E_s = \nabla \times H_s = \begin{vmatrix} \frac{\partial}{\partial x} & \frac{\partial}{\partial y} & \frac{\partial}{\partial z} \\ H_{xs} & H_{ys} & 0 \end{vmatrix}$$

$$E_{ys} = \frac{1}{j\omega\epsilon} \frac{\partial H_{xs}}{\partial z} = -\frac{1}{h^2} (n\pi/b)(p\pi/c) E_o \sin(m\pi x/a) \cos(n\pi y/b) \sin(p\pi z/c)$$

Prob. 12.29

$$f_r = \frac{u'}{2} \sqrt{(m/a)^2 + (n/b)^2 + (p/c)^2}$$

where for TM mode to z, $m = 1, 2, 3, \dots$, $n = 1, 2, 3, \dots$, $p = 0, 1, 2, \dots$

and for TE mode to z, $m = 1, 2, 3, \dots$, $n = 1, 2, 3, \dots$, $p = 1, 2, 3, \dots$

(a) If $a < b < c$, $1/a > 1/b > 1/c$,

The lowest TM mode is TM_{110} with $f_r = \frac{u'}{2} \sqrt{\frac{1}{a^2} + \frac{1}{b^2}}$

The lowest TE mode is TE_{011} with $f_r = \frac{u'}{2} \sqrt{\frac{1}{b^2} + \frac{1}{c^2}} < \frac{u'}{2} \sqrt{\frac{1}{a^2} + \frac{1}{b^2}}$

Hence the dominant mode is TE₀₁₁.

(b) If $a > b > c$, $1/a < 1/b < 1/c$,

The lowest TM mode is TM₁₁₀ with $f_r = \frac{u'}{2} \sqrt{\frac{1}{a^2} + \frac{1}{b^2}}$

The lowest TE mode is TE₁₀₁ with $f_r = \frac{u'}{2} \sqrt{\frac{1}{a^2} + \frac{1}{c^2}} < \frac{u'}{2} \sqrt{\frac{1}{a^2} + \frac{1}{b^2}}$

Hence the dominant mode is TM₁₁₀.

(c) If $a = c > 1/b$, $1/a = 1/c < 1/b$,

The lowest TM mode is TM₁₁₀ with $f_r = \frac{u'}{2} \sqrt{\frac{1}{a^2} + \frac{1}{b^2}}$

The lowest TE mode is TE₁₀₁ with $f_r = \frac{u'}{2} \sqrt{\frac{1}{a^2} + \frac{1}{c^2}} < \frac{u'}{2} \sqrt{\frac{1}{a^2} + \frac{1}{b^2}}$

Hence the dominant mode is TE₁₀₁.

Prob. 12.30

$$f_r = 1.5 \times 10^{10} \sqrt{(m/3)^2 + (n/2)^2 + (p/4)^2} \text{ Hz}$$

$$f_{r_{TE_{011}}} = 15 \sqrt{0 + 1/4 + 1/16} = 8.385 \text{ GHz, etc.}$$

The resonant frequencies are listed below.

Modes	Resonant frequencies (GHz)
TE ₁₀₁	6.25
TE ₀₁₁	8.38
TM ₁₁₀	9.01
TM ₁₁₁	9.76

Prob. 12.31 $b = 2a$, $c = 3a$

$$f_r = \frac{u'}{2} \sqrt{(m/a)^2 + (n/2a)^2 + (p/3a)^2}, u' = \frac{c}{\sqrt{2.5}}$$

$$\frac{u'}{2a} = \frac{3 \times 10^8}{2\sqrt{2.5 \times 3 \times 10^{-2}}} = 3.162 \times 10^9$$

$$f_r = 3.162 \sqrt{m^2 + n^2/4 + p^2/9} \text{ GHz}$$

Mode	f_r (GHz)
011	1.9
110	3.535
101	3.333
102	3.8
120, 103	4.472
022	3.8

Thus the lowest five modes have resonant frequencies at

1.9, 3.333, 3.535, 3.8, and 4.472 GHz

Prob. 12.32

$$f_r = \frac{u'}{2} \sqrt{1/a^2 + 1/c^2}$$

For cubical cavity, $a = b = c$

$$f_r = \frac{u'}{2a} \sqrt{2} \longrightarrow a = \frac{u'}{\sqrt{2}f_r} = \frac{3 \times 10^8}{\sqrt{2} \times 2 \times 10^9} = 10.61 \text{ mm}$$

$$\underline{a = b = c = 1.061 \text{ cm}}$$

Prob. 12.33 (a)

$$f_r = \frac{u'}{2} \sqrt{(m/a)^2 + (n/b)^2 + (p/c)^2}$$

$a = b = c = 3.2 \text{ cm}$, $m=1$, $n=0$, $p=1$, $u' = c$

$$f_r = \frac{3 \times 10^8}{2 \times 3.2 \times 10^{-2}} \sqrt{1^2 + 0^2 + 1^2} = \underline{6.629 \text{ GHz}}$$

(b)

$$Q = \frac{a}{3} \sqrt{\pi f_r \mu_0 \sigma_c} = \frac{3.2 \times 10^{-2}}{3} \sqrt{\pi \times 6.629 \times 10^9 \times 4\pi \times 10^{-7} \times 1.57 \times 10^{-7}}$$

$$= 6.387$$

Prob. 12.34

$$f_r = \frac{c}{2a} \sqrt{m^2 + n^2 + p^2}$$

The lowest possible modes are TE_{101} , TE_{011} , and TM_{110} . Hence

$$f_r = \frac{c}{2a} \sqrt{2} \longrightarrow a = \frac{c}{f_r \sqrt{2}} = \frac{3 \times 10^8}{\sqrt{2} \times 3 \times 10^9} = 7.071 \text{ cm}$$

$$\underline{a = b = c = 7.071 \text{ cm}}$$

Prob. 12.35 This is a TM mode to z. From Maxwell's equations,

$$\nabla \times E_s = -j\omega \mu H_s$$

$$H_s = -\frac{1}{j\omega \mu} \nabla \times E_s = \frac{j}{\omega \mu} \begin{vmatrix} \frac{\partial}{\partial x} & \frac{\partial}{\partial y} & \frac{\partial}{\partial z} \\ 0 & 0 & E_{zs}(x, y) \end{vmatrix} = \frac{j}{\omega \mu} \left(\frac{\partial E_{zs}}{\partial y} a_x - \frac{\partial E_{zs}}{\partial x} a_y \right)$$

But

$$E_{zs} = 200 \sin 30\pi x \sin 30\pi y, \frac{1}{\omega \mu} = \frac{1}{6 \times 10^9 \times 4\pi \times 10^{-7}} = \frac{10^{-2}}{24\pi}$$

$$H_s = \frac{j10^{-2}}{24\pi} \times 200 \times 30\pi \left\{ \sin 30\pi x \cos 30\pi y a_x - \cos 30\pi x \sin 30\pi y a_y \right\}$$

$$\mathbf{H} = \text{Re} (\mathbf{H}_s e^{j\omega t})$$

$$\underline{H = 2.5 \left\{ -\sin 30\pi x \cos 30\pi y a_x + \cos 30\pi x \sin 30\pi y a_y \right\} \sin 6 \times 10^9 \pi t \text{ A/m}}$$

CHAPTER 13

P. E. 13.1

$$r_{\max} = \frac{2d^2}{\lambda} = \frac{2(\lambda/100)^2}{\lambda} = \frac{\lambda}{5,000} \implies r = \frac{\lambda}{5} \text{ is in far field}$$

$$(a) H_{\phi_s} = \frac{jI_0 \beta \partial l \sin \theta e^{j\beta r}}{4\pi r}, \quad \beta r = \frac{2\pi}{\lambda} \cdot \frac{\lambda}{5} = 72^\circ$$

$$\lambda = \frac{2\pi c}{\omega} = \frac{2\pi \times 3 \times 10^8}{10^8} = 6\pi$$

$$H_{\phi_s} = \frac{j(0.25)\left(\frac{2\pi}{\lambda}\right)\frac{\lambda}{100} \sin 30^\circ e^{-j72^\circ}}{4\pi(6\pi/5)} = 0.1652e^{j18^\circ} \text{ r } \sqrt{\text{m}}$$

$$H = \text{Im} \left(H_{\phi_s} e^{j\omega t} a_\phi \right) \quad \text{Im is used since } I = I_0 \sin \omega t$$

$$= \underline{\underline{0.1628 \sin(10^8 t + 18^\circ) a_\phi}} \text{ mA/m}$$

$$(b) \beta = \frac{2\pi}{\lambda} \cdot 200\lambda = 0^\circ$$

$$H_{\phi_s} = \frac{j(0.25)\left(\frac{2\pi}{\lambda}\right)\frac{\lambda}{100} \sin 60^\circ e^{-j0^\circ}}{4\pi(6\pi \times 200)} = 0.2871e^{j90^\circ} \mu\text{A/m}$$

$$H = \text{Im} \left(H_{\phi_s} a_\phi e^{j\omega t} \right) = \underline{\underline{0.2671 \sin(10^8 t + 90^\circ) a_\phi}} \mu\text{A/m}.$$

P. E. 13.2

$$(a) l = \frac{\lambda}{4} = \underline{\underline{1.5\text{m}}},$$

$$(b) I_0 = \underline{\underline{83.3\text{mA}}}$$

$$(c) P_{\text{rad}} = 36.56 \lambda, \quad P_{\text{rad}} = \frac{l}{2} (0.0833)^2 36.56$$

$$= \underline{\underline{126.8 \text{ mW}}}.$$

$$(d) Z_l = 36.5 + j21.25.$$

$$\Gamma = \frac{36.5 + j21.25 - 75}{36.5 + j21.25 + 75} = 0.3874 \angle 140.3^\circ$$

$$S = \frac{1 + 0.3874}{1 - 0.3874} = \underline{\underline{2.265}}$$

P. E. 13.3

$$D = \frac{4\pi U_{\max}}{P_{\text{rad}}}$$

(a) For the Hertzian monopole

$$U(\theta, \phi) = \sin^2 \theta, \quad 0 < \theta < \frac{\pi}{2}, \quad 0 < \phi < 2\pi, \quad U_{\max} = 1$$

$$P_{\text{rad}} = \int_{\theta=0}^{\pi/2} \int_{\phi=0}^{2\pi} \sin^2 \theta \sin \theta \, d\theta \, d\phi = \frac{4\pi}{3}$$

$$D = \frac{4\pi \cdot 1}{4\pi/3} = \underline{\underline{3}}$$

(b) For the $\frac{\lambda}{4}$ monopole,

$$U(\theta, \phi) = \frac{\cos^2(\frac{\pi}{2} \cos \theta)}{\sin^2 \theta}, \quad U_{\max} = 1$$

$$P_{\text{rad}} = \int_{\theta=0}^{\pi/2} \int_{\phi=0}^{2\pi} \frac{\cos^2(\frac{\pi}{2} \cos \theta)}{\sin^2 \theta} \sin \theta \, d\theta \, d\phi = 2\pi(0.609)$$

$$D = \frac{4\pi(1)}{2\pi(0.609)} = \underline{\underline{3.28}}$$

P. E. 13.4

$$(a) \quad P_{\text{rad}} = \eta_r P_{\text{in}} = 0.95(0.4)$$

$$D = \frac{4\pi U_{\max}}{P_{\text{rad}}} = \frac{4\pi(0.5)}{0.4 \times 0.95} = \underline{\underline{16.53}}$$

$$(b) \quad D = \frac{4\pi(0.5)}{0.3} = \underline{\underline{20.94}}$$

P. E. 13. 5

$$P_{rad} = \int_{\theta=0}^{\pi/2} \int_{\phi=0}^{2\pi} \sin\theta \sin\theta d\theta d\phi = \frac{\pi^2}{2}, U_{max} = 1$$

$$D = \frac{4\pi(l)}{\pi^2/2} = \underline{\underline{2.546}}$$

P. E. 13. 6

$$(a) f(\theta) = |\cos\theta| \cos \left[\frac{l}{2} (\beta d \cos\theta + \alpha) \right]$$

$$\text{where } \alpha = \pi, \beta d = \frac{2\pi}{\lambda} \cdot \frac{\lambda}{2} = \pi$$

$$f(\theta) = |\cos\theta| \cos \left[\frac{l}{2} (\pi \cos\theta + \pi) \right]$$



unit pattern group pattern

For the group pattern, we have nulls at

$$\frac{\pi}{2}(\cos\theta + 1) = \frac{\pi}{2} \quad \longrightarrow \quad \theta = \frac{\pi}{2}$$

and maxima at

$$\frac{\pi}{2}(\cos\theta + 1) = 0 \quad \longrightarrow \quad \cos\theta = -1$$

Thus the group pattern and the resultant patterns are as shown in Fig.13.15(a)

$$(b) f(\theta) = |\cos\theta| \cos \left[\frac{l}{2} (\beta d \cos\theta + \alpha) \right]$$

$$\text{where } \alpha = \pi/2, \beta d = \pi$$

$$f(\theta) = |\cos\theta| \cos \left[\frac{l}{2} (\pi \cos\theta - \pi/2) \right]$$



unit pattern group pattern

For the group pattern, the nulls are at

$$\frac{\pi}{4}(\cos\theta - 1) = \pm \frac{\pi}{2}, \pm \frac{3\pi}{2} \quad \longrightarrow \quad \theta = 180^\circ$$

and maxima at

$$\cos\theta - 1 = 0 \quad \longrightarrow \quad \theta = 0$$

Thus the group pattern and the resultant patterns are as shown in Fig.13.15(b)

P. E. 13.7

(a)

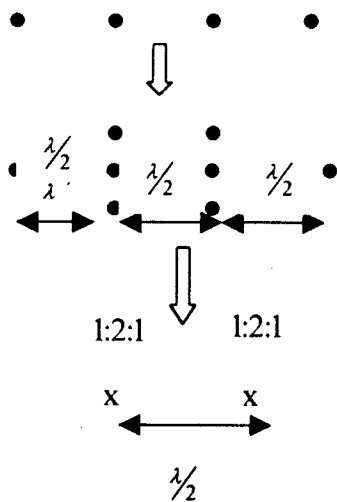

Thus, we take a pair at a time and multiply the patterns as shown below.

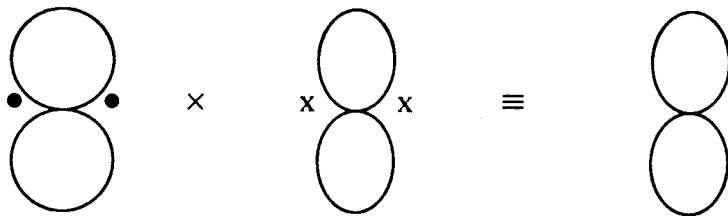

The group pattern is the normalized array factor, i.e.

$$(AF)_n = \sum \left| 1 + Ne^{j\psi} + \frac{N(N-1)}{2!} e^{j2\psi} + \frac{N(N-1)(N-2)}{3!} e^{j3\psi} + \dots + e^{j(N-1)\psi} \right|$$

where $\sum = \sum_{i=1}^{N-1} \binom{N}{i} = 1 + N + \frac{N-1}{2!} + \frac{N(N-1)(N-2)}{3!} + \dots$

$$= (1+1)^{N-1} = 2^{N-1}$$

$$(AF)_n = \frac{1}{2^{N-1}} \left| 1 + e^{j\psi} \right|^{N-1} = \frac{1}{2^{N-1}} \left| e^{j\psi/2} \left(e^{-j\psi/2} + e^{j\psi/2} \right) \right|^{N-1}$$

$$= \frac{1}{2^{N-1}} \left| 2 \cos \frac{\psi}{2} \right|^{N-1} = \left| \cos \frac{\psi}{2} \right|^{N-1}$$

P. E. 13.8

$$A_e = \frac{\lambda^2}{4\pi} G_d, \quad \lambda = \frac{c}{f} = \frac{3 \times 10^8}{10^8} = 3\text{m}$$

For the Hertzian dipole,

$$G_d = 1.5 \sin^2 \theta$$

$$A_e = \frac{\lambda^2}{4\pi} (1.5 \sin^2 \theta)$$

$$A_{e,\max} = \frac{1.5\lambda^2}{4\pi} = \frac{1.5 \times 9}{4\pi} = \underline{\underline{1.074 \text{ m}^2}}$$

By definition,

$$P_r = A_e P_{\text{ave}} \longrightarrow P_{\text{ave}} = \frac{P_r}{A_e} = \frac{3 \times 10^{-6}}{1.074} \\ = \underline{\underline{2.793 \mu\text{W}/\text{m}^2}}$$

P. E. 13.9

$$(a) \quad G_d = \frac{4\pi r^2 P_{\text{ave}}}{P_{\text{rad}}} = \frac{4\pi r^2 \frac{1}{2} \frac{E^2}{\eta}}{P_{\text{rad}}} = \frac{2\pi r^2 E^2}{\eta P_{\text{rad}}} \\ = \frac{2\pi \times 400 \times 10^6 \times 144 \times 10^{-6}}{120\pi \times 100 \times 10^3} = 2.16$$

$$G = 10 \log_{10} G_d = \underline{\underline{3.34 \text{ dB}}}$$

$$(b) \quad G = \eta_r G_d = 0.98 \times 2.16 = \underline{\underline{2.117}}$$

P. E. 13.10

$$r = \left[\frac{\lambda^2 G_d^2 \sigma P_{\text{rad}}}{(4\pi)^3 P_r} \right]^{1/4}$$

$$\text{where } \lambda = \frac{c}{f} = \frac{3 \times 10^8}{6 \times 10^9} = 0.05\text{m}$$

$$A_e = 0.7\pi a^2 = 0.7\pi (1.8)^2 = 7.125\text{m}^2$$

$$G_d = \frac{4\pi A_e}{\lambda^2} = \frac{4\pi(7.125)}{25 \times 10^{-4}} = 3.581 \times 10^4$$

$$r = \left[\frac{5 \times 10^{-4} \times (3.581)^2 \times 10^4 \times 5 \times 60 \times 10^3}{(4\pi)^3 \times 0.26 \times 10^{-3}} \right]^{1/4}$$

$$= 1270 \text{ m} = 0.857 \text{ nm}$$

$$\text{At } r = \frac{r_{\max}}{2} = 635 \text{ m},$$

$$P = \frac{G_d P_{\text{rad}}}{4\pi r^2} = \frac{3.581 \times 10^4 \times 60 \times 10^3}{4\pi (635)^2} = \underline{\underline{42.4 \text{ W/m}^2}}$$

Prob. 13.1

Using vector transformation,

$$A_{rs} = A_{xs} \sin\theta \cos\phi, \quad A_{\theta s} = A_{xs} \cos\theta \cos\phi, \quad A_{\phi s} = A_{xs} \sin\phi$$

$$A_s = \frac{50e^{-j\beta r}}{r} (\sin\theta \cos\phi a_r + \cos\theta \cos\phi a_\theta - \sin\phi a_\phi)$$

$$\begin{aligned} \frac{\nabla \times A_s}{\mu} = H_s &= \frac{-100 \cos\theta \sin\phi}{\mu r^2 \sin\theta} e^{-j\beta r} a_r - \frac{50}{\mu r^2} (\sin\theta + j\beta r) \sin\phi e^{-j\beta r} a_\theta \\ &- \frac{50}{\mu r^2} \cos\theta \cos\phi (1 + j\beta r) e^{-j\beta r} a_\phi \end{aligned}$$

At far field, only $\frac{1}{r}$ term remains. Hence

$$H_s = \frac{-j50}{\mu r} \beta e^{-j\beta r} (\sin\phi a_\theta + \cos\theta \cos\phi a_\phi)$$

$$E_s = -\eta a_r \times H_s = \frac{-j50\beta\eta e^{-j\beta r}}{\mu r} (\sin\phi a_\phi - \cos\theta \cos\phi a_\theta)$$

$$H = \text{Re}[H_s e^{j\omega t}] = \frac{-50}{\mu r} \beta \sin(\omega t - \beta r) (\sin\phi a_\theta + \cos\theta \cos\phi a_\phi)$$

$$E = \text{Re}[E_s e^{j\omega t}] = \frac{-50\eta\beta}{\mu r} \sin(\omega t - \beta r) (-\sin\phi a_\phi + \cos\theta \cos\phi a_\theta)$$

Prob. 13.2

$$\lambda = \frac{c}{f} = \frac{3 \times 10^8}{10^7} = 30 \text{ m}$$

$$|E_{\theta_s}| = \frac{\eta I_o \beta dl}{4\pi r} \sin\theta$$

$$\text{At } (100, 0, 0), r = 100\text{m}, \theta = \frac{\pi}{2}$$

$$|E_{\theta_s}| = \frac{120(10)}{4\pi(100)} \frac{2\pi}{30} (0.2)(1) = \underline{\underline{0.04}} \text{ V/m}$$

Prob. 13.3

$$\lambda = \frac{c}{f} = \frac{3 \times 10^8}{3 \times 10^8} = 1\text{m} \quad \beta = \frac{2\pi}{\lambda} = 2\pi$$

$$r = 10, \theta = 30^\circ, \phi = 90^\circ$$

$$H_{\phi_s} = \frac{j(2)(2\pi)5 \times 10^{-3}}{4\pi} \sin 30 e^{-j2\pi} = \underline{\underline{j0.25}} \text{ mA/m}$$

$$\eta = 120\pi = 377$$

$$E_{\theta_s} = \eta H_{\phi_s} = \underline{\underline{94.25}} \text{ mV/m}$$

Prob. 13.4

$$(a) A_{zs} = \frac{e^{-j\beta r}}{4\pi r} \int_{-1/2}^{1/2} I_o \left(1 - \frac{2|z|}{l}\right) e^{j\beta z \cos\theta} dz$$

$$= \frac{e^{-j\beta r}}{4\pi r} I_o \left[\int_{-1/2}^{1/2} \left(1 - \frac{2|z|}{l}\right) e^{j\beta z \cos\theta} dz + j \int_{-1/2}^{1/2} \left(1 - \frac{2|z|}{l}\right) \sin(\beta z \cos\theta) dz \right]$$

$$= \frac{e^{-j\beta r}}{4\pi r} 2I_o \int_0^{1/2} \left(1 - \frac{2z}{l}\right) \cos(\beta z \cos\theta) dz$$

$$= \frac{I_o e^{-j\beta r}}{2\pi r \beta^2 \cos^2 \theta} \cdot \frac{2}{l} \left[1 - \cos\left(\frac{\beta l}{2} \cos\theta\right) \right]$$

$$E_s = -j\omega\mu A_s \quad \longrightarrow \quad E_{\theta_s} = j\omega\mu \sin\theta A_{zs} = j\beta\eta \sin\theta A_{zs}$$

$$E_{\theta_s} = \frac{j\eta I_o e^{-\beta r} \sin\theta \left[1 - \cos\left(\frac{\beta l}{2} \cos\theta\right) \right]}{\pi r l \beta \cos^2\theta}$$

If $\beta l/2 \ll 1$, $\cos(\beta l/2 \cos\theta) = 1 - \frac{(\beta l/2 \cos\theta)^2}{2!}$. Hence

$$E_{\theta_s} = \frac{j\eta I_o}{8\pi r} \beta l e^{-\beta r} \sin\theta, \quad H_{\phi_s} = \eta E_{\theta_s}$$

$$P_{ave} = \frac{|E_{\theta_s}|^2}{2\eta}, \quad P_{rad} = \int P_{ave}^* dS$$

$$P_{rad} = \int_0^{2\pi} \int_0^\pi \frac{n}{2} \left(\frac{I_o \beta l}{8\pi} \right)^2 \frac{1}{r^2} \sin^2\theta r^2 \sin\theta d\theta d\phi$$

$$= 10\pi^2 I_o^2 \left(\frac{l}{\lambda} \right)^2 = \frac{1}{2} I_o^2 R_{rad}$$

$$\text{or } R_{rad} = 20\pi^2 \left(\frac{l}{\lambda} \right)^2$$

$$(b) \quad 0.5 = 20\pi^2 \left(\frac{l}{\lambda} \right)^2 \longrightarrow l = 0.05\lambda$$

Prob. 13.5

$$\partial l = 5m, \quad \lambda = \frac{c}{f} = \frac{3 \times 10^8}{3 \times 10^6} = 100$$

$$\frac{\partial l}{\lambda} = \frac{5}{100} = \frac{1}{20} < \frac{1}{10}$$

$$R_{rad} = 80\pi^2 \left(\frac{\partial l}{\lambda} \right)^2 = \frac{80\pi^2}{400} = \underline{\underline{1.974\Omega}}$$

Prob. 13.6

$$Z_m = 73 + j42.5$$

$$\Gamma = \frac{Z_m - Z_o}{Z_m + Z_o} = \frac{23 + j42.5}{123 + j42.5} = \underline{\underline{0.3713 \angle 42.52^\circ}}$$

$$s = \frac{1 + |\Gamma|}{1 - |\Gamma|} = \frac{1.3713}{1 - 0.3713} = \underline{\underline{2.181}}$$

Prob. 13.7

This is a monopole antenna

$$\lambda = \frac{c}{f} = \frac{3 \times 10^8}{1.5 \times 10^6} = 200$$

$l \ll \lambda$, hence it is a Hertzian monopole.

$$R_{rad} = \frac{1}{2} 80\pi^2 \left(\frac{dl}{\lambda} \right)^2 = 40\pi^2 \left(\frac{l}{200} \right)^2 = 9.87 \text{ m}\Omega$$

$$P_{rad} = P_t = \frac{1}{2} I_o R_{rad}$$

$$I_o^2 = \frac{2P_t}{R_{rad}} = \frac{8}{9.87 \times 10^{-3}} = 810.54$$

$$\underline{I_o = 28.47 \text{ A}}$$

Prob. 13.8

Change the limits in Eq. (13.16) to $\pm l/2$ i.e.

$$A_s = \frac{\mu I_o e^{-j\beta z \cos\theta}}{4\pi r} \frac{(j\beta \cos\theta \cos\beta l + \beta \sin\beta l)}{-\beta^2 \cos^2\theta + \beta^2} \Big|_{-l/2}^{l/2}$$

$$= \frac{\mu I_o e^{-j\beta r}}{2\pi r} \frac{l}{\beta \sin^2\theta} \left[\sin \frac{\beta l}{2} \cos \left(\frac{\beta l}{2} \cos\theta \right) - \cos\theta \cos \frac{\beta l}{2} \sin \left(\frac{\beta l}{2} \cos\theta \right) \right]$$

But $B = \mu H = \nabla \times A$

$$H_{\phi s} = \frac{l}{\mu r} \left[\frac{\partial}{\partial r} (r A_\theta) - \frac{\partial A_r}{\partial \theta} \right],$$

where $A_\theta = -A_s \sin\theta$, $A_r = A_s \cos\theta$

$$H_{\phi s} = \frac{I_o}{2\pi r} \frac{e^{-j\beta r}}{\beta} \left(\frac{j\beta}{\sin\theta} \right) \left[\sin \frac{\beta l}{2} \cos \left(\frac{\beta l}{2} \cos\theta \right) - \cos\theta \cos \frac{\beta l}{2} \sin \left(\frac{\beta l}{2} \cos\theta \right) \right] + \frac{I_o}{2\pi r^2} e^{-j\beta r} (\dots)$$

For far field, only the $\frac{l}{r}$ -term remains. Hence

$$H_{\theta s} = \frac{jI_0}{2\pi r} e^{-j\beta r} \left[\frac{\sin \frac{\beta l}{2} \cos \left(\frac{\beta l}{2} \cos \theta \right) - \cos \theta \cos \frac{\beta l}{2} \sin \left(\frac{\beta l}{2} \cos \theta \right)}{\sin \theta} \right]$$

$$(b) f(\theta) = \frac{\cos \left(\frac{\beta l}{2} \cos \theta \right) - \cos \frac{\beta l}{2}}{\sin \theta}$$

$$\text{For } l = \lambda, f(\theta) = \frac{\cos(\pi \cos \theta) + 1}{\sin \theta}$$

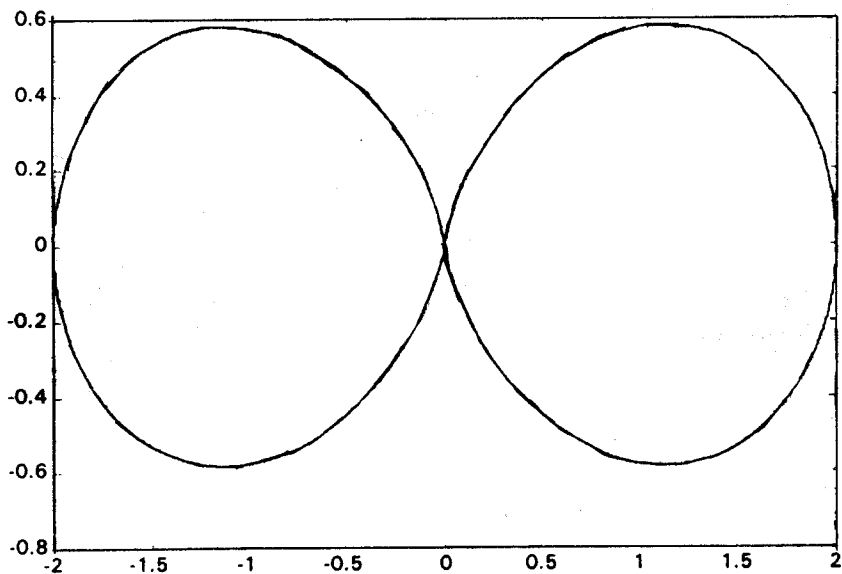

$$\text{For } l = \frac{3\lambda}{2}, f(\theta) = \frac{\cos\left(\frac{3\pi}{2}\cos\theta\right)}{\sin\theta}$$

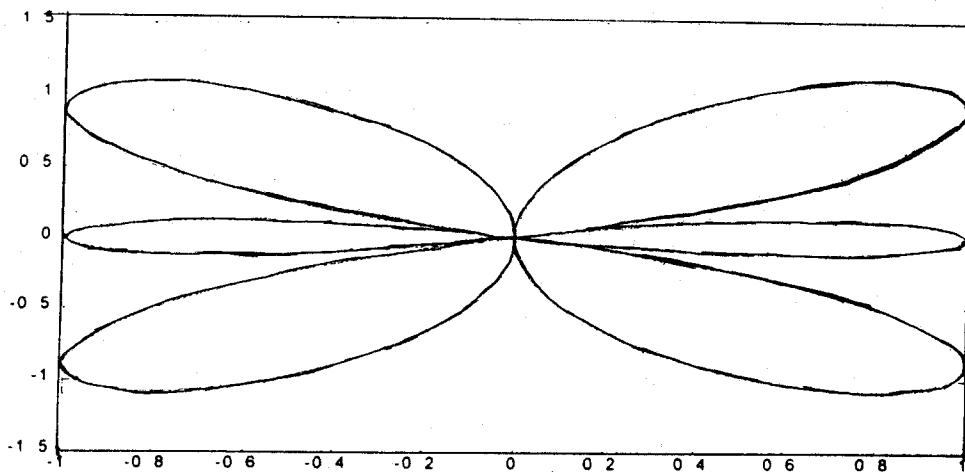

$$\text{For } l = 2\lambda, f(\theta) = \frac{\cos(2\pi\cos\theta) - 1}{\sin\theta}$$

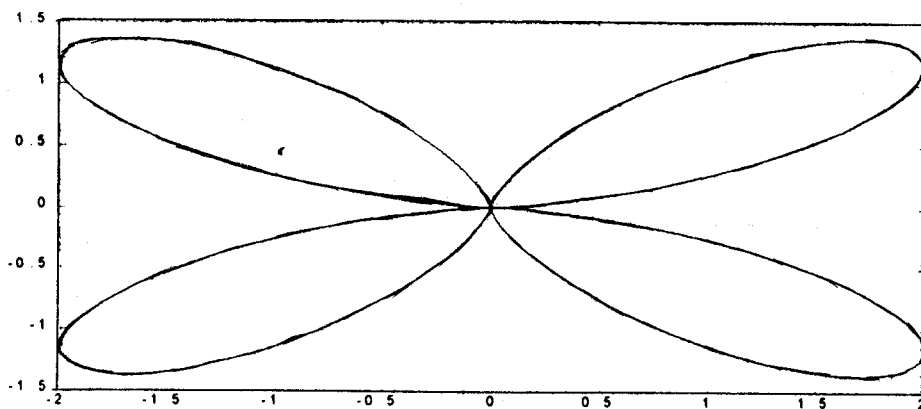

Prob. 13.9

(a) From Prob. 13.4,

$$E_{\theta_s} = \frac{j\eta I_0}{8\pi r} \beta l e^{-j\beta r} \sin\theta, \quad H_{\phi_s} = \eta E_{\theta_s}$$

$$(b) D = \frac{U_{\max}}{U_{\text{ave}}}$$

$$U(\theta, \phi) = \sin^2 \theta, \quad U_{\max} = 1$$

$$U_{\text{ave}} = \frac{P_{\text{rad}}}{4\pi} = \frac{1}{4\pi} \int_{\theta=0}^{\pi} \int_{\phi=0}^{2\pi} \sin^2 \theta \, d\theta \, d\phi$$

$$= \frac{2\pi}{4\pi} \left(\frac{4}{3} \right) = \frac{2}{3}$$

$$D = \frac{1}{2/3} = \underline{\underline{1.5}}$$

Prob. 13.10

$$(a) P_{\text{rad}} = \int P_{\text{rad}} \cdot \partial s = P_{\text{ave}} 2\pi r^2 \quad (\text{hemisphere})$$

$$P_{\text{ave}} = \frac{P_{\text{rad}}}{2\pi r^2} = \frac{200 \times 10^3}{2\pi(50 \times 10^6)} = 1273 \mu\text{W}/\text{m}^2$$

$$P_{\text{ave}} = \underline{\underline{1273 \mu\text{W}/\text{m}^2}}$$

$$(b) P_{\text{ave}} = \frac{(E_{\max})^2}{2\eta}$$

$$E_{\max} = \sqrt{2\eta P_{\text{ave}}} = \sqrt{240\pi \times 1273 \times 10^{-6}}$$

$$= \underline{\underline{0.098 \text{ V}/\text{m}}}$$

Prob. 13.11

$$(a) \lambda = \frac{c}{f} = \frac{3 \times 10^8}{100 \times 10^6} = 3\text{m}$$

$$E_{\max} = \frac{\eta \pi I_o S}{r \lambda^2} \longrightarrow I_o = \frac{E_{\max} r \lambda^2}{\eta \pi S}$$

$$I_o = \frac{50 \times 10^{-3} \times 3 \times 3^2}{120 \eta^2 \pi (0.2)^2 100} = 90.71 \mu\text{A}$$

$$(b) R_{rad} = \frac{320\pi^4 S}{\lambda^4} = 320\pi^4 \pi^2 (0.2) \times 10^4 = 60.77 \text{ k}\Omega$$

$$P_{rad} = \frac{1}{2} I_0^2 R_{rad} = \frac{1}{2} (90.71)^2 \times 10^{-12} \times 60.77 \times 10^3$$

$$= \underline{0.25 \text{ mW}}$$

Prob. 13.12

$$(a) f(\theta) = \left| \frac{\cos\left(\frac{\pi}{2} \cos\theta\right)}{\sin\theta} \right|$$

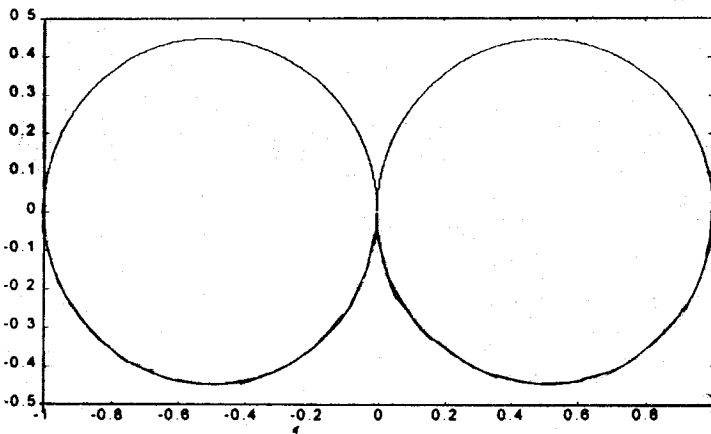

(b) The same as for $\frac{\lambda}{2}$ dipole except that the fields are zero for $\theta = \frac{\pi}{2}$ as shown.

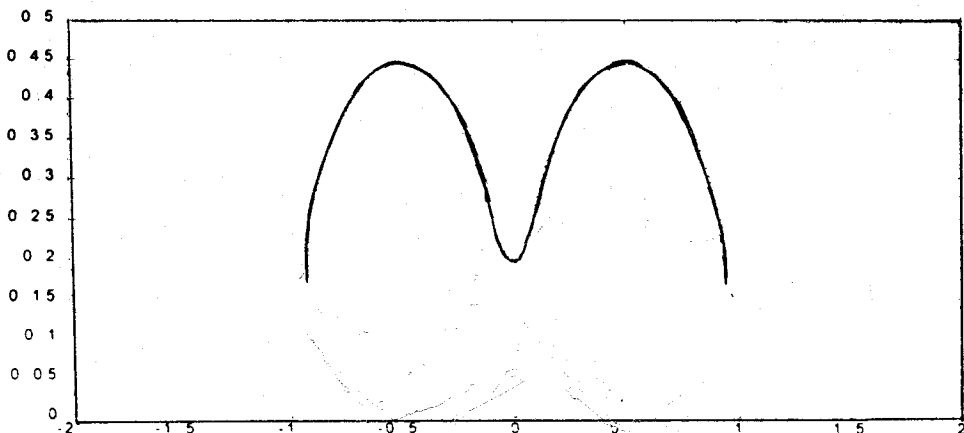

Prob. 13.13

For $l = 3\lambda/2$ and $l = \lambda$, the plots are the upper portions of those in Prob. 13.8(b). For $l = 5\lambda/8$, the plot is as shown below.

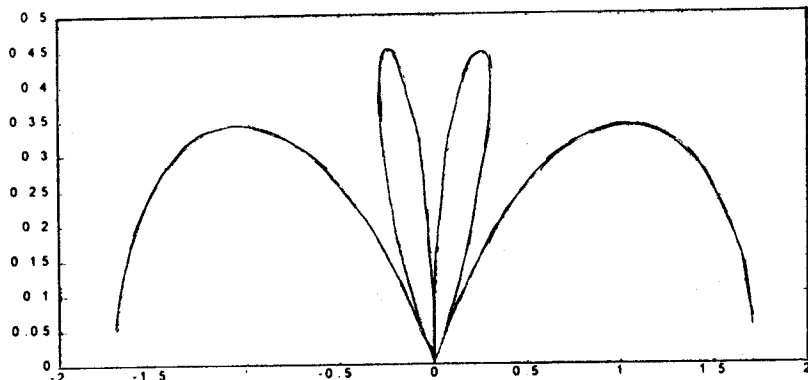
**Prob. 13.14**

$$P_{ave} = \frac{|E_s|^2}{2\eta} a_r = \frac{25 \sin^2 2\theta}{2\eta r^2} a_r$$

$$P_{rad} = \frac{25}{2\eta} \iint (2 \sin\theta \cos\theta)^2 \sin\theta d\theta d\phi$$

$$P_{rad} = \frac{25}{240\pi} (2\pi) \int_0^\pi 4 \sin^2\theta \cos^2\theta d(-\cos\theta)$$

$$= \frac{25}{120} \int_0^\pi (\cos^4\theta - \cos^2\theta) d(-\cos\theta)$$

$$= \frac{25}{120} \left(\frac{\cos^5\theta}{5} - \frac{\cos^3\theta}{3} \right) \Big|_0^\pi = \frac{25}{120} \left(-\frac{2}{5} + \frac{2}{3} \right)$$

$$P_{rad} = \underline{\underline{55.55 \text{ mW}}}$$

Prob. 13.15

$$f(\theta) = |\cos\theta \cos\phi|$$

For the vertical pattern, $\phi = 0$ \longrightarrow

$f(\theta) = |\cos\theta|$ which is sketched below.

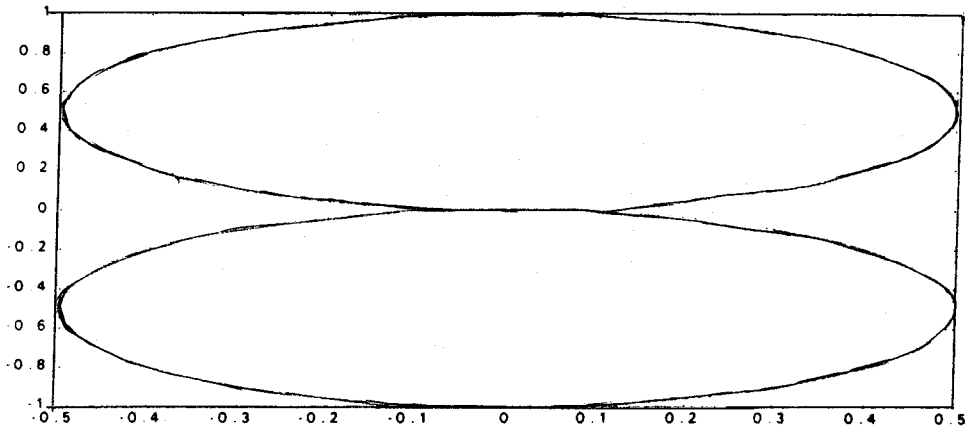
**Prob. 13.16**

$$P_{rad} = \frac{I_o^2 \eta \beta^2}{32\pi^2} (2\pi) \frac{4}{3} = \frac{I_o^2 \eta \beta^2 (dl)^2}{12\pi}$$

$$P_{ave} = \frac{I_o^2 \eta \beta^2 (dl)^2 \sin^2 \theta}{32\pi^2 r^2}$$

$$\frac{P_{ave}}{P_{rad}} = \frac{\sin^2 \theta}{32\pi^2 r^2} 12\pi = \frac{1.5 \sin^2 \theta}{4\pi r^2}$$

$$P_{ave} = \frac{1.5 \sin^2 \theta}{4\pi r^2} P_{rad}$$

Prob. 13.17

$$G_d = \frac{U}{U_{ave}} = \frac{4\pi r^2 P_{ave}}{\int P_{ave} \cdot dS} = \frac{8\pi \sin \theta \cos \phi}{\int P_{ave} \cdot dS}$$

$$\text{But } \int P_{ave} \cdot dS = \int_{\theta=0}^{\pi} \int_{\phi=0}^{\pi/2} 2 \sin \theta \cos \phi \sin \theta \, d\theta \, d\phi$$

$$= 2 \int_0^{\pi/2} \cos \phi \, d\phi \int_0^{\pi} \sin^2 \theta \, d\theta = 2 \sin \phi \bigg|_0^{\pi/2} \left(\frac{\pi}{2} \right) = \pi$$

$$G_d = \underline{\underline{8 \sin \theta \cos \phi}}$$

Prob. 13.18

$$\text{From Prob. 13.8, } E_{\theta_s} = \frac{j\eta I_0 e^{-j\beta r} \left[\cos\left(\frac{\beta l}{2} \cos\theta\right) - \cos\frac{\beta l}{2} \right]}{2\pi r \sin\theta}$$

$$\text{For } l = \lambda, \frac{\beta l}{2} = \frac{2\pi}{\lambda} \cdot \frac{\lambda}{2} = \pi$$

$$|E_{\theta_s}| = \frac{\eta I_0 [\cos(\pi \cos\theta) + 1]}{2\pi r \cos\theta}$$

$$f(\theta) = \frac{|E_{\theta_s}|}{|E_{\theta_s}|_{\max}} = \frac{\cos(\pi \cos\theta) + 1}{\sin\theta}$$

It is sketched below.

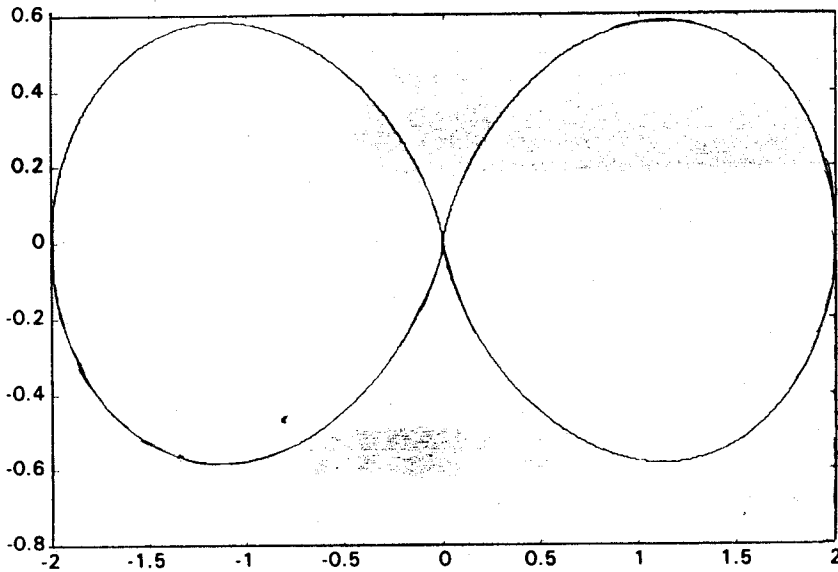
**Prob. 13.19**

$$(a) E_{\theta_s} = \frac{j\eta I_0 \beta dl}{4\pi r} \sin\theta e^{-j\beta r}$$

$$R_{rad} = 80\pi^2 \left(\frac{dl}{\lambda}\right)^2$$

$$G_{\phi} = \frac{4\pi r^2 P_{ave}}{P_{rad}} = \frac{4\pi r^2 \cdot \frac{1}{2\eta} |E_{\theta s}|^2}{\frac{1}{2} I_o^2 R_{rad}}$$

$$= \frac{4\pi r^2}{I_o^2} \cdot \frac{1}{80\pi^2} \left(\frac{\lambda}{dl}\right)^2 \cdot \frac{1}{\eta} \frac{\eta^2 I_o^2 \beta^2 (dl)^2 \sin^2 \theta}{16\pi^2 r^2}$$

$$G_{\phi} = \underline{\underline{1.5 \sin^2 \theta}}$$

$$(b) D = G_{\phi, \max} = \underline{\underline{1.5}}$$

$$(c) A_e = \frac{\lambda^2}{4\pi} G_{\phi} = \underline{\underline{\frac{1.5\lambda^2 \sin^2 \theta}{4\pi}}}$$

$$(d) R_{rad} = 80\pi^2 \left(\frac{1}{16}\right)^2 = \underline{\underline{3.084}}$$

Prob. 13.20

$$(a) E_{\phi s} = \frac{120\pi^2 I_o S}{r \lambda^2} \sin \theta e^{-\beta r}$$

$$R_{rad} = \frac{320\pi^4 S^2}{\lambda^4}$$

$$G_d = \frac{4\pi U(\theta, \phi)}{P_{rad}} = \frac{4\pi r^2 P_{ave}}{\frac{1}{2} I_o R_{rad}} = \frac{8\pi r^2}{I_o^2} \cdot \frac{1}{2\eta} \frac{|E_{\phi s}|^2}{R_{rad}}$$

$$= \frac{8\pi r^2}{I_o^2} \cdot \frac{1}{2\eta} \cdot 14400\pi^4 \frac{I_o^2 S^2}{r^2 \lambda^4} \sin^2 \theta \frac{\lambda^2}{320\pi^4 S^2}$$

$$G_d = \underline{\underline{1.5 \sin^2 \theta}}$$

$$(b) \underline{\underline{D = 1.5}}$$

$$(c) A_e = \frac{\lambda^2 G_d}{4\pi} = \underline{\underline{\frac{\lambda^2}{4\pi} 1.5 \sin^2 \theta}}$$

$$(d) S = \pi a^2 = \frac{\pi d^2}{4} = \frac{320\pi^6}{(576)^2}$$

$$R_{rad} = \underline{\underline{0.927\Omega}}$$

Prob. 13.21

$$R_{ac} = \frac{l}{\sigma S}, \quad S = \pi a^2$$

$$R_{ac} = \frac{l}{\sigma \pi a^2}$$

$$R_l = R_{ac} = \frac{a}{2\delta} R_{dc} = \frac{a}{2\delta} \frac{l}{\sigma \pi a^2}$$

$$\text{Now } \delta = \sqrt{\frac{\pi f \mu}{\sigma}} = \sqrt{\frac{\pi \times 15 \times 10^6 \times 4\pi \times 10^{-7}}{5.8 \times 10^7}} = 1.01 \times 10^{-3} \text{ m}$$

Alternatively, since $\delta \ll a$, current is confined to a cylindrical shell of thickness δ . Hence

$$R_l = R_{ac} = \frac{l}{\sigma (2\pi a)\delta}$$

$$l = \frac{\lambda}{2} = \frac{c}{2f} = \frac{3 \times 10^8}{2 \times 15 \times 10^6} = 10 \text{ m}$$

$$R_l = \frac{10}{2 \times 1.01 \times 5.8 \times 10^7 \times \pi \times 1.3 \times 10^{-2}} = 0.0209 \Omega$$

$$R_{rad} = 73 \Omega$$

$$\eta_r = \frac{R_{rad}}{R_{rad} + R_l} = \frac{73}{73.0209} = \underline{\underline{99.97\%}}$$

Prob. 13.22

$$(a) U_{\max} = 1$$

$$U_{ave} = \frac{P_{rad}}{4\pi} = \frac{\int u d\Omega}{4\pi}$$

$$= \frac{l}{4\pi} \int \int \sin^2 2\theta \sin \theta d\theta d\phi$$

$$= \frac{l}{4\pi} (2\pi) \int_0^\pi (2 \sin \theta \cos \theta)^2 d(-\cos \theta)$$

$$= 2 \int_0^\pi (\cos^4 \theta - \cos^2 \theta) d(\cos \theta)$$

$$= 2 \left[\frac{\cos^5 \theta}{5} - \frac{\cos^3 \theta}{3} \right]_0^{\pi}$$

$$= 2 \left[-\frac{2}{5} + \frac{2}{3} \right] = \frac{8}{15}$$

$$U_{ave} = \underline{0.5333}$$

$$D = \frac{U_{max}}{U_{ave}} = \underline{1.875}$$

(b) $U_{max} = 4$

$$U_{ave} = \frac{1}{4\pi} \int u d\Omega = \frac{4}{4\pi} \iint \frac{1}{\sin^2 \theta} d\theta d\phi$$

$$= \frac{1}{\pi} \int_0^{\pi} d\phi \int_{\pi/3}^{\pi/2} \frac{d(-\cos\theta)}{1 - \cos^2 \theta} = \frac{\pi}{\pi} \int \frac{dv}{u^2 - 1} = \ln \frac{1-u}{1+u} \Big|_{\pi/3}^{\pi/2}$$

$$= \ln 1 - \ln \frac{0.5}{1.5} = \ln 3$$

$$U_{ave} = \underline{1.099}$$

$$D = \frac{U_{max}}{U_{ave}} = \frac{4}{1.099} = \underline{3.641}$$

(c) $U_{max} = 2$

$$U_{ave} = \frac{1}{4\pi} \int u d\Omega = \frac{1}{4\pi} \iint 2 \sin^2 \theta \sin^2 \phi \sin \theta d\theta d\phi$$

$$= \frac{1}{2\pi} \int_0^{\pi} \sin^2 \phi d\phi \int_0^{\pi} (1 - \cos^2 \theta) d(-\cos\theta)$$

$$= \frac{1}{2\pi} \cdot \frac{\pi}{2} \left(\frac{\cos^3 \theta}{3} - \cos\theta \right) \Big|_0^{\pi} = \frac{1}{4} \left[-\frac{2}{3} + 2 \right] = \frac{1}{3}$$

$$U_{ave} = \underline{0.333}$$

$$D = \frac{U_{max}}{U_{ave}} = \underline{6}$$

Prob. 13.23

$$\begin{aligned}
 \text{(a)} \quad U_{ave} &= \frac{1}{4\pi} \int u d\Omega \\
 &= \frac{1}{4\pi} \int \int \sin^2 \theta \sin^2 \phi \sin \theta d\theta d\phi \\
 &= \frac{1}{2} \left(\frac{\cos^3 \theta}{3} - \cos \theta \right) \Big|_0^\pi = \frac{1}{2} \left(-\frac{2}{3} + 2 \right) = \frac{1}{2} \cdot \frac{4}{3} = \frac{2}{3}
 \end{aligned}$$

$$U_{ave} = 0.6667$$

$$G_\phi = \frac{U}{U_{ave}} = \underline{\underline{1.5 \sin^2 \theta}}$$

$$D = G_{\phi, \max} = \underline{\underline{1.5}}$$

$$\begin{aligned}
 \text{(b)} \quad U_{ave} &= \frac{1}{4\pi} \int \int 4 \sin^2 \theta \cos^2 \phi \sin \theta d\theta d\phi \\
 &= \frac{1}{\pi} \int_0^\pi \cos^2 \phi d\phi \int_0^\pi (1 - \cos^2 \theta) d(-\cos \theta) \\
 &= \frac{1}{\pi} \int_0^\pi \frac{1}{2} (1 - \cos 2\phi) d\phi \left(\frac{\cos^3 \theta}{3} - \cos \theta \right) \Big|_0^\pi \\
 &= \frac{1}{2\pi} \left(\phi + \frac{\sin 2\phi}{2} \right) \Big|_0^\pi \left(\frac{4}{3} \right) \\
 &= \frac{1}{2\pi} (\pi) \left(\frac{4}{3} \right) = \frac{2}{3}
 \end{aligned}$$

$$U_{ave} = 0.6667$$

$$G_{d, \max} = \frac{U}{U_{ave}} = \underline{\underline{6 \sin^2 \theta \cos^2 \phi}}$$

$$D = G_{d, \max} = \underline{\underline{6}}$$

$$\text{(c)} \quad U_{ave} = \frac{10}{4\pi} \int \int \cos^2 \theta \sin^2 \frac{\phi}{2} \sin \theta d\theta d\phi$$

$$\begin{aligned}
 &= \frac{10}{4\pi} \int_0^{\pi/2} \sin^2 \phi \frac{d\phi}{2} \int_0^\pi (\cos^2 \theta) d(-\cos \theta) \\
 &= \frac{10}{4\pi} \int_0^{\pi/2} \frac{1}{2} (1 - \cos^2 \phi) d\phi \left(-\frac{\cos^3 \theta}{3} \right) \Big|_0^\pi \\
 &= \frac{10}{4\pi} \left(\frac{2}{3} \right) \left(\frac{1}{2} \right) (\phi + \sin^2 \phi) \Big|_0^{\pi/2} = \frac{10}{12\pi} \left(\frac{\pi}{2} - 1 \right)
 \end{aligned}$$

$$U_{ave} = 0.1514$$

$$G_{d,max} = \frac{U}{U_{ave}} = \underline{\underline{66.05 \cos^2 \theta \cos^2 \frac{\phi}{2}}}$$

$$D = G_{d,max} = \underline{\underline{66.05}}$$

Prob. 13.24

$$\begin{aligned}
 \text{(a)} \quad P_{rad} &= \int P_{ave} \cdot dS = \frac{1}{2\eta} \int |E_{\phi s}|^2 \partial S \\
 &= \frac{0.04}{16\pi^2} \left(\frac{1}{2\pi} \right) \iint \frac{\cos^4 \theta}{r^2} r^2 \sin \theta d\theta d\phi \\
 &= \frac{0.04}{16\pi^2} \left(\frac{1}{240\pi} \right) (2\pi) \int_0^\pi \cos \theta d(-\cos \theta) \cdot 10^6 \\
 &= \frac{0.04}{16\pi^2} \frac{10^6}{120} \left(-\frac{\cos^3 \theta}{3} \right) \Big|_0^\pi = \frac{10^4}{480\pi^2} \cdot \frac{2}{5}
 \end{aligned}$$

$$P_{rad} = \underline{\underline{0.8443 \text{ W}}}$$

$$\begin{aligned}
 \text{(b)} \quad G_d &= \frac{4\pi U(\theta, \phi)}{P_{rad}} = \frac{4\pi r^2 P_{ave}}{P_{rad}} \\
 &= 4\pi r^2 \cdot \frac{0.04 \cos^4 \theta}{16\pi^2 r^2} \cdot \frac{10^6}{240\pi} \cdot \frac{12\pi^2}{100}
 \end{aligned}$$

$$G_d = 5 \cos^4 \theta$$

$$\text{Since } \cos 60^\circ = 1/2,$$

$$G_d = 5 \left(\frac{1}{2} \right)^4 = \underline{\underline{0.625}}$$

Prob. 13.25

This is similar to Fig. 13.10 except that the elements are z-directed.

$$E_s = E_{s1} + E_{s2} = \frac{j\eta\beta I_0 dl}{4\pi} \left[\sin\theta_1 \frac{e^{-j\beta r_1}}{r_1} a_{\theta 1} + \sin\theta_2 \frac{e^{-j\beta r_2}}{r_2} a_{\theta 2} \right]$$

where $r_1 \cong r - \frac{d}{2} \cos\theta$, $r_2 \cong r + \frac{d}{2} \cos\theta$, $\theta_1 \cong \theta_2 \cong \theta$, $a_{\theta 1} \cong a_{\theta 2} = a_\theta$

$$E_s = \frac{j\eta\beta I_0 dl}{4\pi} \sin\theta a_\theta [e^{j\beta d \cos\theta/2} + e^{-j\beta d \cos\theta/2}]$$

$$\underline{\underline{E_s = \frac{j\eta\beta I_0 dl}{4\pi} \sin\theta \cos\left(\frac{1}{2}\beta d \cos\theta\right) a_\theta}}$$

Prob. 13.26

$$(a) \text{ AF} = 2 \cos \left[\frac{1}{2} (\beta d \cos\theta + \alpha) \right], \quad \alpha = 0, \quad \beta d = \frac{2\pi}{\lambda} \lambda = 2\pi$$

$$\text{AF} = \underline{\underline{2 \cos(\pi \cos\theta)}}$$

(b) Nulls occur when

$$\cos(\pi \cos\theta) = 0 \quad \longrightarrow \quad \pi \cos\theta = \pm \pi/2, \pm 3\pi/2, \dots$$

or

$$\theta = \underline{\underline{60^\circ, 120^\circ}}$$

(c) Maxima and minima occur when

$$\frac{df}{d\theta} = 0 \quad \longrightarrow \quad \sin(\pi \cos\theta) \pi \sin\theta = 0$$

$$\text{i.e. } \sin\theta = 0 \quad \longrightarrow \quad \theta = 0^\circ, 180^\circ$$

$$\cos\theta = 0 \quad \longrightarrow \quad \theta = 90^\circ$$

or

$$\theta = \underline{\underline{0^\circ, 90^\circ, 180^\circ}}$$

(d) The group pattern is sketched below.

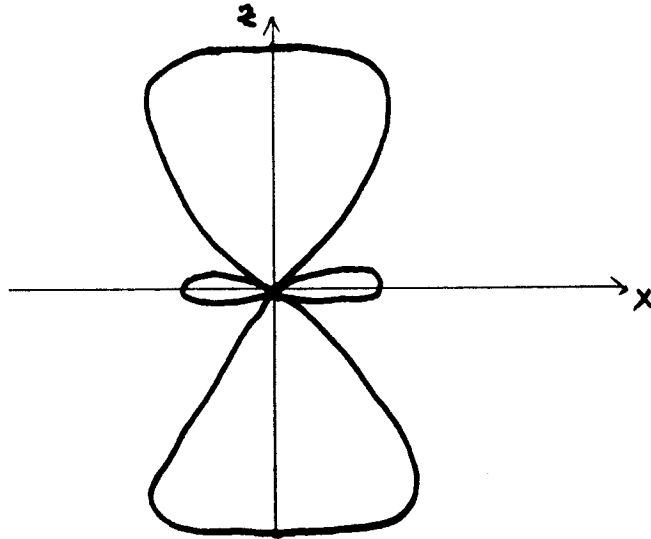

Prob. 13.27

(a) The group pattern is

$$f(\theta) = \cos \left[\frac{1}{2} (\beta d \cos \theta + \alpha) \right]$$

$$f(\theta) = \cos \left[\frac{1}{2} \left(\frac{2\pi}{\lambda} \cdot \frac{\lambda}{2} \cos \theta + \frac{\pi}{2} \right) \right]$$

$$= \cos \frac{\pi}{4} (\cos \theta + 1)$$

$$\cos \frac{\pi}{4} (\cos \theta + 1) = 0 \longrightarrow \frac{\pi}{4} (\cos \theta + 1) = \pm \frac{\pi}{2}, \pm \frac{3\pi}{2}$$

$$\text{or } \cos \theta = -1 \longrightarrow \theta = \pi$$

Maximum and minimum occur when

$$\frac{d}{d\theta} \left[\cos \frac{\pi}{4} (\cos \theta + 1) \right] = 0$$

$$\sin \theta \sin \frac{\pi}{4} (1 + \cos \theta) = 0$$

$$\sin \theta = 0 \quad \theta = 0 \text{ or } \theta = 180^\circ$$

Alternatively $f(\theta)$ can be plotted using Matlab or Maple.

The group pattern is shown below.

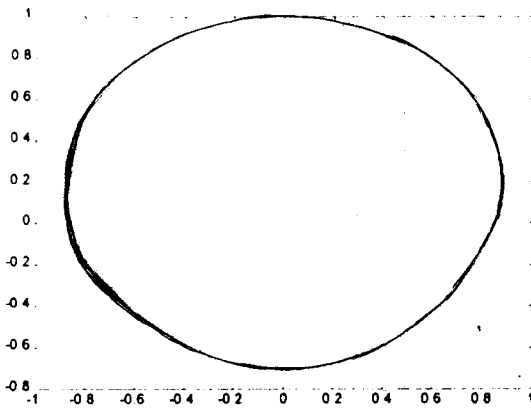

(b) For $d = \frac{\lambda}{2}$, $f(\theta) = \cos \left[\frac{1}{2} \left(\frac{2\pi}{\lambda} \cdot \frac{\lambda}{2} \cos\theta + \frac{\pi}{2} \right) \right]$

$$= \cos \left(\frac{\pi}{2} \cos\theta + \frac{\pi}{4} \right)$$

$$\cos \left(\frac{\pi}{2} \cos\theta + \frac{\pi}{4} \right) = 0 \longrightarrow \frac{\pi}{2} \cos\theta + \frac{\pi}{2} = \pm \frac{\pi}{2}, \pm \frac{3\pi}{2}$$

$$\cos\theta = \frac{1}{2} \longrightarrow \theta = 60^\circ$$

For maximum or minimum,

$$\frac{d}{d\theta} \left[\cos \frac{\pi}{2} \left(\cos\theta + \frac{\pi}{4} \right) \right] = 0$$

$$\sin\theta \sin \left(\frac{\pi}{2} \cos\theta + \frac{\pi}{4} \right) = 0$$

$$\sin\theta = 0 \longrightarrow \theta = 0^\circ, 180^\circ$$

$$\sin \left(\frac{\pi}{2} \cos\theta + \frac{\pi}{4} \right) = 0$$

$$\frac{\pi}{2} \cos\theta + \frac{\pi}{4} = 0 \longrightarrow \cos\theta = -\frac{1}{2} \longrightarrow \theta = 120^\circ$$

$$\left| \cos \left(\frac{\pi}{2} \cos\theta + \frac{\pi}{4} \right) \right| = 1 \longrightarrow \frac{\pi}{2} \cos\theta + \frac{\pi}{4} = 0, \pi, 2\pi \longrightarrow \theta = 120^\circ$$

The group pattern is sketched below.

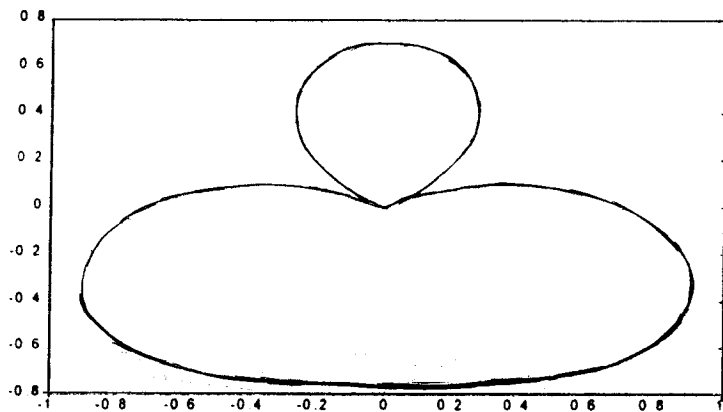
**Prob. 13.28**

$$f(\theta) = \cos \left[\frac{1}{2} (\beta d \cos \theta + \alpha) \right]$$

$$(a) \quad \alpha = \pi/2, \beta d = \frac{2\pi}{\lambda} \cdot \lambda = 2\pi$$

$$f(\theta) = \cos \left(\pi \cos \theta + \frac{\pi}{4} \right)$$

Nulls occur at $\pi \cos \theta + \frac{\pi}{4} = \pm \frac{\pi}{2}, \pm \frac{3\pi}{2}, \dots$ or $\theta = 75.5^\circ, 138.6^\circ$

Maxima occur at $\frac{\partial f}{\partial \theta} = 0 \longrightarrow \sin \theta = 0 \longrightarrow \theta = 0^\circ, 180^\circ$

Or $\sin \left(\pi \cos + \frac{\pi}{4} \right) = 0 \longrightarrow \theta = 41.4^\circ, 104.5^\circ$

With $f_{\max} = 0.71, 1$.

Hence the group pattern is sketched below.

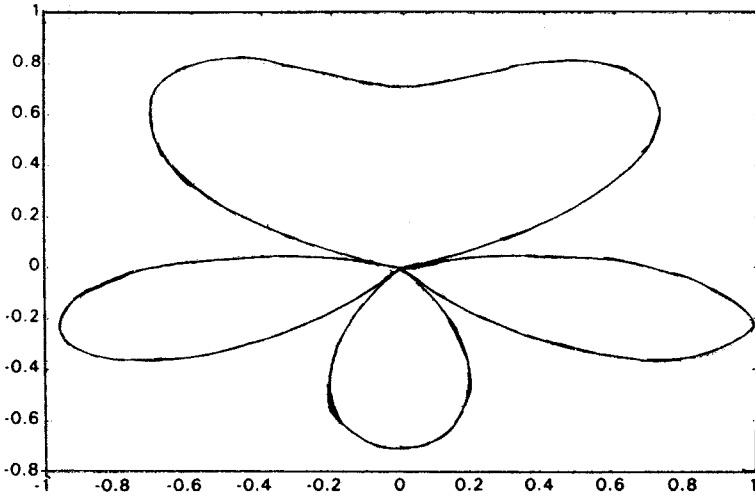

$$(b) \quad \alpha = \frac{3\pi}{4}, \beta d = \frac{2\pi}{\lambda} \cdot \frac{\lambda}{4} = \frac{\pi}{2}$$

$$f(\theta) = \left| \cos\left(\frac{\pi}{4}\cos\theta + \frac{3\pi}{8}\right) \right|$$

$$\text{Nulls occur at } \frac{\pi}{4}\cos\theta + \frac{3\pi}{8} = \pm\frac{\pi}{2}, \pm\frac{3\pi}{2}, \dots \longrightarrow \theta = 60^\circ$$

$$\text{Maxima and minima occur at } \sin\theta \sin\left(\frac{\pi}{4}\cos\theta + \frac{3\pi}{8}\right) = 0$$

$$\text{i.e. } \theta = 0^\circ, 180^\circ \rightarrow f(\theta) = 0.383, 0.924$$

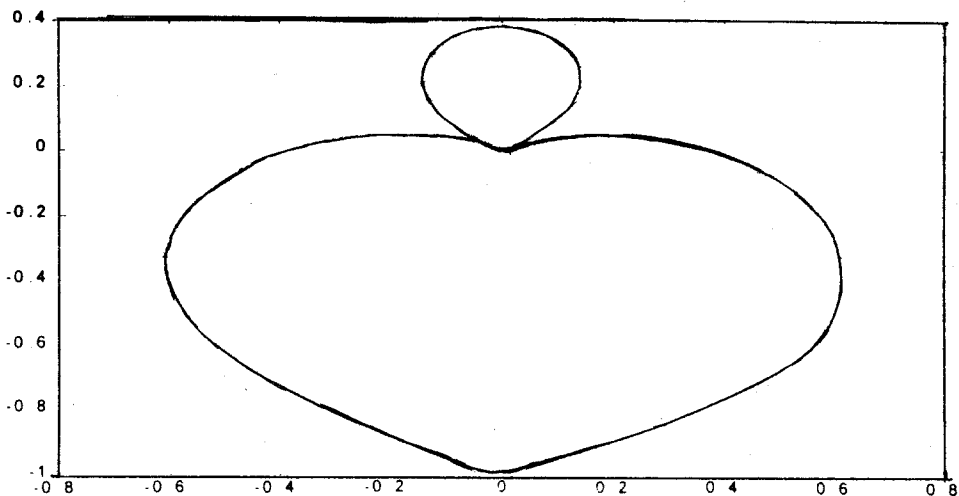

$$(c) \alpha = 0, \beta d = \frac{2\pi}{\lambda} \cdot \frac{3\lambda}{4} = \frac{3\pi}{2}$$

$$f(\theta) = \left| \cos\left(\frac{3\pi}{4} \cos\theta\right) \right|$$

It has nulls at $\frac{3\pi}{4} \cos\theta = \pm \frac{\pi}{2}, \pm \frac{3\pi}{2}, \dots \rightarrow \theta = 48.2^\circ, 131.8^\circ$

It has maxima and minima at $\frac{df}{d\theta} = 0 \rightarrow \sin\theta \sin\left(\frac{3\pi}{4} \cos\theta\right) = 0$

i.e. $\theta = 0^\circ, 180^\circ \rightarrow f(\theta) = 0.71, 1$

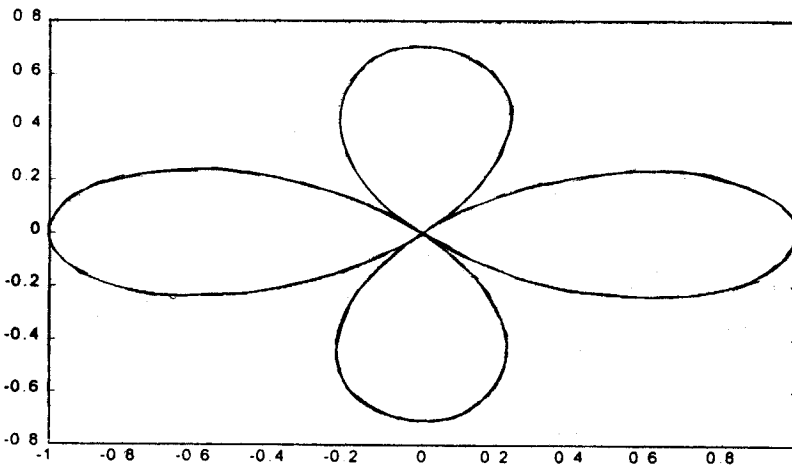

Prob. 13.29

$$(a) \text{ For } N=2, f(\theta) = \cos\left[\frac{1}{2}(\beta d \cos\theta + \alpha)\right]$$

$$\alpha = 0, d = \frac{\lambda}{4}$$

$$f(\theta) = \cos\left[\frac{1}{2}\left(\frac{2\pi}{\lambda} \cdot \frac{\lambda}{4} \cos\theta + 0\right)\right] = \cos\left(\frac{\pi}{4} \cos\theta\right)$$

Maxima and minima occur at

$$\frac{d}{d\theta} \left[\cos\left(\frac{\pi}{4} \cos\theta\right) \right] = 0$$

$$\sin\theta \sin\left(\frac{\pi}{4} \cos\theta\right) = 0$$

$$\sin\theta = 0 \rightarrow \theta = \pi, 0 \text{ and } f(\theta) = 0.707$$

$$\sin\left(\frac{\pi}{4} \cos\theta\right) \rightarrow \cos = 0 \rightarrow \theta = 90^\circ, f(\theta) = 1$$

Nulls occur as $\frac{\pi}{4} \cos\theta = \pm \frac{\pi}{2}, \pm \frac{3\pi}{2}, \dots$ (No Solution)

The group pattern is sketched below.

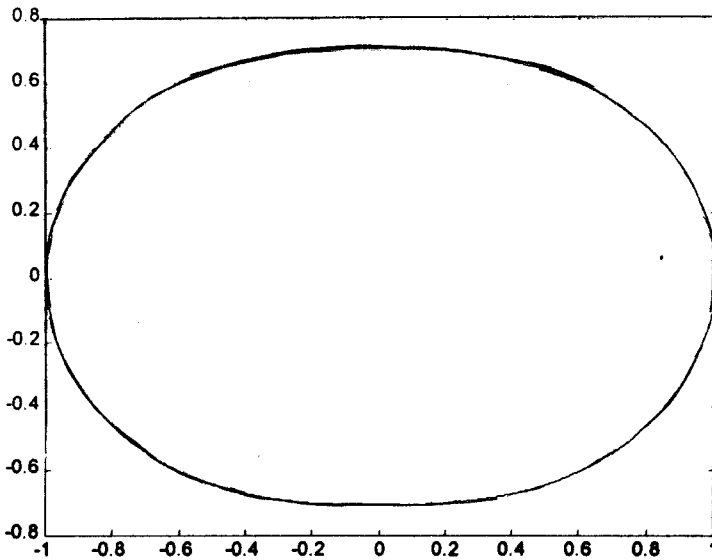

(b) For $N = 4$,

$$AF = \frac{\sin 2(\beta d \cos\theta + 0)}{\sin \frac{1}{2}(\beta d \cos\theta + 0)}$$

$$\text{Now, } \frac{\sin 4\theta}{\sin \theta} = \frac{2 \sin 2\theta \cos 2\theta}{\sin \theta} = 4 \cos 2\theta \cos \theta$$

$$AF = 4 \cos(\beta d \cos\theta) \cos\left(\frac{1}{2} \beta d \cos\theta\right)$$

$$f(\theta) = \cos\left(\frac{2\pi}{\lambda} \cdot \frac{\lambda}{4} \cos\theta\right) \cos\left(\frac{1}{2} \frac{2\pi}{\lambda} \cdot \frac{\lambda}{4} \cos\theta\right)$$

$$= \cos\left(\frac{\pi}{2} \cos\theta\right) \cos\left(\frac{\pi}{4} \cos\theta\right)$$

The plot is shown below.

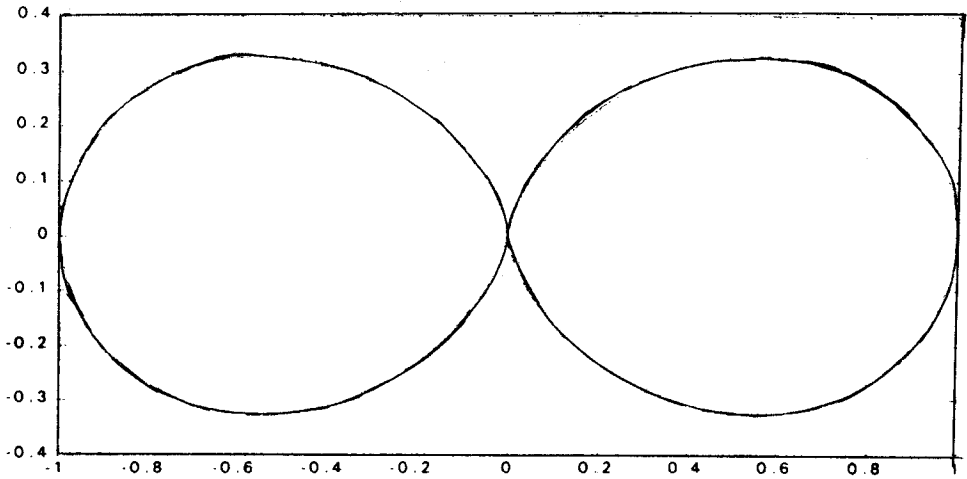

Prob. 13.30

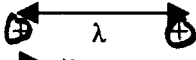
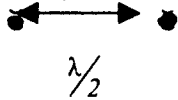
- (a) The given array is replaced by  where + represents 

Thus the resultant pattern is obtained as follows.

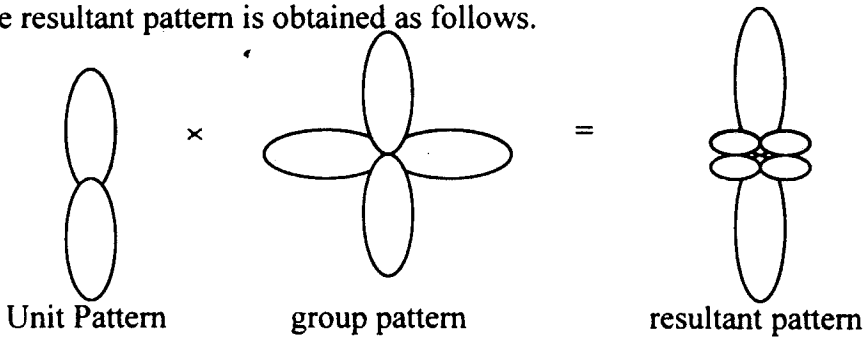

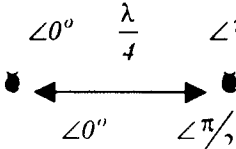
- (b) The array is replaced by  where + stands for 

Thus the resultant pattern is obtained as shown.

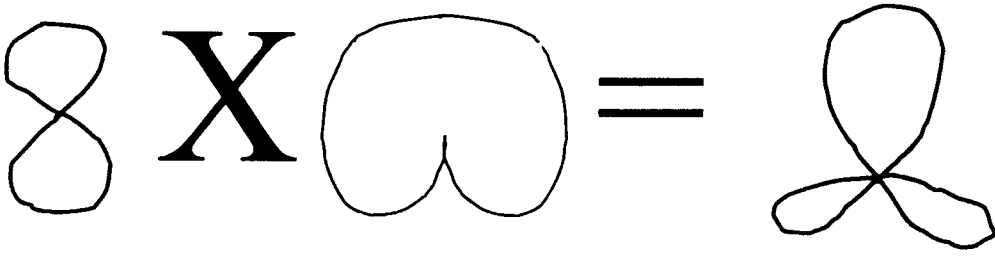

Prob. 13.31

$$A_e = \frac{\lambda^2}{4\pi} G_d$$

$$\text{where } G_d = \frac{4\pi u}{U_{ave}} = \frac{4\pi U}{\Gamma_{rad}}$$

$$\text{But } E_{\phi s} = \frac{\eta \pi I_o S}{r \lambda^2} \sin \theta e^{-\beta r}$$

$$U = r^2 P_{ave} = \frac{r^2 |E_{\phi s}|^2}{2\eta} = \frac{\eta \pi^2 I_o^2 S^2 \sin^2 \theta}{\lambda^4}$$

$$P_{rad} = \int P_{ave} dS = \frac{\eta \pi^2 I_o^2 S^2}{\lambda^4} \iint \sin^3 \theta \theta d\theta d\phi$$

$$= \frac{\eta \pi^2 I_o^2 S^2}{\lambda^4} \cdot (2\pi) \left(\frac{4}{3} \right)$$

$$G_d = 4\pi \frac{\frac{\eta \pi^2 I_o^2 S^2 \sin^2 \theta}{\lambda^4}}{\frac{\eta \pi^2 I_o^2 S^2}{\lambda^4} \cdot \frac{8\pi}{3}} = \frac{3}{2} \sin^2 \theta$$

$$\lambda = \frac{c}{f} = \frac{3 \times 10^8}{10^8} = 3m,$$

$$A_e = \frac{3\lambda^2}{8\pi} \sin^2 \theta = \frac{3 \times 9}{8\pi} \left(\frac{1}{2} \right)^2 = \underline{\underline{0.2686}}$$

Prob. 13.32

$$A_e = \frac{P_r}{P_{ave}} = \frac{P_r}{E_r/2\eta} = \frac{2\eta P_r}{E_r}$$

$$= \frac{2 \times 120\pi \times 2 \times 10^{-6}}{25 \times 10^2 \times 10^{-6}} = \frac{48\pi}{250} = \underline{\underline{0.6031}}$$

Prob. 13.33

$$(a) \quad A_{cr} = \frac{\lambda^2}{4\pi} G_{dr}, \quad A_{ct} = \frac{\lambda^2}{4\pi} G_{dt}$$

$$P_r = G_{dr} G_{dt} \left(\frac{\lambda^2}{4\pi r} \right) P_t = \left(\frac{4\pi}{\lambda^2} A_{er} \right) \left(\frac{4\pi}{\lambda^2} A_{et} \right) \left(\frac{\lambda^2}{4\pi r} \right) P_t$$

$$\text{or } \frac{P_r}{P_t} = \frac{i\lambda_{er} A_{et}}{\lambda^2 r^2}$$

$$(b) \quad P_{r,\max} = \frac{A_{cr} A_{ct}}{\lambda^2 r^2} P_t, \quad A_{cr} = A_{ct} = \frac{\lambda^2}{4\pi} (1.68)$$

$$\lambda = \frac{c}{f} = \frac{3 \times 10^8}{100 \times 10^6} = 3m,$$

$$P_{r,\max} = \frac{(0.13\lambda^2)^2 (80)}{\lambda^2 (10^3)^2} = \underline{\underline{12.8 \mu W}}$$

Prob. 13.34

$$P_r = P_t A_e = P_t \frac{\lambda^2}{4\pi} G_d$$

$$P_{r,\max} = P_t \frac{\lambda^2}{4\pi} G_{d,\max}$$

But $G_{d,\max} = D = 1.64$ and

$$P_t = \frac{E^2}{2\eta}, \quad \lambda = \frac{c}{f} = \frac{3 \times 10^8}{60 \times 10^6} = 5m$$

$$P_{r,\max} = \frac{E^2 \lambda^2 D}{8\pi\eta} = \frac{9 \times 10^{-6} \times 25 \times 1.64}{8\pi(120\pi)}$$

$$= \underline{\underline{38.9 \text{ nW}}}$$

Prob. 13.35

$$G_{dt} = 10^4, G_{dr} = 10^{3.2} = 1585$$

$$\lambda = \frac{c}{f} = \frac{3 \times 10^8}{15 \times 10^9} = 0.02 \text{ m} = \frac{1}{50}$$

$$P_r = G_{dr} G_{dt} \left(\frac{\lambda}{4\pi r} \right)^2 P_t = 10^4 (1585) \left(\frac{0.02}{4\pi \times 2.456741 \times 10^{-7}} \right)^2 320$$

$$= 2.128 \times 10^{-11} \text{ W} = \underline{\underline{21.28 \text{ pW}}}$$

Prob. 13.36

$$G_d = \frac{U}{U_{ave}} = \frac{4\pi r^2 P_{ave}}{P_{rad}} \text{ or } P_{ave} = \frac{G_d P_{rad}}{4\pi r^2}$$

$$G_d = 10^{3.4} = 2511.9$$

$$P_{ave} = \frac{2511.9 \times 7.5 \times 10^3}{4\pi (40 \times 10^3)^2}$$

$$= \underline{\underline{0.937 \text{ mW/m}^2}}$$

Prob. 13.37

$$30 \text{ dB} = \log \frac{P_t}{P_r} \rightarrow \frac{P_t}{P_r} = 10^3 = 1000$$

$$\text{But } P_r = (G_d)^2 \left(\frac{3}{50 \times 4\pi \times 12} \right)^2 P_t = P_t \left(\frac{G_d}{800\pi} \right)^2$$

$$\left(\frac{G_d}{800\pi} \right)^2 = \frac{P_r}{P_t} = \frac{1}{1000} = \left(\frac{1}{10\sqrt{10}} \right)^2$$

$$\text{or } G_d = \frac{800\pi}{10\sqrt{10}} = 79.476$$

$$G_d = 10 \log 79.476 = \underline{\underline{19 \text{ dB}}}$$

Prob. 13.38

$$G_{dt} = 25 = 10 \log_{10} G_d \rightarrow G_d = 10^{2.5} = 316.23$$

$$G_{dr} = 10^3 = 1000$$

$$P_r = 316.23 \times 10^3 \left(\frac{1}{4\pi \times 1.5 \times 10^3 \cdot 1.5 \times 10^9} \right) = \underline{\underline{7.12 \text{ mW}}}$$

Prob. 13.39

$$(a) P_i = \frac{|E|^2}{2\eta_0} = \frac{P_{rad} G_d}{4\pi r^2} \rightarrow |E_i| = \sqrt{\frac{240\pi P_{rad} G_d}{4\pi r^2}}$$

$$|E_i| = \frac{1}{r} \sqrt{60 P_{rad} G_d} = \frac{1}{120 \times 10^6} \sqrt{60 \times 200 \times 10^3 \times 3500}$$

$$= \underline{\underline{1.708 \text{ V/m}}}$$

$$(b) |E_s| = \sqrt{\frac{|E_i|^2 \sigma}{4\pi r^2}} = \sqrt{\frac{1.708^2 \times 8}{4\pi \times 14400 \times 10^6}} = \underline{\underline{11.36 \mu\text{V/m}}}$$

$$(c) P_c = P_i \sigma = \frac{1.708^2}{240\pi} (8) = \underline{\underline{30.95 \text{ mW}}}$$

$$(d) P_r = \frac{|E|^2}{2\eta_0} = \frac{(11.36)^2 \times 10^{-12}}{240\pi} = 1.712 \times 10^{-13} \text{ W/m}^2$$

$$\lambda = \frac{3 \times 10^8}{15 \times 10^8} = 0.2 \text{ m}, A_{2r} = \frac{\lambda^2 G}{4\pi} = \frac{0.04 \times 3500}{4\pi}$$

$$P_r = P_a A_{er} = 1.712 \times 10^{-13} \times 11.14 = 1.907 \times 10^{-12}$$

$$\text{or } P_r = \frac{(\lambda G_d)^2 \sigma P_{rad}}{(4\pi)^3 r^4} = \frac{(0.2 \times 3500)^2 \times 8 \times 2 \times 10^5}{(4\pi)^3 \times 12^4 \times 10^{16}}$$

$$= \underline{\underline{1.91 \times 10^{-12} \text{ W}}}$$

Prob. 13.40

$$\lambda = \frac{c}{f} = \frac{3 \times 10^8}{6 \times 10^6} = 0.5 \text{ m}$$

$$P_r = G_{dr} G_{dt} \left(\frac{\lambda}{4\pi r} \right)^2 P_t = (1)(1) \left(\frac{0.5}{4\pi \times 10^3} \right)^2 (80)$$

$$= \underline{\underline{0.1267 \mu\text{W}}}$$

Prob. 13.41

$$P_r = \frac{(\lambda G_d)^2 \sigma P_{rad}}{(4\pi)^3 r^4} \rightarrow P_{rad} = \frac{(4\pi)^3 r^4 P_r}{(\lambda G_d)^2 \sigma}$$

$$\lambda = \frac{c}{f} = \frac{3 \times 10^8}{6 \times 10^9} = \frac{1}{20} \ll (r = 250\text{m})$$

$$40 = \log_{10} G_d \rightarrow G_d = 10^4$$

$$P_{rad} = \frac{(4\pi)^3 (0.25 \times 10^3)^4 \times 2 \times 10^{-6}}{\left(\frac{1}{20} \times 10^4 \right)^2 \times 0.8} = \underline{\underline{7.52 \text{ W}}}$$

Prob. 13.42

$$P_{rad} = \frac{4\pi}{G_{dt} G_{dr}} \left(\frac{4\pi r_1 r_2}{\lambda} \right)^2 \frac{P_r}{\sigma}$$

$$\text{But } G_{dt} = 36\text{dB} = 10^{3.6} = 3981.1$$

$$G_{dr} = 20\text{dB} = 10^2 = 100$$

$$\lambda = \frac{c}{f} = \frac{3 \times 10^8}{5 \times 10^9} = 0.06$$

$$r_1 = 3\text{km}, r_2 = 5\text{km}$$

$$P_{rad} = \frac{4\pi}{3981.1 \times 100} \left(\frac{4\pi \times 15 \times 10^6}{6 \times 10^{-2}} \right)^2 \frac{8 \times 10^{-12}}{2.4}$$

$$= \underline{\underline{1.038 \text{ kW}}}$$

CHAPTER 14

P. E. 14.1

$$S_i = \frac{1 + 0.4}{1 - 0.4} = \frac{1.4}{0.6} = \underline{2.333}$$

$$S_o = \frac{1 + 0.2}{1 - 0.2} = \frac{1.2}{0.8} = \underline{1.5}$$

P. E. 14.2

(a) By Snell's law, $n_1 \sin \theta_1 = n_2 \sin \theta_2$. Thus

$$\theta_2 = 90^\circ \longrightarrow \sin \theta_2 = 1$$

$$\sin \theta_1 = n_2/n_1, \quad \theta_1 = \sin^{-1} n_2/n_1 = \sin^{-1} 1.465/1.48 = \underline{81.83^\circ}$$

$$(b) \text{ NA} = \sqrt{n_1^2 - n_2^2} = \sqrt{1.48^2 - 1.465^2} = \underline{0.21}$$

P. E. 14.3

$$\alpha l = 10 \log P(0)/P(l) = 0.2 \times 10 = 2$$

$$P(0)/P(l) = 10^{0.2}, \text{ i.e. } P(l) = P(0) 10^{-0.2} = 0.631 P(0)$$

i.e. 63.1%

Prob. 14.1 Microwave is used:

- (1) For surveying land with a piece of equipment called the *tellurometer*. This radar system can precisely measure the distance between two points.
- (2) For guidance. The guidance of missiles, the launching and homing guidance of space vehicles, and the control of ships are performed with the aid of microwaves
- (3) In semiconductor devices. A large number of new microwave semiconductor devices have been developed for the purpose of microwave oscillator, amplification, mixing/detection, frequency multiplication, and switching. Without such achievement, the majority of today's microwave systems could not exist.

Prob. 14.2 (a) In terms of the S-parameters, the T-parameters are given by

$$T_{11} = 1/S_{21}, \quad T_{12} = -S_{22}/S_{21}, \quad T_{21} = S_{11}/S_{21}, \quad T_{22} = S_{12} - S_{11} S_{22}/S_{21}$$

$$(b) \quad T_{11} = 1/0.4 = 2.5, \quad T_{12} = -0.2/0.4,$$

$$T_{21} = 0.2/0.4, \quad T_{22} = 0.4 - 0.2 \times 0.2/0.4 = 0.3$$

Hence,

$$\underline{\underline{T = \begin{bmatrix} 2.5 & 0.5 \\ -0.5 & 0.3 \end{bmatrix}}}$$

Prob. 14.3 Since $Z_L = Z_0$, $\Gamma_L = 0$.

$$\Gamma_i = S_{11} = \underline{0.33 - j0.15}$$

$$\Gamma_g = (Z_g - Z_0)/(Z_g + Z_0) = (2 - 1)/(2 + 1) = 1/3$$

$$\begin{aligned} \Gamma_o &= S_{22} + S_{12}S_{21}\Gamma_g / (1 - S_{11}\Gamma_g) \\ &= 0.44 - j0.62 + 0.56 \times 0.56 \times (1/3) / [1 - (0.11 - j0.05)] \\ &= \underline{0.5571 - j0.6266} \end{aligned}$$

Prob. 14.4 The microwave wavelengths are of the same magnitude as the circuit components. The wavelength in air at a microwave frequency of 300 GHz, for example, is 1 mm. The physical dimension of the lumped element must be in this range to avoid interference. Also, the leads connecting the lumped element probably have much more inductance and capacitance than is needed.

Prob. 14.5

$$\lambda = c/f = \frac{3 \times 10^8}{8.4 \times 10^9} = \underline{3.571 \text{ mm}}$$

Prob. 14.6

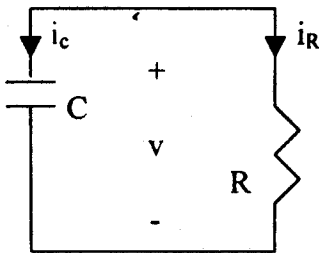

$$i_c + i_R = 0; \text{ hence } Cdv/dt + v/R = 0$$

$$\text{or } dv/v = - dt/RC$$

$$\text{so that } \ln v = -t/\tau + \ln v_0, \tau = RC = 125 \times 10^{-12} \times 2 \times 10^3 = 0.5 \mu\text{s}$$

$$v = v_0 e^{-t/\tau}, v(0) = v_0 = 1500$$

$$i_c = C \, dv/dt = C (-1/\tau) v_0 e^{-v/\tau} = \frac{-125 \times 10^{-12}}{0.5 \times 10^{-6}} \times 1500 e^{-v/\tau}$$

$$= \underline{\underline{-0.375 e^{-v/\tau} \text{ A}}}, \quad \underline{\underline{\tau = 0.5 \, \mu\text{s}}}$$

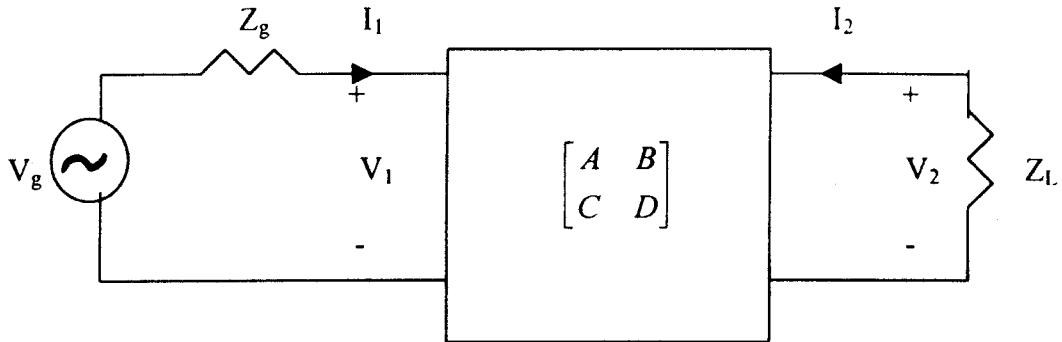
Prob. 14.7

By definition

$$V_1 = AV_2 - BI_2 \quad (1)$$

$$I_1 = CV_2 - DI_2 \quad (2)$$

We eliminate I_1 and I_2 .

$$V_g = V_1 + Z_g I_1 \quad \text{or} \quad I_1 = (V_g - V_1)/Z_g \quad (3)$$

$$V_2 = -Z_L I_2 \quad \text{or} \quad I_2 = -V_2/Z_L \quad (4)$$

Substituting (3) and (4) into (1) and (2) and expressing V_1 and V_2 in terms of V_g , we obtain

$$IL = 20 \log V_1/V_2 = 20 \log_{10} \left| \frac{AZ_L + B + CZ_g Z_L + DZ_g}{Z_g + Z_L} \right|$$

Prob. 14.8

$$(a) R_{dc} = \frac{l}{\sigma S} = \frac{10^3}{0.96 \times 10^{-4} \times 6.1 \times 10^7} = \underline{\underline{16.73 \text{ m}\Omega/\text{km}}}$$

$$(b) R_{ac} = \frac{l}{\delta w \sigma}, \quad \pi a^2 = 0.8 \times 1.2 = 0.96 \quad \text{or} \quad a = 0.5528$$

$$\delta = \frac{1}{\sqrt{\pi f \mu \sigma}} = \frac{1}{\sqrt{\pi \times 6 \times 10^6 \times 4\pi \times 10^{-7} \times 6.1 \times 10^7}} = \frac{1}{12\pi \times 10^3}$$

$$R_{ac} = \frac{1000 \times 12\pi \times 10^3}{1.2 \times 10^{-2} \times 6.1 \times 10^7} = \underline{\underline{51.5 \, \Omega}}$$

Prob. 14.9

$$n = c/u_m = \frac{3 \times 10^8}{2.1 \times 10^8} = \underline{1.428}$$

Prob. 14.10 When an optical fiber is used as the transmission medium, cable radiation is eliminated. Thus, optical fibers offer total EMI isolation because they neither emit nor pick up EM waves.

Prob. 14.11

$$(a) \text{ NA} = \sqrt{n_1^2 - n_2^2} = \sqrt{1.62^2 - 1.604^2} = \underline{0.2271}$$

$$(b) \text{ NA} = \sin \theta_a = 0.2271 \text{ or } \theta_a = \sin^{-1} 0.2271 = \underline{13.13^\circ}$$

$$(c) V = \frac{\pi d}{\lambda} \text{ NA} = \frac{\pi \times 50 \times 10^{-6} \times 0.2271}{1300 \times 10^{-9}} = 27.441$$

$$N = V^2/2 = \underline{376 \text{ modes}}$$

Prob. 14.12

$$(a) V = \frac{\pi d}{\lambda} \sqrt{n_1^2 - n_2^2} = \frac{\pi \times 2.5 \times 10^{-6} \times 2}{1.3 \times 10^{-6}} \sqrt{1.45^2 - 1^2} = \underline{12.69}$$

$$(b) \text{ NA} = \sqrt{n_1^2 - n_2^2} = \sqrt{1.45^2 - 1^2} = \underline{1.05}$$

$$(c) N = V^2/2 = \underline{80 \text{ modes}}$$

Prob. 14.13

$$(a) \text{ NA} = \sin \theta_a = \sqrt{n_1^2 - n_2^2} = \sqrt{1.53^2 - 1.45^2} = 0.4883$$

$$\theta_a = \sin^{-1} 0.4883 = \underline{29.23^\circ}$$

$$(b) P(l)/P(0) = 10^{-\alpha l / 10} = 10^{-0.4 \times 5 / 10} = 0.631$$

i.e. 63.1 %

Prob. 14.14

$$P(l) = P(0) e^{-\alpha l / 10} = 10 e^{-0.5 \times 0.85 / 10} \text{ mW} = \underline{9.584 \text{ mW}}$$

Prob. 14.15 As shown in Eq. (10.35), $\log_{10} P_1/P_2 = 0.434 \ln P_1/P_2$,

$$1 \text{ Np} = 20 \log_{10} e = 8.686 \text{ dB} \text{ or } 1 \text{ Np/km} = 8.686 \text{ dB/km.}$$

or $1\text{Np/m} = 8686\text{ dB/km}$. Thus,

$$\alpha_{10} = \underline{8686} \underline{\alpha}_{14}$$

Prob. 14.16

$$P(0) = P(l) e^{\alpha l/10} = 0.2 e^{0.4 \times 30/10} \text{ mW} = \underline{0.664 \text{ mW}}$$

Prob. 14.17 See text.

CHAPTER 15

P. E. 15.1 The program in Fig. 15.3 was used to obtain the plot in Fig. 15.5.

P. E. 15.2 For the exact solution,

$$(D^2 + 1)y = 0 \quad \rightarrow \quad y = A \cos x + B \sin x$$

$$y(0) = 0 \quad \rightarrow \quad A = 0$$

$$y(1) = 1 \quad \rightarrow \quad 1 = B \sin 1 \text{ or } B = 1/\sin 1$$

$$\text{Thus, } y = \sin x / \sin 1$$

For the finite difference solution,

$$y'' + y = 0 \quad \rightarrow \quad \frac{y(x + \Delta) - 2y(x) + y(x - \Delta)}{\Delta^2} + y = 0$$

or

$$y(x) = \frac{y(x + \Delta) + y(x - \Delta)}{2 - \Delta^2}, y(0) = 0, y(1) = 1, \Delta = 1/4$$

With the Fortran program shown below, we obtain the exact result y_e and FD result y .

```

DIMENSION
Y(0) = 0.0
Y(4) = 1.0
DEL = 0.25
DO 10 N = 1,20 ! N = NO. OF ITERATIONS
DO 10 I = 1,3
Y(I) = ( Y(I+1) + Y(I-1) ) / (2.0 - DEL*DEL)
X = FLOAT (I)*DEL
YE = SIN(X)/SIN(1.0)
PRINT *, N, I, Y(I), YE
10 CONTINUE
STOP
END

```

The results are listed below.

$y(x)$	N=5	N=10	N=15	N=20	Exact $y_e(x)$
$y(0.25)$	0.2498	0.2924	0.2942	0.2943	0.2941
$y(0.5)$	0.5242	0.5682	0.5701	0.5701	0.5697
$y(0.75)$	0.7867	0.8094	0.8104	0.8104	0.8101

P. E. 14.3 By applying eq. (15.16) to each node as shown below, we obtain the following results after 5 iterations.

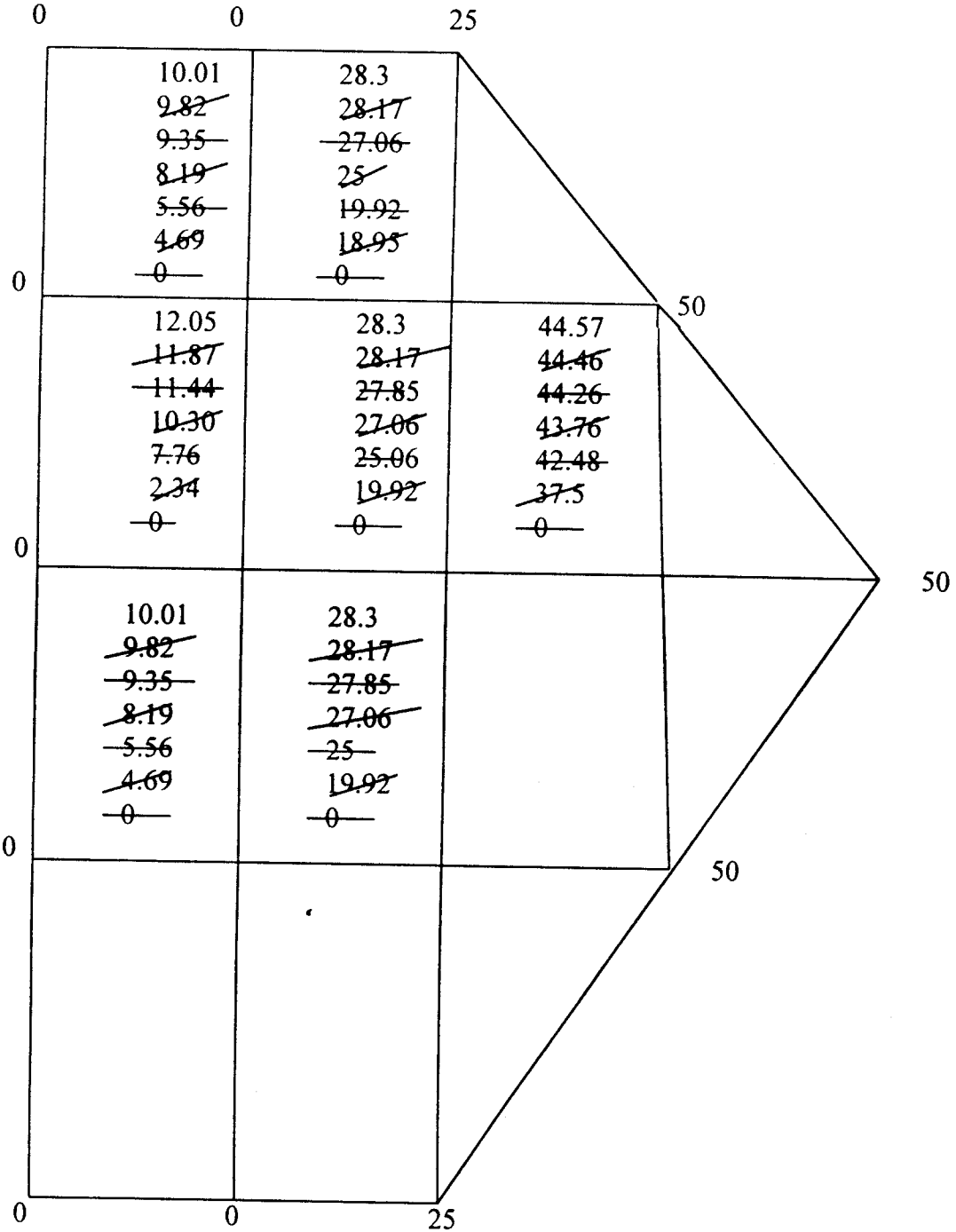

P. E. 15.4 (a) Using the program in Fig. 15.16 with $NX = 4$ and $NY = 8$, we obtain the potential at center as

$$V(2,4) = \underline{23.80 \text{ V}}$$

(b) Using the same program with $NX = 12$ and $NY = 24$, the potential at the center is

$$V(6,12) = \underline{23.89 \text{ V}}$$

P. E. 15.5 By combining the ideas in Figs. 15.21 and 15.25, and dividing each wire into N segments, the results listed in Table 14.2 is obtained.

P. E. 15.6

(a)

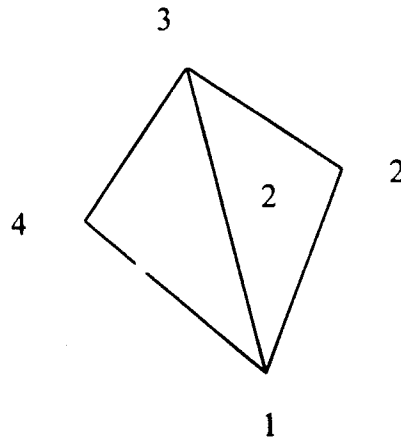

For element 1, local 1-2-3 corresponds with global 1-3-4 so that $A_1 = 0.35$,

$$P_1 = 0.8, P_2 = 0.6, P_3 = -1.4, Q_1 = -0.5, Q_2 = 0.5, Q_3 = 0$$

$$C^{(1)} = \begin{bmatrix} 0.6357 & 0.1643 & -0.8 \\ 0.1643 & 0.4357 & -0.6 \\ -0.8 & -0.6 & 1.4 \end{bmatrix}$$

For element 2, local 1-2-3 corresponds with global 1-2-3 so that $A_2 = 0.7$,

$$P_1 = 0.1, P_2 = 1.4, P_3 = -1.5, Q_1 = -1, Q_2 = 0, Q_3 = 1$$

$$C^{(2)} = \begin{bmatrix} 0.3607 & 0.05 & -0.4107 \\ 0.05 & 0.7 & -0.75 \\ -0.4107 & -0.75 & 1.1607 \end{bmatrix}$$

The global coefficient matrix is given by

$$C = \begin{bmatrix} C_{11}^{(1)} + C_{11}^{(2)} & C_{12}^{(2)} & C_{12}^{(1)} + C_{13}^{(2)} & C_{13}^{(1)} \\ C_{21}^{(2)} & C_{22}^{(2)} & C_{23}^{(2)} & 0 \\ C_{21}^{(1)} + C_{31}^{(2)} & C_{32}^{(2)} & C_{22}^{(1)} + C_{33}^{(2)} & C_{23}^{(1)} \\ C_{31}^{(1)} & 0 & C_{32}^{(2)} & C_{33}^{(1)} \end{bmatrix}$$

$$= \begin{bmatrix} 0.9964 & 0.05 & -0.2464 & -0.8 \\ 0.05 & 0.7 & 0.75 & 0 \\ -0.2464 & 0.75 & 1.596 & -0.6 \\ -0.8 & 0 & -0.6 & 1.4 \end{bmatrix}$$

(b)

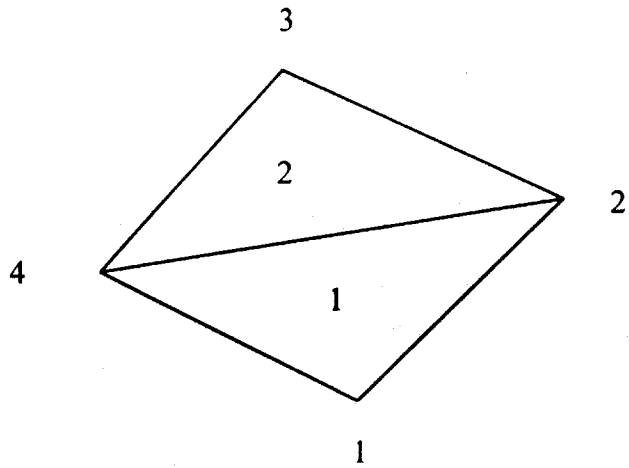

For element 1, local 1-2-3 corresponds with global 1-2-4 and $A_1 = 0.675$,

$$P_1 = 0.8, P_2 = -0.9, P_3 = 0.4, Q_1 = -0.5, Q_2 = 1.5, Q_3 = -1.0$$

$$C^{(2)} = \begin{bmatrix} 0.5933 & -0.9800 & 0.3867 \\ -0.9800 & 2.040 & -1.060 \\ 0.3867 & -1.060 & 0.6733 \end{bmatrix}$$

For element 2, local 1-2-3 corresponds with global 2-3-4 and $A_2 = 0.375$,

$$P_1 = 0.1, P_2 = 1.4, P_3 = -1.5, Q_1 = -1, Q_2 = 0, Q_3 = 1$$

$$C^{(1)} = \begin{bmatrix} 0.3607 & 0.05 & -0.4107 \\ 0.05 & 0.7 & -0.75 \\ -0.4107 & -0.75 & 1.1607 \end{bmatrix}$$

The global coefficient matrix is

$$C = \begin{bmatrix} C_{11}^{(1)} & C_{12}^{(1)} & 0 & C_{13}^{(1)} \\ C_{21}^{(1)} & C_{22}^{(1)} + C_{11}^{(2)} & C_{12}^{(2)} & C_{23}^{(1)} + C_{13}^{(2)} \\ 0 & C_{12}^{(2)} & C_{22}^{(2)} & C_{23}^{(2)} \\ C_{31}^{(1)} & C_{32}^{(1)} + C_{31}^{(2)} & C_{32}^{(2)} & C_{33}^{(1)} + C_{33}^{(2)} \end{bmatrix}$$

$$= \begin{bmatrix} 1.333 & -0.0777 & 0 & -1.056 \\ -0.0777 & 0.8192 & -0.98 & 0.2386 \\ 0 & -0.98 & 2.04 & -0.106 \\ -1.056 & 0.2386 & -1.06 & 1.877 \end{bmatrix}$$

P. E. 15.7 We use the FORTRAN program in Fig. 15.34. The input data for the region in Fig. 14.35 is as follows:

NE = 32; ND = 26; NP = 18;

NL = [1 2 5

2 4 5

2 3 5

3 6 5

4 5 9

5 10 9

5 6 10

6 11 10

7 8 12

8 13 12

8 9 13

9 14 13

9 10 14

10 15 15

10 11 14

11 16 15

12 13 17

13 18 17

13 14 18

14 19 18

14 15 19

15 20 19

15 16 20

16 21 20

17 18 22

18 23 22
 18 19 22
 19 24 23
 19 20 24
 20 25 24
 20 21 25
 21 26 25];

$X = [1.0\ 2.5\ 2.0\ 1.0\ 1.5\ 2.0\ 0.0\ 0.5\ 1.0\ 1.5\ 2.0\ 0.0\ 0.5\ 1.0\ 1.5\ 2.0\ 0.0\ 0.5\ 1.0\ 1.5\ 1.5\ 0.0\ 0.5\ 1.0\ 1.5\ 2.0];$

$Y = [0.0\ 0.0\ 0.0\ 0.5\ 0.5\ 0.5\ 1.0\ 1.0\ 1.0\ 1.0\ 1.0\ 1.5\ 1.5\ 1.5\ 1.5\ 1.5\ 2.0\ 2.0\ 2.0\ 2.0\ 2.0\ 2.5\ 2.5\ 2.5\ 2.5\ 2.5\ 2.5];$

$NDP = [1\ 2\ 3\ 6\ 11\ 16\ 21\ 26\ 25\ 24\ 23\ 22\ 17\ 12\ 7\ 8\ 9\ 4];$

$VAL = [0.0\ 0.0\ 15.0\ 30.0\ 30.0\ 30.0\ 30.0\ 30.0\ 30.0\ 20.0\ 20.0\ 20.0\ 10.0\ 0.0\ 0.0\ 0.0\ 0.0\ 0.0\ 0.0];$

With this data, the finite element (FEM) solution is compared with the finite difference (FD) solution as shown below.

Node #	x	y	FEM	FD
5	1.5	0.5	11.265	11.25
10	1.5	1.0	15.06	15.02
13	0.5	1.5	4.958	4.705
14	1.0	1.5	9.788	9.545
15	1.0	1.5	18.97	18.84
18	0.5	2.0	10.04	9.659
19	1.0	2.0	15.22	14.85
20	1.5	2.0	21.05	20.87

Prob. 15.1 (a) Using the Matlab code in Fig. 15.3, we input the data as:

```
>> plotit( [-1 2 1], [-1 0; 0 2; 1 0], 1, 1, 0.01, 0.01, 8, 2, 5 )
```

and the plot is shown below.

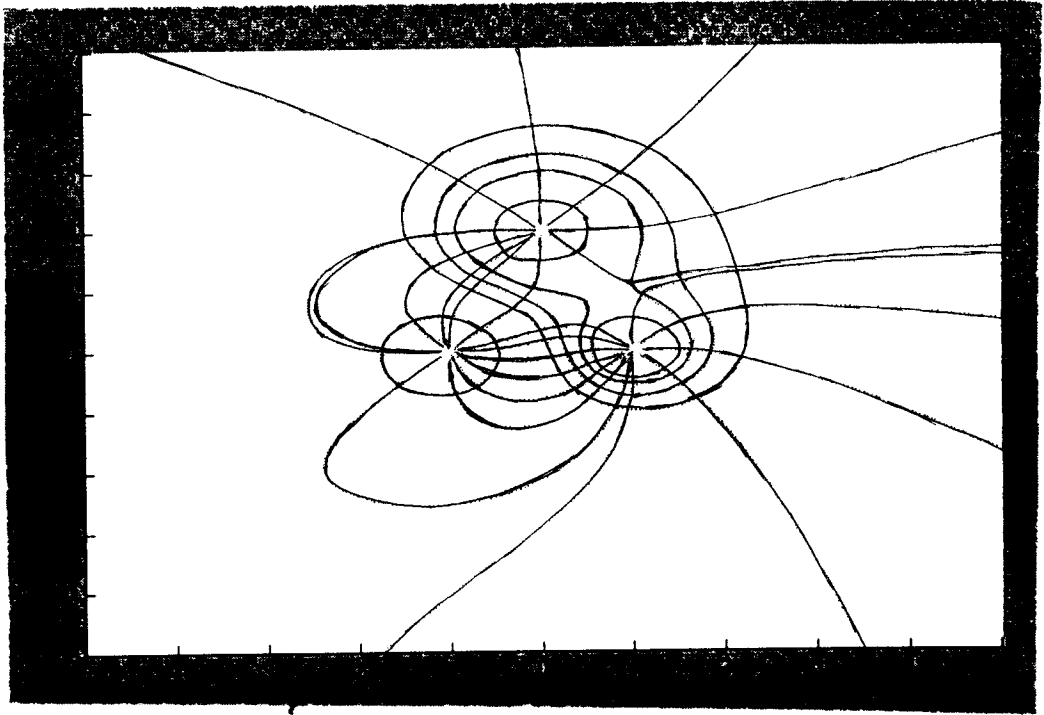

(b) Using the Matlab code in Fig. 15.3, we input the required data as:

```
>> plotit( [1 1 1 1 1], [-1 -1; -1 1; 1 -1; 1 1; 0 0], 1, 1, 0.02, 0.01, 6, 2, 5 )
```

and obtain the plot shown below.

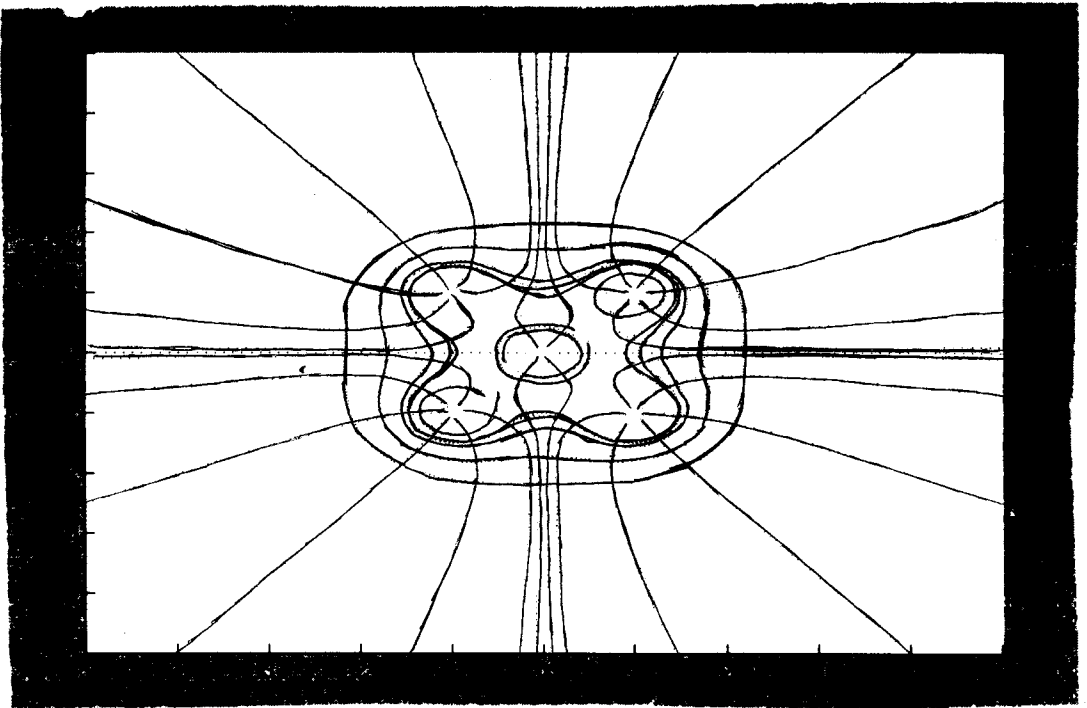

Prob. 15.2Exact solution: $y = Ax + B$

$$x = 0, y = 0 \longrightarrow B = 0; \quad x = 1, y = 10 \longrightarrow A = 10$$

$$y = 10x; \quad y(0.25) = \underline{2.5}$$

Finite difference solution:

$$\frac{d^2y}{dx^2} \cong \frac{y(x + \Delta) - 2y(x) + y(x - \Delta)}{\Delta^2} = 0$$

or

$$y(x) = \frac{1}{2}[y(x + \Delta) + y(x - \Delta)], \Delta = 0.25$$

Using this scheme, we obtain the result shown below.

	0	0.25	0.5	0.75	1.0
Iteration					
0	0	0	0	0	10
1	0	0	0	5	10
2	0	0	2.5	7.5	10
3	0	1.25	5.0	8.75	10
4	0	2.5	5.625	7.5	10
5	0	2.8125	5.0	7.8125	10
6	0	2.5	5.3125	7.5	10
...

From this, we obtain $y(0.25) = \underline{2.5}$.**Prob. 15.3 (a)**

$$\frac{dV}{dx} = \frac{V(x_0 + \Delta x) - V(x - \Delta x)}{2\Delta x}$$

For $\Delta x = 0.05$ and at $x = 0.15$,

$$\frac{dV}{dx} = \frac{2.0134 - 1.00}{0.05 \times 2} = \underline{\underline{10.117}}$$

$$\frac{d^2V}{dx^2} = \frac{V(x + \Delta x) - 2V(x_0) + V(x_0 - \Delta x)}{(\Delta x)^2} = \frac{2.0134 + 1.0017 - 2 \times 1.5056}{(0.05)^2} = \underline{\underline{1.56}}$$

(b) $V = 10 \sinh x$, $dV/dx = 10 \cosh x$. At $x = 0.15$, $dV/dx = \underline{\underline{10.113}}$

which is close to the numerical estimate.

$d^2V/dx^2 = 10 \sinh x$. At $x = 0.15$, $d^2V/dx^2 = \underline{\underline{1.5056}}$

which is lower than the numerical value.

Prob. 15.4

$$\nabla^2 V = \frac{\partial^2 V}{\partial \rho^2} + \frac{1}{\rho} \frac{\partial V}{\partial \rho} + \frac{\partial^2 V}{\partial z^2} = 0$$

The equivalent finite difference expression is

$$\frac{V(\rho_0 + \Delta\rho, z_0) - 2V(\rho_0, z_0) + V(\rho_0 - \Delta\rho, z_0)}{(\Delta\rho)^2} + \frac{1}{\rho_0} \frac{V(\rho_0 + \Delta\rho, z_0) - V(\rho_0 - \Delta\rho, z_0)}{2\Delta\rho} + \frac{V(\rho_0, z_0 + \Delta z) - 2V(\rho_0, z_0) + V(\rho_0, z_0 - \Delta z)}{(\Delta z)^2} = 0$$

If $\Delta z = \Delta\rho = h$, rearranging terms gives

$$V(\rho_0, z_0) = \frac{1}{4}V(\rho_0, z_0 + h) + \frac{1}{4}V(\rho_0, z_0 - h) + \left(1 + \frac{h}{2\rho_0}\right)V(\rho_0 + h, z_0) + \left(1 - \frac{h}{2\rho_0}\right)V(\rho_0 - h, z_0)$$

as expected.

Prob. 15.5

$$\nabla^2 V = \frac{\partial^2 V}{\partial \rho^2} + \frac{1}{\rho} \frac{\partial V}{\partial \rho} + \frac{1}{\rho^2} \frac{\partial^2 V}{\partial \phi^2} = 0. \quad (1)$$

as expected.

Prob. 15.5

$$\nabla^2 V = \frac{\partial^2 V}{\partial \rho^2} + \frac{1}{\rho} \frac{\partial V}{\partial \rho} + \frac{1}{\rho^2} \frac{\partial^2 V}{\partial \phi^2} = 0, \quad (1)$$

$$\frac{\partial^2 V}{\partial \rho^2} = \frac{V_{m+1}^n - 2V_m^n + V_{m-1}^n}{(\Delta \rho)^2}, \quad (2)$$

$$\frac{\partial^2 V}{\partial \phi^2} = \frac{V_m^{n+1} - 2V_m^n + V_m^{n-1}}{(\Delta \phi)^2}, \quad (3)$$

$$\left. \frac{\partial V}{\partial \rho} \right|_{m,n} = \frac{V_{m+1}^n - V_{m-1}^n}{2\Delta \rho}. \quad (4)$$

Substituting (2) to (4) into (1) gives

$$\begin{aligned} \nabla^2 V &= \frac{V_{m+1}^n - V_{m-1}^n}{m\Delta \rho(2\Delta \rho)} + \frac{V_{m+1}^n - 2V_m^n + V_{m-1}^n}{(\Delta \rho)^2} + \frac{V_m^{n+1} - 2V_m^n + V_m^{n-1}}{(m\Delta \rho \Delta \phi)^2} \\ &= \frac{1}{(\Delta \rho)^2} \left[\left(1 - \frac{1}{2m}\right) V_{m-1}^n - 2V_m^n + \left(1 + \frac{1}{2m}\right) V_{m+1}^n + \frac{1}{(m\Delta \phi)^2} (V_m^{n+1} - 2V_m^n + V_m^{n-1}) \right] \end{aligned}$$

as required.

Prob. 15.6

$$V_o = \frac{V_1 + V_2 + V_3 + V_4}{4} = \frac{-10 + 0 + 30 + 60}{4} = \underline{20 \text{ V}}$$

Prob. 15.7

$$V_1 = 0.25(V_2 + 30 + 0 - 20) = V_2/4 + 2.5 \quad (1)$$

$$V_2 = 0.25(V_1 + 20 + 0 + 30) = V_1/4 + 12.5 \quad (2)$$

Substituting (2) into (1),

$$V_1 = 2.5 + V_1/16 + 3.125 \quad \longrightarrow \quad V_1 = \underline{6 \text{ V}}$$

$$\frac{\partial^2 V}{\partial \rho^2} = \frac{V_{m+1}^n - 2V_m^n + V_{m-1}^n}{(\Delta \rho)^2}, \quad (2)$$

$$\frac{\partial^2 V}{\partial \phi^2} = \frac{V_m^{n+1} - 2V_m^n + V_m^{n-1}}{(\Delta \phi)^2}, \quad (3)$$

$$\left. \frac{\partial V}{\partial \rho} \right|_{m,n} = \frac{V_{m+1}^n - V_{m-1}^n}{2\Delta \rho}. \quad (4)$$

Substituting (2) to (4) into (1) gives

$$\begin{aligned} \nabla^2 V &= \frac{V_{m+1}^n - V_{m-1}^n}{m\Delta \rho(2\Delta \rho)} + \frac{V_{m+1}^n - 2V_m^n + V_{m-1}^n}{(\Delta \rho)^2} + \frac{V_m^{n+1} - 2V_m^n + V_m^{n-1}}{(m\Delta \rho\Delta \phi)^2} \\ &= \frac{1}{(\Delta \rho)^2} \left[\left(1 - \frac{1}{2m}\right)V_{m-1}^n - 2V_m^n + \left(1 + \frac{1}{2m}\right)V_{m+1}^n + \frac{1}{(m\Delta \phi)^2}(V_m^{n+1} - 2V_m^n + V_m^{n-1}) \right] \end{aligned}$$

as required.

Prob. 15.6

$$V_o = \frac{V_1 + V_2 + V_3 + V_4}{4} = \frac{-10 + 0 + 30 + 60}{4} = \underline{\underline{20}} \text{ V}$$

Prob. 15.7

$$V_1 = 0.25(V_2 + 30 + 0 - 20) = V_2/4 + 2.5 \quad (1)$$

$$V_2 = 0.25(V_1 + 20 + 0 + 30) = V_1/4 + 12.5 \quad (2)$$

Substituting (2) into (1),

$$V_1 = 2.5 + V_1/16 + 3.125 \quad \longrightarrow \quad V_1 = \underline{\underline{6}} \text{ V}$$

$$V_2 = V_1/4 + 12.5 = \underline{\underline{14}} \text{ V}$$

Prob. 15.8

$$k = \frac{h^2 \rho_o}{\epsilon_o} = \frac{10^{-2} \times \frac{100}{\pi} \times 10^{-9}}{\frac{10^{-9}}{36\pi}} = 36$$

$$V_1 = \frac{1}{4} (V_2 + 30 + 0 + 20 + k) = V_2/4 + 11.5 \quad (1)$$

$$V_2 = \frac{1}{4} (V_1 + 20 + 0 + 30 + k) = V_1/4 + 21.5 \quad (2)$$

Substituting (2) into (1) gives

$$V_1 = 11.5 + V_1/16 + 5.375 \longrightarrow V_1 = \underline{18 \text{ V}}$$

$$V_2 = V_1/4 + 12.5 = \underline{26 \text{ V}}$$

Prob. 15.9 (a)

$$V_1 = \frac{1}{4} (0 + 100 + V_3 + V_2), \quad V_2 = \frac{1}{4} (0 + 100 + V_1 + V_4),$$

$$V_3 = \frac{1}{4} (0 + 0 + V_1 + V_4), \quad V_4 = \frac{1}{4} (0 + 0 + V_2 + V_3)$$

We apply these iteratively $n=5$ times and obtain the result below.

n	0	1	2	3	4	5
V_1	0	25	34.375	36.72	37.305	37.45
V_2	0	31.25	35.937	37.11	37.403	37.475
V_3	0	6.25	10.937	12.11	12.403	12.475
V_4	0	9.375	11.917	12.305	12.45	12.487

(b) By band matrix method,

$$4V_1 - V_2 - V_3 = 100$$

$$-V_1 + 4V_2 - V_4 = 100$$

$$-V_1 + 4V_3 - V_4 = 0$$

$$-V_2 - V_3 + 4V_4 = 0$$

Prob. 15.11 (a) Matrix [A] remains the same. To each term of matrix [B], we add

$$-h^2 \rho_s / \varepsilon.$$

(b) Let $\Delta x = \Delta y = h = 0.05$ so that $NX = 20 = NY$.

$$\frac{\rho_s}{\varepsilon} = \frac{x(y-1)10^{-9}}{10^{-9}/36\pi} = 36\pi x(y-1)$$

Modify the program in Fig. 15.16 as follows.

```
DO 40 I=1, NX-1
DO 40 J=1, NY-1
SAVE = V(I,J)
X = H*FLOAT(I)
Y=H*FLOAT(J)
RO = 36.0*PIE*X*(Y-1)
V(I,J) = 0.25*( V(I+1,J) + V(I-1,J) + V(I,J+1) + V(I,J-1) + H*H*RO )
40 CONTINUE
```

This is the major change. However, in addition to this, we must set

```
V1 = 0.0
V2 = 10.0
V3 = 20.0
V4 = -10.0
NX = 20
NY = 20
```

The results are:

$$\underline{V_a = 4.276, V_b = 9.577, V_c = 11.126, V_d = -2.013, V_e = 2.919,}$$

$$\underline{V_f = 6.069, V_g = -3.424, V_h = -0.109, V_i = 2.909}$$

Prob. 15.12

$$\frac{1}{c^2} \frac{\Phi^{j+1}_{m,n} + \Phi^{j-1}_{m,n} - 2\Phi^j_{m,n}}{(\Delta t)^2} = \frac{\Phi^j_{m+1,n} + \Phi^j_{m-1,n} - 2\Phi^j_{m,n}}{(\Delta x)^2} + \frac{\Phi^j_{m,n+1} + \Phi^j_{m,n-1} - 2\Phi^j_{m,n}}{(\Delta z)^2}$$

If $h = \Delta x = \Delta z$, then after rearranging we obtain

$$\Phi^{j+1}_{m,n} = 2\Phi^{j+1}_{m,n} - \Phi^{j-1}_{m,n} + \alpha(\Phi^j_{m,n} + \Phi^j_{m-1,n} - 2\Phi^j_{m,n})$$

$$\alpha(\Phi^j_{m,n+1} + \Phi^j_{m,n-1} - 2\Phi^j_{m,n})$$

where $\alpha = (c\Delta t / h)^2$.

Prob. 15.13 Applying the finite difference formula derived above, the following programs was developed.

```

        DIMENSION V(0:50,0:50)

        U = 1.0
        DT = 0.1
        DX = 0.1
        NT = 4/DT
        NX = 1/DX
        ALPHA = (U*DT/DX)**2
        DO 10 I=0,NX-1
        DO 10 J=0,NT-1
10      V(I,J) = 0.0
        DO 20 J=0,NT-1
        V(0,J) = 0
        V(10,J) = 0
20      CONTINUE
        DO 30 I=0,NT-1
        V(I,0) = SIN(FLOAT(I-1)*3.142/10.0)
        V(I,1) = V(I,0)
30      CONTINUE
        DO 40 J=1,NT-2
        DO 40 I=1,NX-2
        V(I,J+1) = ALPHA*( V(I-1,J) + V(I+1,J) ) + 2*(1.0 - ALPHA)*V(I,J)
1      - V(I,J-1)
40      CONTINUE

        ...
        WRITE(6,*) V(I,J)

        ...
        STOP
        END

```

The results of the finite difference algorithm agree perfectly with the exact solution as shown below.

T	x	V(FD)	V(exact)
0.0	0.0	0.0	0.0
0.0	0.1	0.30903	0.30902
0.0	0.2	0.58779	0.58779
0.0	0.3	0.80902	0.80902
0.0	0.4	0.95106	0.95106
0.0	0.5	1.0	1.0
0.0	0.6	0.95106	0.95106
0.0	0.7	0.80902	0.80902
...

Prob. 15.14

(a) Points 1, 3, 5, and 7 are equidistant from O. Hence

$$V_o = \frac{1}{4} (V_1 + V_3 + V_5 + V_7) \quad (1)$$

Also points 2, 4, 6, and 8 are equidistant from O so that

$$V_o = \frac{1}{4} (V_2 + V_4 + V_6 + V_8) \quad (2)$$

Adding (1) and (2) gives

$$V_o = \frac{1}{4} (V_1 + V_2 + V_3 + V_4 + V_5 + V_6 + V_7 + V_8)$$

as required.

Prob. 15.15 Combining the ideas in the programs in Figs. 15.20 and 15.24, we develop a Matlab code which gives

$$N = 20 \longrightarrow C = 19.4 \text{ pF/m}$$

$$N = 40 \longrightarrow C = 13.55 \text{ pF/m}$$

$$N = 100 \longrightarrow \underline{C = 12.77 \text{ pF/m}}$$

For the exact value, $d/2a = 50/10 = 5$

$$C = \frac{\pi \epsilon}{\cosh^{-1} \frac{d}{2a}} = \frac{\pi \times 10^{-9} / 36\pi}{\cosh^{-1} 5} = \underline{12.12 \text{ pF/m}}$$

Prob. 15.16 To determine V and E at $(-1,4,5)$, we use the program in Fig. 15.21.

$$V = \int_0^L \frac{\rho_L dl}{4\pi\epsilon_0 R}, \text{ where } R = \sqrt{26 + (4 - y')^2}$$

$$V = \frac{\Delta}{4\pi\epsilon} \sum_{k=1}^N \frac{\rho_k}{\sqrt{26 + (y - y_k)^2}}$$

$$E = \int_0^L \frac{\rho_L dl R}{4\pi\epsilon_0 R^3}$$

where $\mathbf{R} = \mathbf{r} - \mathbf{r}' = (-1, 4 - y', 5)$, $R = |\mathbf{R}|$

$$E_x \cong \frac{\Delta}{4\pi\epsilon} \sum_{k=1}^N \frac{(-1)\rho_k}{[26 + (4 - y_k)^2]^{3/2}}$$

$$E_y \cong \frac{\Delta}{4\pi\epsilon} \sum_{k=1}^N \frac{(4 - y_k)\rho_k}{[26 + (4 - y_k)^2]^{3/2}}$$

$$E_z = -5E_x$$

For $N = 20$, $V_0 = 1V$, $L = 1m$, $a = 1mm$, the following lines are added to the program in the Fortran version of Fig. 15.21 after 90 CONTINUE statement. (See second edition.)

```

V = 0.0
EX = 0.0
EY = 0.0
FACTOR = DELTA/(4.0*PIE*EO)
DO 100 K=1,N
R = SQRT(26.0 + (4.0 - YY(K))**2)
V=V + RO(K)/R
EX = EX - RO(K)/R**3
EY = EY + (4.0 - YY(K))*RO(K)/R**3
100 CONTINUE
V = V*FACTOR
EX = EX*FACTOR
EY = EY*FACTOR
EZ = -5.0*EX
PRINT *, V, EX, EY, EZ
...

```

The result is:

$$V = 12.47 \text{ mV}, \quad \mathbf{E} = -0.3266 \mathbf{a}_x + 1.1353 \mathbf{a}_y + 1.6331 \mathbf{a}_z \text{ mV/m}$$

Prob. 15.17

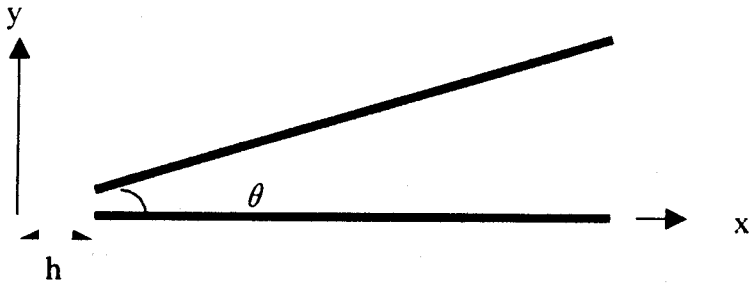

To find C, take the following steps:

- (1) Divide each line into N equal segments. Number the segments in the lower conductor as $1, 2, \dots, N$ and segments in the upper conductor as $N+1, N+2, \dots, 2N$,
- (2) Determine the coordinate (x_k, y_k) for the center of each segment.

For the lower conductor, $y_k = 0, k=1, \dots, N, \quad x_k = h + \Delta (k-1/2), k = 1, 2, \dots, N$

For the upper conductor, $x_k = [h + \Delta (k-1/2)] \sin \theta, k=N+1, N+2, \dots, 2N,$

$$x_k = [h + \Delta (k-1/2)] \cos \theta, \quad k = N+1, N+2, \dots, 2N$$

where h is determined from the gap g as

$$h = \frac{g}{2 \sin \theta / 2}$$

- (3) Calculate the matrices $[V]$ and $[A]$ with the following elements

$$V_k = \begin{cases} V_o, k = 1, \dots, N \\ -V_o, k = N+1, \dots, 2N \end{cases}$$

$$A_{ij} = \begin{cases} \frac{\Delta}{4\pi\epsilon R_{ij}}, i \neq j \\ 2 \ln \Delta / a, i = j \end{cases}$$

$$\text{where } R_{ij} = \sqrt{(x_i - x_j)^2 + (y_i - y_j)^2}$$

- (4) Invert matrix $[A]$ and find $[\rho] = [A]^{-1} [V]$.

(5) Find the charge Q on one conductor

$$Q = \sum \rho_k \Delta = \Delta \sum_{k=1}^N \rho_k$$

(6) Find $C = |Q|/V_o$

Taking $N = 10$, $V_o = 1.0$, a program was developed to obtain the following result.

θ	C (in pF)
10	8.5483
20	9.0677
30	8.893
40	8.606
50	13.004
60	8.5505
70	9.3711
80	8.7762
90	8.665
100	8.665
110	10.179
120	8.544
130	9.892
140	8.7449
150	9.5106
160	8.5488
170	11.32
180	8.6278

Prob. 15.18 We may modify the program in Fig. 15.25 and obtain $Z_o \cong 50\Omega$. For details, see M. N. O. Sadiku, "Numerical Techniques in Electromagnetics," (CRC Press, 1992), pp. 338-340.

Prob. 15.19 (a) Exact solution yields

$$C = 2\pi\epsilon / \ln(\Delta / a) = 8.02607 \times 10^{-11} \text{ F/m and } \underline{Z_o = 41.559\Omega}$$

where $a = 1\text{cm}$ and $\Delta = 2\text{cm}$. The numerical solution is shown below.

N	C (pF/m)	$Z_o (\Omega)$
10	82.386	40.486
20	80.966	41.197
40	80.438	41.467
100	80.025	41.562

(b) For this case, the numerical solution is shown below.

N	C (pF/m)	$Z_o (\Omega)$
10	109.51	30.458
20	108.71	30.681
40	108.27	30.807
100	107.93	30.905

Prob. 15.20 We modify the Matlab code in Fig. 15.26 (for Example 15.5) by changing the input data and matrices [A] and [B]. We let

$$x_i = h + \Delta (i-1/2), \quad i = 1, 2, \dots, N, \quad \Delta = L/N$$

$$y_i = h/2, \quad j = 1, 2, \dots, N, \quad z_k = t/2, \quad k = 1, 2, \dots, N$$

and calculate

$$R_{ij} = \sqrt{(x_i - x_j)^2 + (y_i - y_j)^2 + (z_i - z_j)^2}$$

We obtain matrices [A] and [B]. Inverting [A] gives

$$[q] = [A]^{-1} [B], \quad [\rho_v] = [q]/(ht\Delta), \quad C = \frac{\sum_{i=1}^N q_i}{10}$$

The computed values of $[\rho_v]$ and C are shown below.

i	$\rho_{vi} (x10^{-6}) C / m^3$
1, 20	0.5104
2, 19	0.4524
3, 18	0.4324
4, 17	0.4215
5, 16	0.4144
6, 15	0.4096
7, 14	0.4063
8, 13	0.4041
9, 12	0.4027
10, 11	0.4020

$$C = 17.02 \text{ pF}$$

Prob. 15.21 From given figure, we obtain

$$\alpha_1 = \frac{A_1}{A} = \frac{1}{2A} \begin{vmatrix} 1 & x & y \\ 1 & x_2 & y_2 \\ 1 & x_3 & y_3 \end{vmatrix} = \frac{1}{2A} [(x_2 y_3 - x_3 y_2) + (y_2 - y_3)x + (x_3 - x_2)y]$$

as expected. The same applies for α_2 and α_3 .

Prob. 15.22 (a) For the element in (a),

$$A = \frac{1}{2} (1 - 0.5 \times 0.25) = 0.4375$$

$$\alpha_1 = \frac{1}{2A} [0.875 - 0.75x - 0.5y] = 1 - 0.8571x - 0.5714y$$

$$\alpha_2 = \frac{1}{2A} [0 + x - 0.5y] = 1.1428x - 0.5714y$$

$$\alpha_3 = \frac{1}{2A} [0 - 0.25x + y] = -0.2857x + 1.1429y$$

For the element in (b),

$$A = \frac{1}{2} [0.5 \times 1.6 - (-1) \times 1.6] = 1.2$$

$$\alpha_1 = 1.25 - 0.625y$$

$$\alpha_2 = -1.5 + 0.667x + 0.4167y$$

$$\alpha_3 = 1.25 - 0.667x + 0.2083y$$

(b) For the element in (a),

$$P_1 = -0.75, P_2 = 1.0, P_3 = -0.25, Q_1 = -0.5 = Q_2, Q_3 = 1.0$$

$$C_{ij} = \frac{1}{4A} [P_i P_j + Q_i Q_j] = (\nabla \alpha_1 \cdot \nabla \alpha_2) A$$

Hence,

$$C^{(1)} = \begin{bmatrix} 0.4643 & -0.2857 & -0.1786 \\ -0.2857 & 0.7143 & -0.4286 \\ -0.1786 & -0.4286 & 0.6071 \end{bmatrix}$$

For the element in (b),

$$P_1 = 0, P_2 = 1.6, P_3 = -1.6, Q_1 = -1.5, Q_2 = 1.0, Q_3 = 0.5$$

Hence,

$$C^{(2)} = \begin{bmatrix} 0.4688 & -0.3125 & -0.1553 \\ -0.3125 & 0.7417 & -0.4292 \\ -0.1563 & -0.4292 & 0.5854 \end{bmatrix}$$

Prob. 15.23 (a)

$$2A = \begin{vmatrix} 1 & 1/2 & 1/2 \\ 1 & 3 & 1/2 \\ 1 & 2 & 2 \end{vmatrix} = 15/4$$

$$\alpha_1 = \frac{4}{15}[(6-1) + (-1\frac{1}{2})x + (-1)y] = \frac{4}{15}(5 - 1.5x - y)$$

$$\alpha_2 = \frac{4}{15}[(1-1) + \frac{3}{2}x - \frac{3}{2}y] = \frac{4}{15}(1.5x - 1.5y)$$

$$\alpha_3 = \frac{4}{15}[(1/4 - 3/2) + 0x + \frac{5}{2}y] = \frac{4}{15}(-1.25 + 2.5y)$$

$$V = \alpha_1 V_1 + \alpha_2 V_2 + \alpha_3 V_3$$

Substituting $V=80$, $V_1 = 100$, $V_2 = 50$, $V_3 = 30$, α_1 , α_2 , and α_3 leads to

$$20 = 7.5x + 10y + 3.75$$

Along side 12, $y=1/2$ so that

$$20 = 15x/2 + 5 + 15/4 \longrightarrow x=3/2, \text{ i.e. } (1.5, 0.5)$$

Along side 13, $x=y$

$$20 = 15x/2 + 10x + 15/4 \longrightarrow x=13/4, \text{ i.e. } (13/4, 13/4)$$

Along side 23, $y = -3x/2 + 5$

$$20 = 15x/2 - 15 + 50 + 15/4 \longrightarrow x = -5/2 \text{ (not possible)}$$

Hence intersection occurs at

(1.5, 0.5) along 12 and (0.9286, 0.9286) along 13

(b) At (2,1),

$$\alpha_1 = \frac{4}{15}, \alpha_2 = \frac{6}{15}, \alpha_3 = \frac{5}{15}$$

$$V(1,2) = \alpha_1 V_1 + \alpha_2 V_2 + \alpha_3 V_3 = (400 + 300 + 150)/15 = \underline{56.67 \text{ V}}$$

Prob. 15.24

$$2A = \begin{vmatrix} 1 & 0 & 0 \\ 1 & 2 & -1 \\ 1 & 1 & 4 \end{vmatrix} = 9$$

$$\alpha_1 = \frac{1}{9}[(0-0) + (4-0)x + (0-1)y] = \frac{1}{9}(4x - y)$$

$$\alpha_2 = \frac{1}{9}[(0-0) + (0+1)x + (2-0)y] = \frac{1}{9}(x + 2y)$$

$$\alpha_3 = \frac{1}{9}[(8+1) + (-1-4)x + (1-2)y] = \frac{1}{9}(9 - 5x - y)$$

$$V_e = \alpha_1 V_{e1} + \alpha_2 V_{e2} + \alpha_3 V_{e3}$$

$$V(1,2) = 8(4-2)/9 + 12(1+4)/9 + 10(9-5-1)/9 = 96/9 = \underline{10.667 \text{ V}}$$

At the center $\alpha_1 = \alpha_2 = \alpha_3 = 1/3$ so that

$$V(\text{center}) = (8 + 12 + 10)/3 = 10$$

Or at the center, $(x, y) = (0 + 1 + 2, 0 + 4 - 1)/3 = (1, 1)$

$$V(1,1) = 8(3)/9 + 12(3)/9 + 10(3)/9 = 10 \text{ V}$$

Prob. 15.25

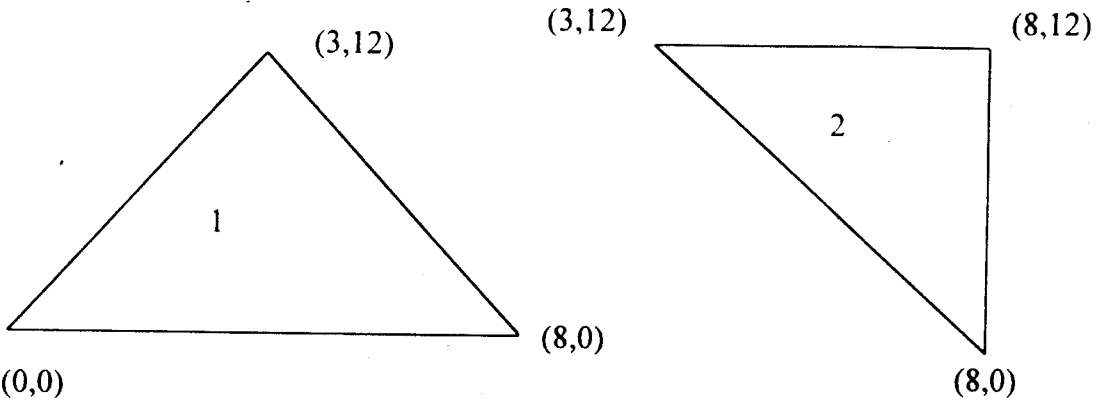

For element 1, local numbering 1-2-3 corresponds to global numbering 4-2-1.

$$P_1 = 12, P_2 = 0, P_3 = -12, Q_1 = -3, Q_2 = 8, Q_3 = -5,$$

$$A = (0 + 12 \times 8)/2 = 48$$

$$C_y = \frac{1}{4 \times 48} [P_i P_i + Q_i Q_i]$$

$$C^{(1)} = \begin{bmatrix} 0.7956 & -0.1248 & -0.6708 \\ -0.1248 & 0.3328 & -0.208 \\ -0.6708 & -0.208 & 0.8788 \end{bmatrix}$$

For element 2, local numbering 1-2-3 corresponds to global numbering 2-4-3.

$$P_1 = -12, P_2 = 0, P_3 = 12, Q_1 = 0, Q_2 = -5, Q_3 = 5,$$

$$A = (0 + 60)/2 = 30$$

$$C_y = \frac{1}{4 \times 48} [P_i P_i + Q_i Q_i]$$

$$C^{(1)} = \begin{bmatrix} 1.2 & 0 & -1.2 \\ 0 & 0.208 & -0.208 \\ -1.2 & -0.208 & 1.408 \end{bmatrix}$$

$$C = \begin{bmatrix} C_{33}^{(1)} & C_{23}^{(1)} & 0 & C_{31}^{(1)} \\ C_{23}^{(1)} & C_{22}^{(1)} + C_{11}^{(2)} & C_{13}^{(2)} & C_{21}^{(1)} + C_{12}^{(2)} \\ 0 & C_{31}^{(2)} & C_{33}^{(2)} & C_{32}^{(2)} \\ C_{13}^{(1)} & C_{21}^{(1)} + C_{21}^{(2)} & C_{23}^{(2)} & C_{22}^{(2)} + C_{11}^{(1)} \end{bmatrix}$$

$$= \begin{bmatrix} 0.8788 & -0.208 & 0 & -0.6708 \\ -0.208 & 1.528 & -1.2 & -0.1248 \\ 0 & -1.2 & 1.408 & -0.206 \\ -0.6708 & -0.1248 & -0.208 & 1.0036 \end{bmatrix}$$

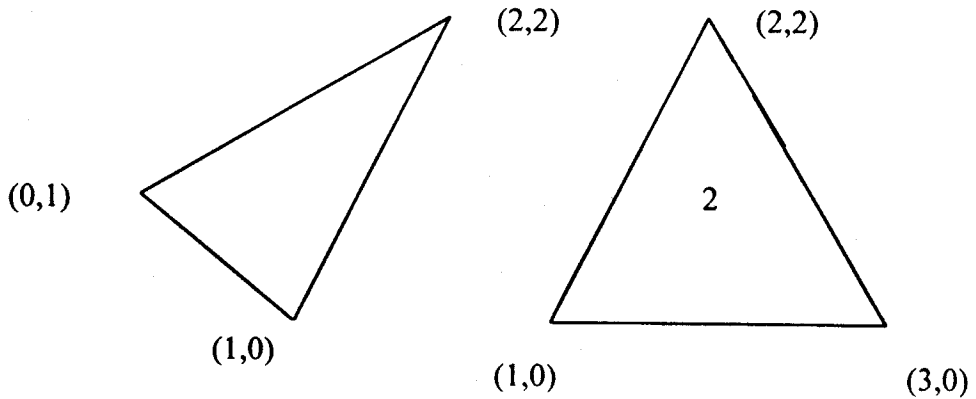
Prob. 15.26

For element 1, local numbering 1-2-3 corresponds to global numbering 1-2-4.

$$P_1 = -2, P_2 = 1, P_3 = -1; Q_1 = 1, Q_2 = -2, Q_3 = 1,$$

$$A = (P_2 Q_3 - P_3 Q_2) / 2 = 3/2, \text{ i.e. } 4A = 6$$

$$C_{ij} = \frac{1}{4A} [P_i P_j + Q_i Q_j]$$

$$C^{(1)} = \frac{1}{6} \begin{bmatrix} 5 & -4 & -1 \\ -4 & 5 & -1 \\ -1 & -1 & 2 \end{bmatrix}$$

For element 2, local numbering 1-2-3 corresponds to global numbering 4-2-3.

$$P_1 = 0, P_2 = -2, P_3 = 2, Q_1 = 2, Q_2 = -1, Q_3 = -1,$$

$$A = 2, \quad 4A = 8$$

$$C^{(2)} = \frac{1}{8} \begin{bmatrix} 4 & -2 & -2 \\ -2 & 5 & -3 \\ -2 & -3 & 5 \end{bmatrix}$$

The global coefficient matrix is

$$C = \begin{bmatrix} C_{11}^{(1)} & C_{12}^{(1)} & 0 & C_{13}^{(1)} \\ C_{12}^{(1)} & C_{22}^{(1)} + C_{22}^{(2)} & C_{23}^{(2)} & C_{23}^{(1)} + C_{21}^{(2)} \\ 0 & C_{23}^{(2)} & C_{33}^{(2)} & C_{31}^{(2)} \\ C_{13}^{(1)} & C_{23}^{(1)} + C_{21}^{(2)} & C_{31}^{(2)} & C_{33}^{(1)} + C_{11}^{(2)} \end{bmatrix}$$

$$= \begin{bmatrix} 0.8333 & -0.667 & 0 & -0.1667 \\ -0.6667 & 1.4583 & -0.375 & -0.4167 \\ 0 & -0.375 & 0.625 & -0.25 \\ -0.1667 & -0.4167 & -0.25 & 0.833 \end{bmatrix}$$

Prob. 15.27 We can do it by hand as in Example 15.6. However, it is easier to prepare an input files and use the program in Fig. 15.54. The Matlab input data is

```
NE = 2;
ND = 4;
NP = 2;
NL = [1 2 4
      2 3 4];
X = [0.0 1.0 3.0 2.0];
Y = [1.0 0.0 0.0 2.0];
NDP = [1 3];
VAL = [10.0 30.0]
```

The result is $V = \begin{bmatrix} 10 \\ 18 \\ 30 \\ 20 \end{bmatrix}$

From this,

$$V_2 = 18 \text{ V}, \quad V_4 = 20 \text{ V}$$

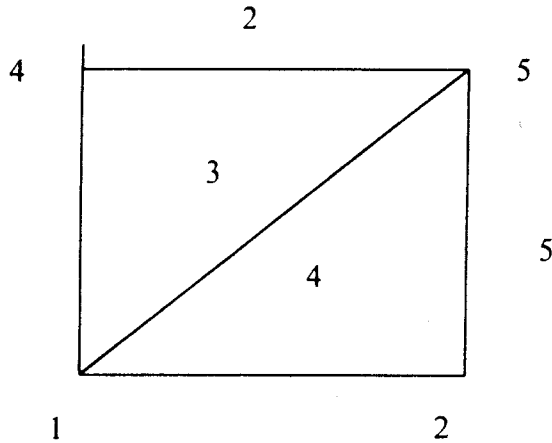
Prob. 15.28

The local numbering 1-2-3 in element 3 corresponds with the global numbering 5-4-1, while the local number 1-2-3 in element 4 corresponds with the global numbering 5-1-2.

$$C_{5,5} = C_{11}^{(2)} + C_{11}^{(3)} + C_{11}^{(4)} + C_{11}^{(5)}, \quad A = 2,$$

$$C_{11}^{(2)} = (2 \times 2 + 2 \times 2)/8 = 1 = C_{11}^{(5)}$$

$$C_{11}^{(3)} = (2 \times 2 + 0)/8 = \frac{1}{2} = C_{11}^{(4)}$$

$$C_{5,5} = 1 + 1 + \frac{1}{2} + \frac{1}{2} = \underline{3}$$

$$C_{5,1} = C_{31}^{(3)} + C_{21}^{(4)}$$

$$\text{But } C_{31}^{(3)} = \frac{1}{8} (P_3 P_1 + Q_3 Q_1) = 0 \text{ since } P_3 = 0 = Q_3$$

$$C_{21}^{(4)} = \frac{1}{8} (P_2 P_1 + Q_2 Q_1) = 0 \text{ since } P_3 = 0 = Q_3$$

$$\underline{C_{5,1} = 0}$$

Prob. 15.29 As in P. E. 14.7, we use the program in Fig. 15.34. The input data based on Fig. 15.56 is as follows.

$$NE = 50; \quad ND = 36; \quad NP = 20;$$

$$NL = \begin{bmatrix} 1 & 8 & 7 \\ 1 & 2 & 8 \\ 2 & 9 & 8 \\ 2 & 3 & 9 \\ 3 & 10 & 9 \\ 3 & 4 & 10 \end{bmatrix}$$

4	11	10
4	5	11
5	12	11
5	6	12
7	14	13
7	8	14
8	15	14
8	9	15
9	16	15
9	16	16
10	17	16
10	11	17
11	18	17
11	12	18
13	20	19
13	14	20
14	21	20
14	15	21
15	22	21
15	16	22
16	23	22
16	17	23
17	24	23
17	18	24
19	26	25
19	20	26
20	27	26
20	21	27
21	28	27
21	22	28
22	29	28
22	23	29
23	30	29
23	24	30
25	32	31
25	26	32
26	33	32
26	27	33
27	34	33
27	28	34
28	35	34
28	29	35
29	36	35
29	30	36];

$X = [0.0 \ 0.2 \ 0.4 \ 0.6 \ 0.8 \ 1.0 \ 0.0 \ 0.2 \ 0.4 \ 0.6 \ 0.8 \ 1.0 \ 0.0 \ 0.2 \ 0.4 \ 0.6 \ 0.8 \ 1.0$
 $0.0 \ 0.2 \ 0.4 \ 0.6 \ 0.8 \ 1.0 \ 0.0 \ 0.2 \ 0.4 \ 0.6 \ 0.8 \ 1.0 \ 0.2 \ 0.4 \ 0.6 \ 0.8 \ 1.0];$

$Y = [0.0 \ 0.0 \ 0.0 \ 0.0 \ 0.0 \ 0.0 \ 0.2 \ 0.2 \ 0.2 \ 0.2 \ 0.2 \ 0.2 \ 0.4 \ 0.4 \ 0.4 \ 0.4 \ 0.4$
 $0.4 \ 0.6 \ 0.6 \ 0.6 \ 0.6 \ 0.6 \ 0.6 \ 0.8 \ 0.8 \ 0.8 \ 0.8 \ 0.8 \ 0.8 \ 1.0 \ 1.0 \ 1.0 \ 1.0 \ 1.0 \ 1.0];$
 $NDP = [1 \ 2 \ 3 \ 4 \ 5 \ 6 \ 12 \ 18 \ 24 \ 30 \ 36 \ 35 \ 34 \ 33 \ 32 \ 31 \ 25 \ 19 \ 13 \ 7];$
 $VAL = [0.0 \ 0.0 \ 0.0 \ 0.0 \ 0.0 \ 0.0 \ 0.0 \ 0.0 \ 0.0 \ 0.0 \ 0.0 \ 0.0 \ 50.0 \ 100.0 \ 100.0 \ 100.0$
 $100.0 \ 50.0 \ 0.0 \ 0.0 \ 0.0];$

With this data, the potentials at the free nodes are compared with the exact values as shown below.

Node no.	FEM Solution	Exact Solution
8	4.546	4.366
9	7.197	7.017
10	7.197	7.017
11	4.546	4.366
14	10.98	10.66
15	17.05	16.8
16	17.05	16.84
17	10.98	10.60
20	22.35	21.78
21	32.95	33.16
22	32.95	33.16
23	22.35	21.78
26	45.45	45.63
27	59.49	60.60
28	59.49	60.60
29	45.45	45.63

Prob. 15.30 We use exactly the same input data as in the previous problem except that the last few lines are replaced by the following lines.

$VAL = [0.0 \ 0.0 \ 0.0 \ 0.0 \ 0.0 \ 0.0 \ 0.0 \ 0.0 \ 0.0 \ 0.0 \ 0.0 \ 58.8 \ 100.0 \ 95.1 \ 95.1$
 $58.8 \ 0.0 \ 0.0 \ 0.0];$

The potential at the free nodes obtained with the input data are compared with the exact solution as shown below.

Node no.	FEM Solution	Exact Solution
8	3.635	3.412
9	5.882	5.521
10	5.882	5.521
11	3.635	3.412
14	8.659	8.217
15	14.01	13.30
16	14.01	13.30
17	8.659	8.217
20	16.99	16.37
21	27.49	26.49
22	27.49	26.49
23	16.69	16.37
26	31.81	31.21
27	51.47	50.5
28	51.49	50.5
29	31.81	31.21

Prob. 15.31

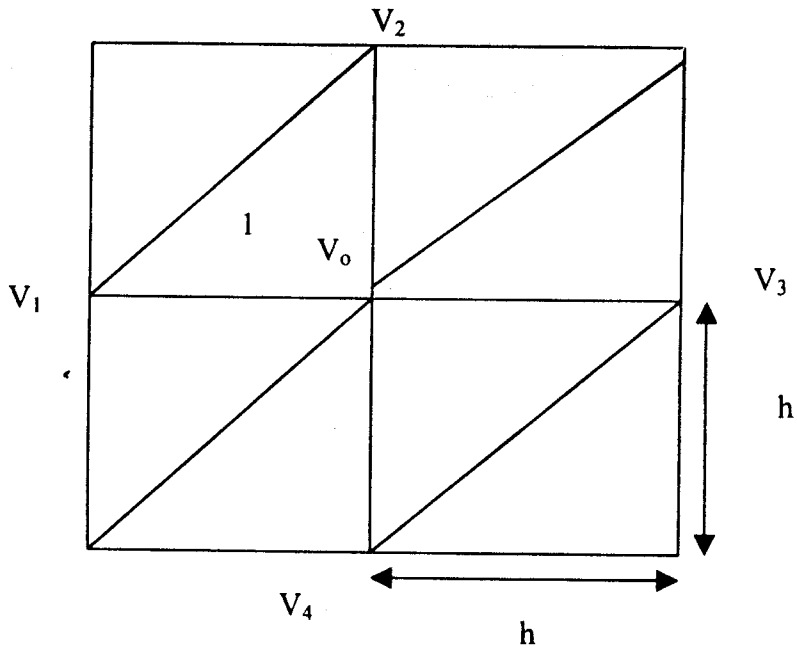

For element 1, the local numbering 1-2-3 corresponds with nodes with V_1 , V_2 , and V_3 .

$$V_0 = -\frac{1}{C_{00}} \sum_{i=1}^4 V_i C_{i0}$$

$$C_{oo} = \sum_{j=1}^4 C_{oj}^{(e)} = \frac{1}{4h^2/2}(hh+hh)x_2 + \frac{1}{4h^2/2}(hh+0)x_4 = 4$$

$$C_{o1} = \frac{2x_1}{2h^2}[P_3P_1 + Q_3Q_1] = \frac{2}{2h^2}[-hh - 0] = -1$$

$$C_{o2} = \frac{2x_1}{2h^2}[P_1P_2 + Q_1Q_2] = \frac{2}{2h^2}[-hx_0 + hx(-h)] = -1$$

Similarly, $C_{o3} = -1 = C_{o4}$. Thus

$$V_o = (V_1 + V_2 + V_3 + V_4)/4$$

which is the same result obtained using FDM.